

MAXIM

4 Digit Up/Down Counter/Decoder/Driver

MM74C945/947

General Description

The MM74C945 and MM74C947 are synchronous 4 digit up/down counters with latches, 7-segment decoders, and all segment and backplane driver, and oscillator circuitry necessary to directly drive LCD displays.

Maxim's MM74C945 has a select input which allows the counter contents or the latch contents to be displayed, and a blanking input which allows the display to be blanked.

The MM74C947 only displays the latch contents, but provides leading zero blanking. The leading zero blanking input allows the user to force leading zeros to be displayed, and the leading zero output allows cascaded counters to blank leading zeroes properly.

Both devices provide 28 segment outputs and a backplane input/output. When the oscillator pin is open, the device generates its own display waveform timing. When the oscillator pin is grounded, the backplane pin becomes an input.

The MM74C945 and MM74C947 are available in a 44 lead plastic chip carrier package in addition to the standard 40 lead plastic DIP.

Applications

Unit Counter Hour Meter
 Frequency Counter Totalizer
 Tachometer

Typical Operating Circuit

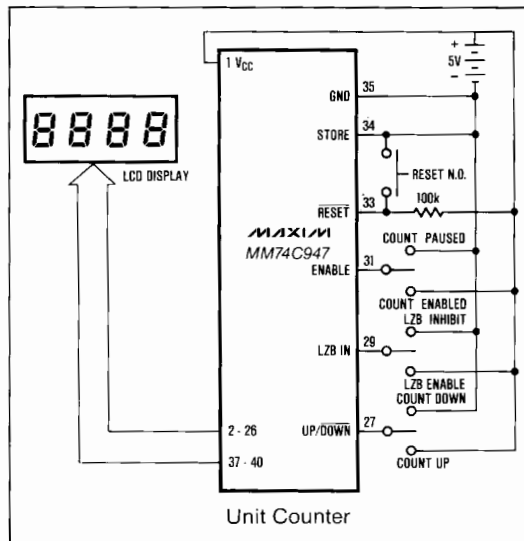

Features

- ◆ 4 Decade Synchronous Up/Down Counter
- ◆ All Circuitry for Segments and Backplane of 4-Digit LCD
- ◆ Carry/Borrow Output Allows Ripple or Synchronous Cascading
- ◆ Schmitt Trigger Count Input
- ◆ Store and Reset Inputs Allow Operation as Frequency or Period Counter
- ◆ MM74C945 Provides Input to Select Display of Counter or Latch
- ◆ MM74C947 Provides Leading Zero Blanking Input and Output. Least Significant Digit May be Blanked.

Ordering Information

PART	TEMP. RANGE	PACKAGE
MM74C945N	-40°C to +85°C	40 Lead Plastic DIP
MM74C945CQH	0°C to +70°C	44 Lead Plastic Chip Carrier
MM74C945C/D	0°C to +70°C	Dice
MM74C947N	-40°C to +85°C	40 Lead Plastic DIP
MM74C947CQH	0°C to +70°C	44 Lead Plastic Chip Carrier
MM74C947C/D	0°C to +70°C	Dice

Pin Configuration

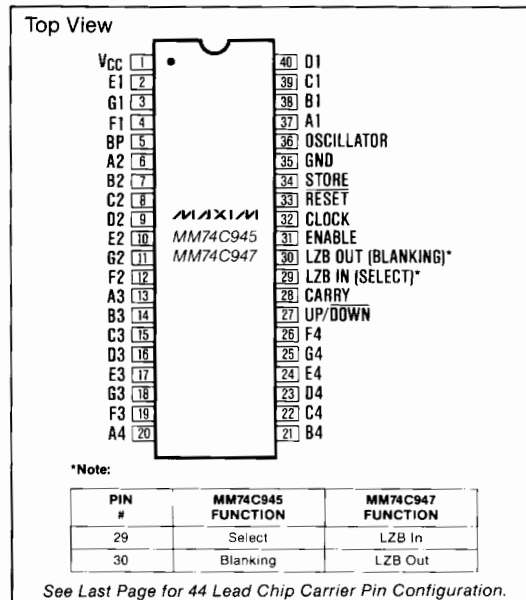

4 Digit Up/Down Counter/Decoder/Driver

ABSOLUTE MAXIMUM RATINGS

Supply Voltage	6.5V	Operating V_{CC} Range	3.0V to 6.0V
Input Voltage	-0.3V to V^+ +0.3V	Operating Temperature Range	-40°C to +85°C
Power Dissipation		Storage Temperature Range	-65°C to +160°C
40 Lead Plastic Dip	0.5W	Lead Temperature (Soldering, 10 sec.)	+300°C
44 Lead Plastic Chip Carrier	0.5W		

Stresses above those listed under "Absolute Maximum Ratings" may cause permanent damage to the device. These are stress ratings only and functional operation of the device at these or any other conditions above those indicated in the operational sections of the specifications is not implied. Exposure to absolute maximum rating conditions for extended periods may affect device reliability.

ELECTRICAL CHARACTERISTICS

Min/max limits apply across temperature range, unless otherwise noted.

PARAMETER	CONDITIONS	MIN	TYP	MAX	UNITS
CMOS TO CMOS					
V_T , Positive Going Threshold Voltage (Clock Only)	$V_{CC} = 5V, V_{IN} (0 \rightarrow 5) V$	2.5	2.9	3.25	V
V_T , Negative Going Threshold Voltage (Clock Only)	$V_{CC} = 5V, V_{IN} (5 \rightarrow 0) V$	1.5	2.2	2.4	V
Hysteresis ($V_{T+} - V_{T-}$) (Clock Only)	$V_{CC} = 5V$	0.1	0.7	1.75	V
Logical "1" Input Voltage ($V_{IN(1)}$)	$V_{CC} = 5V$	3.5			V
Logical "0" Input Voltage ($V_{IN(0)}$)	$V_{CC} = 5V$			1.5	V
Logical "1" Output Voltage ($V_{OUT(1)}$) (LZO and Carry)	$V_{CC} = 5V, I_O = -10 \mu A$	4.5			V
Logical "0" Output Voltage ($V_{OUT(0)}$) (LZO and Carry)	$V_{CC} = 5V, I_O = +10 \mu A$			0.5	V
Clock Input Current $ I_{IN} $	$V_{CC} = 5V, V_{IN} = 5V/0V$		0.005	1.0	μA
Input Current @ Pins 27, 29, 31, 33, and 34 (Note 1)	$V_{CC} = 5V, V_{IN} = 0V$ $V_{IN} = 5V$			± 1.0 ± 1.0	μA μA
Oscillator Input Current (I_{OSL})	$V_{CC} = 5V, V_{IN} = 0V/5V$		± 5	± 15.0	μA
Supply Current (I_{CC}) (Note 2)	$V_{CC} = 5V, V_{IN} = 0V/5V$		10	60	μA
Oscillator Input Voltage $V_{IH(OSC)}$ $V_{IL(OSC)}$	When Driving Oscillator Pin with External Signal	0.2 V_{CC}		$V_{CC} - 0.2$	V V
DC Offset Voltage (Note 3)	$V_{CC} = 5V$			25	mV
CMOS/LPTTL INTERFACE					
Logical "1" Input Voltage ($V_{IN(1)}$)	$V_{CC} = 4.75V$	$V_{CC} - 1.5V$			V
Logical "0" Input Voltage ($V_{IN(0)}$)	$V_{CC} = 4.75V$			0.8	V
Logical "1" Output Voltage ($V_{OUT(1)}$) (LZO and Carry)	$V_{CC} = 4.75V, I_O = -360 \mu A$	2.4			V
Logical "0" Output Voltage ($V_{OUT(0)}$) (LZO and Carry)	$V_{CC} = 4.75V, I_O = +360 \mu A$			0.4	V
OUTPUT DRIVE (SHORT CIRCUIT CURRENT)					
Output Source Current (I_{SOURCE}) (LZO and Carry)	$V_{CC} = 5V, V_{OUT} = 0V$ $T_A = 25^\circ C$	1.75	2.7		mA
Output Sink Current (I_{SINK}) (LZO and Carry)	$V_{CC} = 5V, V_{OUT} = 5V$ $T_A = 25^\circ C$	1.75	3.2		mA
Output Source Current (I_{SOURCE}) (Segment Outputs)	$V_{CC} = 5V, V_{OUT} = 0V$ $T_A = 25^\circ C$	1.4	2.0		mA
Output Sink Current (I_{SINK}) (Segment Output)	$V_{CC} = 5V, V_{OUT} = 5V$ $T_A = 25^\circ C$	1.4	2.2		mA
Output Source Current (I_{SOURCE}) (Backplane Output)	$V_{CC} = 5V, V_{OUT} = 0V$ $T_A = 25^\circ C$	12.6	15.0		mA
Output Sink Current (I_{SINK}) (Backplane Output)	$V_{CC} = 5V, V_{OUT} = 5V$ $T_A = 25^\circ C$	12.6	20.0		mA

Note 1: Does not apply to backplane and oscillator pins. Does apply to pin 30 on MM74C945.

Note 2: Display blanked. See Test Circuit.

Note 3: DC offset voltage is the effective DC voltage the LCD will have between any segment and the backplane.

4 Digit Up/Down Counter/Decoder/Driver

MM74C945/947

AC ELECTRICAL CHARACTERISTICS

$T_j = 25^\circ\text{C}$, $C_L = 50\text{ pF}$, unless otherwise specified.

PARAMETER	SYMBOL	CONDITIONS	MIN	TYP	MAX	UNITS
Propagation Delay Clock to Carry	t_{pd0}, t_{pd1}	$V_{CC} = 5.0\text{V}$ (Note 2)		600	800	ns
Maximum Clock Frequency	f_{CLK}	$V_{CC} = 5.0\text{V}$	2	3		MHz
Clock Input Rise/Fall Time	t_r, t_f	$V_{CC} = 5.0\text{V}$			No Limit	
Reset Pulse Width	t_{WR}	$V_{CC} = 5.0\text{V}$	180	50		ns
Store Pulse Width	t_{WS}	$V_{CC} = 5.0\text{V}$	150	50		ns
Clock to Store Set-Up Time	$t_{SU(CK, S)}$	$V_{CC} = 5.0\text{V}$	500	120		ns
Store to Reset Wait Time	t_{SR}	$V_{CC} = 5.0\text{V}$	280	170		ns
Enable to Clock Set-Up Time	$t_{SU(E, CK)}$	$V_{CC} = 5.0\text{V}$ (Note 3)	600	400		ns
Reset Removal	t_{RR}	$V_{CC} = 5.0\text{V}$	50	0		ns
Up/Down to Clock Set-Up Time	$t_{SU(U/D, CK)}$	$V_{CC} = 5.0\text{V}$ (Note 4)	600	400		ns
Backplane Output Frequency	f_{BP}	Pin 36 Floating, $V_{CC} = 5.0\text{V}$		85		Hz
Input Capacitance	C_{IN}	Logic Inputs (Note 1)		5		pF
Segment Rise/Fall Time	t_{rs}	$C_{Load} = 200\text{ pF}$		0.5		μS
Backplane Rise/Fall Time	t_{rb}	$C_{Load} = 5000\text{ pF}$		1.5		μS
Oscillator Frequency	f_{OSC}	Pin 36 Floating, $V_{CC} = 5.0\text{V}$		11		kHz
Propagation Delay Enable to Carry	$t_{pd}(E, C)$	$V_{CC} = 5.0\text{V}$		450		ns

Note 1: Does not apply to backplane and oscillator pins. Does apply to pin 30 on MM74C945.

Note 2: National's MM74C945/947 is specified at 600ns maximum.

Note 3: National's MM74C945/947 is specified at 140ns minimum.

Note 4: National's MM74C945/947 is specified at 300ns maximum.

AC Waveforms

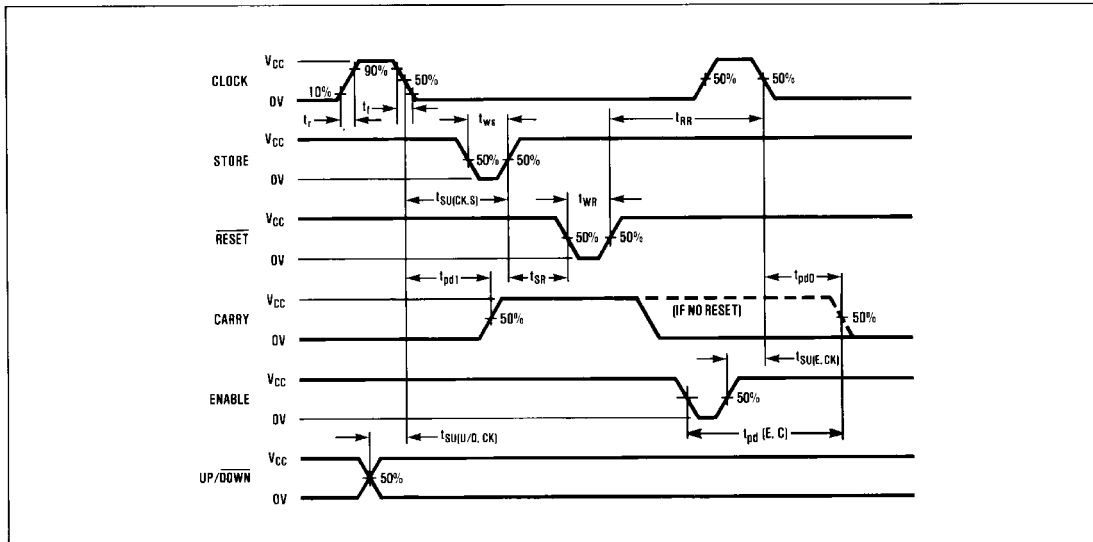

4 Digit Up/Down Counter/Decoder/Driver

TABLE 1. PIN DESCRIPTIONS
(Pin numbers correspond to 40 lead DIP package)

PIN	FUNCTION	DESCRIPTION
1	V _{CC}	Positive power supply
2-4 6-26 37-40	Segment Outputs	These 28 pins directly drive LCD display segments. Segments A1-G1 drive the least significant digit, segments A4-G4 drive the 1000s digit.
5	BACKPLANE	The backplane pin is both an input and an output. As an output it drives the LCD backplane with an internally generated backplane signal. The backplane pin is an input when the slave mode is selected by grounding pin 36, Oscillator.
27	UP/DOWN	This input controls the direction of counting. When high, counter counts up, when low, down.
28	CARRY	The CARRY output goes high when the ENABLE input is high and the counter is at 9999 counting up or at 0000 counting down. When the ENABLE input is low CARRY is low. This output may be used to ripple or synchronously cascade counters.
29	SELECT	When high, counter contents displayed. When low, latch contents displayed. MM74C945 only.
30	BLANKING	When high, entire display is blanked. MM74C945 only.
29	LZB IN	The MM74C947 displays leading zeroes when this pin is grounded. Connecting this pin to V _{CC} enables leading zero blanking. The entire display will be blanked if this pin is high, the counter is at 0000, and the oscillator pin is grounded. If the oscillator pin is floating, the least significant digit A1-G1 will not blank. MM74C947 only.
30	LZB OUT	This output allows the proper blanking of cascaded counters. The LZB OUT goes high when all digits are blanked. MM74C947 only.
31	ENABLE	When this input is low, the counter is inhibited and the CARRY output will be low. When this input is high, the counter is enabled.
32	CLOCK	Every negative-going transition at the CLOCK input clocks the counter. This input has a Schmitt trigger to prevent multiple clocking with slow rate-of-fall inputs.
33	RESET	A low level at this input will reset the counter to 0000. This input is inactive when high.
34	STORE	When the STORE input is low, the latches are transparent and the counter contents are displayed. When this input is high, the data is latched.
35	GROUND	The negative power supply input.
36	OSCILLATOR	When this pin is left floating, the chip oscillator will free-run at approximately 11kHz. Connecting an external capacitor between this pin and either power supply will lower the oscillator frequency as shown in the Typical Characteristics graphs. The oscillator may be overdriven but care must be taken to avoid swinging too close to ground. Grounding this pin puts the chip into the backplane slave mode making pin 5, BACKPLANE, into an input, and on the MM74C947 allowing the least significant digit to leading zero blank.

TABLE 1. TYPICAL LCD DISPLAYS

MANUFACTURER	PART NUMBER	DIGIT HEIGHT	NUMBER OF DIGITS
Epson (213) 534-0360	LD-H7924	0.350"	4½
	LD-H7916	0.500"	4
	LD-K7994	0.700"	4
LXD (216) 292-3300	44D3F-85	0.800"	4½
	44D3F-45	0.400"	4½
Hamlin (414) 648-2361	3909	0.400"	4½
	3912	0.800"	4½
AND (415) 347-9916	FE0202W-DU	0.500"	4
	FE0206W-DU	0.400"	4½

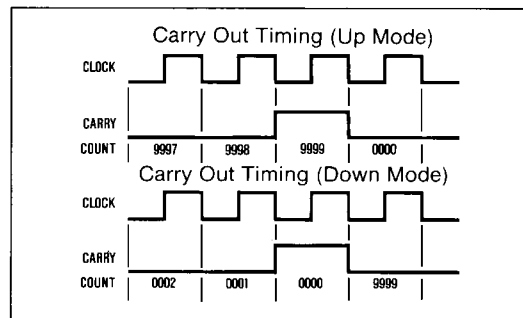

Figure 1. Carry Timing

4 Digit Up/Down Counter/Decoder/Driver

Applications Information

Display Drive Circuitry Description

The MM74C945 and MM74C947 have 28 segment outputs and a backplane input-output which directly drive a 4-digit seven-segment LCD display. The segment and backplane drivers are designed to provide matched rise and fall times which eliminates any DC component of the display signals maximizing display life.

The backplane driver may be disabled by connecting the oscillator pin to ground. In this mode, the backplane pin becomes an input, and the display waveforms will be synchronized with the signal applied to the pin. Several chips may be ganged in this manner, allowing the use of single-backplane displays with four, eight, twelve, etc. digits where one four-digit counter drives the backplane and the rest are slaved to it.

On the MM74C947, which implements leading zero blanking, the oscillator pin also controls the blanking of the least significant digit; when the oscillator pin is open (backplane master) the least significant digit will not blank, and when the oscillator pin is grounded, the entire display will blank when the latch contents of all four digits are zero and the Leading Zero Blanking input is high. In order to cascade counters and have leading zero blanking operate correctly, the least-significant counter should be the backplane master, with the other counters as slaves.

An on-board oscillator and divider chain generate the backplane and segment timing. The oscillator typically runs at 11kHz resulting in a backplane frequency of 85Hz. The oscillator may be slowed by connecting a capacitor between the oscillator pin and either power supply, or the oscillator pin may be overdriven by an external signal. When overdriving the oscillator, ensure that the input waveform does not swing close to ground to avoid putting the device into backplane slave mode. See $V_{IH}(osc)$ and $V_{IL}(osc)$ specifications.

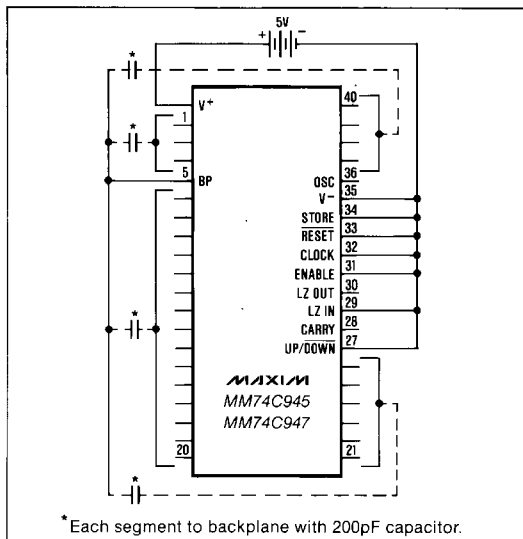

Figure 2. Test Circuit



Counter Circuitry Description

The MM74C945/7 are synchronous four-decade up/down counters. A high level on the UP/DOWN input causes the counter to count up, while a low level at this input causes the counter to count down. The counter indexes on the negative-going edge of the CLOCK input. The CARRY output will be high for one clock period when the counter is at 9999 in up mode or 0000 in down mode. On the Maxim devices, the CARRY output will not go high if the ENABLE input is low. This ensures that synchronous cascading does not allow the higher-order digits to count incorrectly as can occur with the original manufacturer's device when the low-order counter ENABLE input is low and the counter is at 9999 up or 0000 down. As shown in the applications figures, the CARRY output allows synchronous or ripple cascading.

The RESET and ENABLE inputs are provided to allow these counters to perform frequency and period measurements. The counter is forced to 0000 when RESET is taken low, and the counter (including the CARRY output) is disabled when the ENABLE input is taken low.

The counter outputs are latched. The latches are transparent and the display will follow the counter when the STORE input is low. The latches store the counter outputs when the STORE input is taken high.

On the MM74C945 the SELECT input allows the counter or latch to be selected for display. When the SELECT input is high, the counter contents are displayed, and when low, the latch contents are displayed. The BLANKING input on the MM74C945 blanks the entire display when taken high. The MM74C945 does not implement leading zero blanking.

On the MM74C947 the latch contents are always displayed, but the decoders include leading zero blanking circuitry and two pins to allow cascaded counters to leading zero blank properly. When the LZB IN pin is low, leading zero blanking is inhibited. When the LZB IN is high, the device will blank leading zeros except for the least-significant digit when the oscillator pin is open (backplane master). When the oscillator pin is grounded (backplane slave) the device will blank all digits when in 0000, and the LZB OUT will go high.

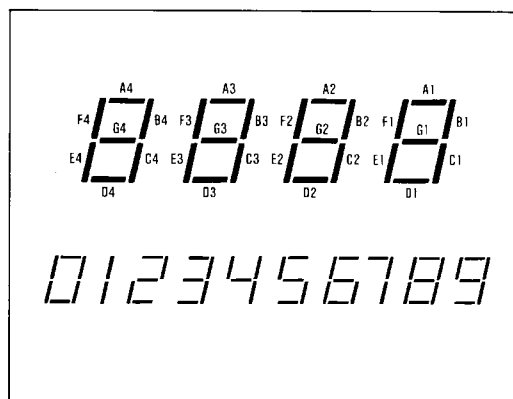
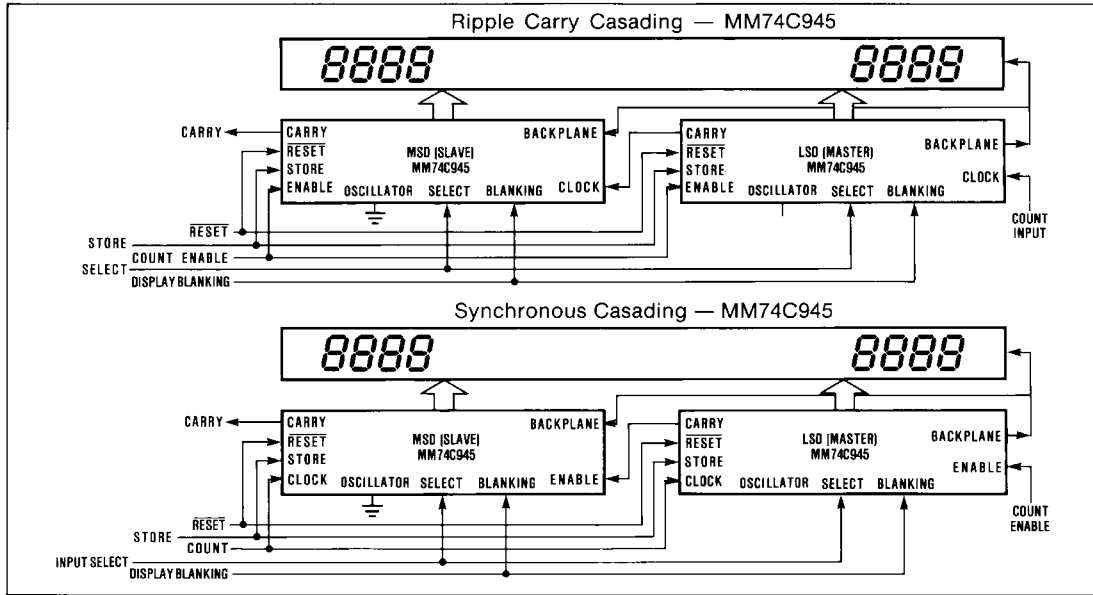

Figure 5. Segment Assignment and Display Font

4 Digit Up/Down Counter/Decoder/Driver

Typical Applications



Pin Configuration

Chip Topography

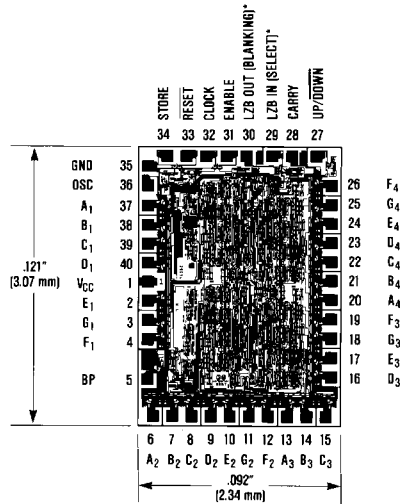
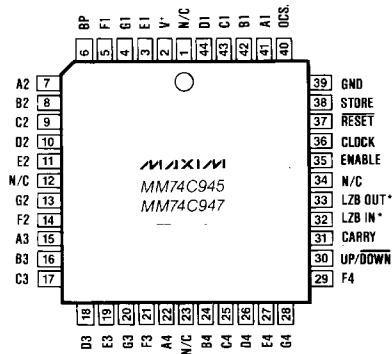

*Note:

PIN #	MM74C945 FUNCTION	MM74C947 FUNCTION
32	Select	LZB IN
33	Blanking	LZB OUT

*Note:

PIN #	MM74C945 FUNCTION	MM74C947 FUNCTION
29	Select	LZB IN
30	Blanking	LZB OUT

4 Digit Up/Down Counter/Decoder/Driver

Package Information

MM74C945/947

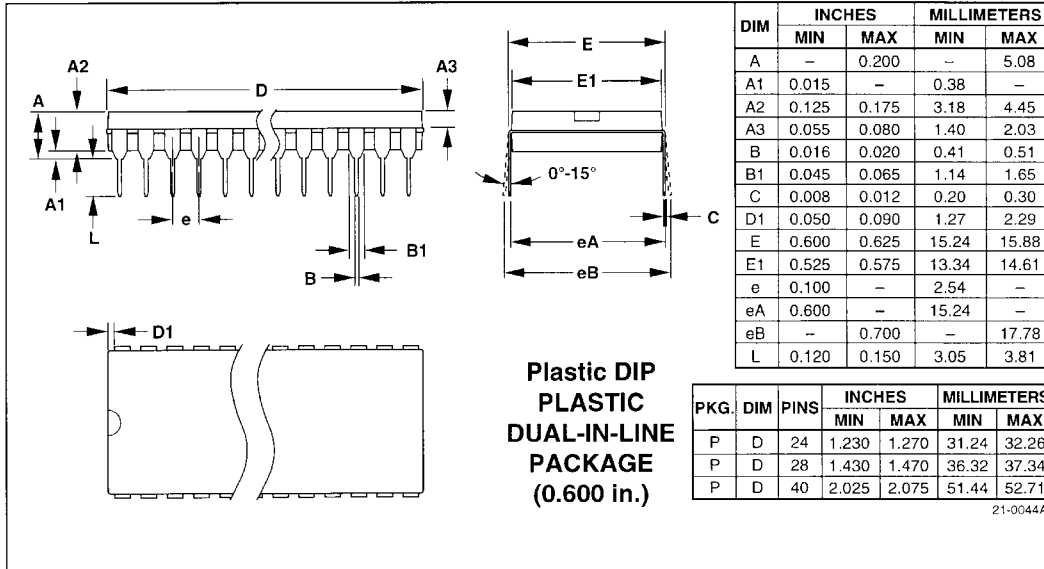

4 Digit Up/Down Counter/Decoder/Driver

Package Information

MM74C945/947

