

Acer

Aspire 5110/5100/3100
TravelMate 5510/5210
Extensa 5410/ 5010
Service Guide

Service guide files and updates are available on the ACER/CSD web. For more information, please refer to <http://csd.acer.com.tw>

Revision History

Please refer to the table below for the updates of Aspire 5110/5100/3100 and TravelMate 5510/5210 and Extensa 5410/5010 service guide.

Date	Chapter	Updates
April 26, 2007		New model name added

Copyright

Copyright© 2006 by Acer Incorporated. All rights reserved. No part of this publication may be reproduced, transmitted, transcribed, stored in a retrieval system, or translated into any language or computer language, in any form or by any means, electronic, mechanical, magnetic, optical, chemical, manual or otherwise, without the prior written permission of Acer Incorporated.

Disclaimer

The information in this guide is subject to change without notice.

Acer Incorporated makes no representations or warranties, either expressed or implied, with respect to the contents hereof and specifically disclaims any warranties of merchantability or fitness for any particular purpose. Any Acer Incorporated software described in this manual is sold or licensed "as is". Should the programs prove defective following their purchase, the buyer (and not Acer Incorporated, its distributor, or its dealer) assumes the entire cost of all necessary servicing, repair, and any incidental or consequential damages resulting from any defect in the software.

Acer is a registered trademark of Acer Incorporated.

AMD is a registered trademark of AMD Corporation.

Turion and Athlon are trademarks of AMD Corporation.

Other brand and product names are trademarks and/or registered trademarks of their respective holders.

Conventions

The following conventions are used in this manual:

SCREEN MESSAGES	Denotes actual messages that appear on screen.
NOTE	Gives bits and pieces of additional information related to the current topic.
WARNING	Alerts you to any damage that might result from doing or not doing specific actions.
CAUTION	Gives precautionary measures to avoid possible hardware or software problems.
IMPORTANT	Reminds you to do specific actions relevant to the accomplishment of procedures.

Preface

Before using this information and the product it supports, please read the following general information.

1. This Service Guide provides you with all technical information relating to the BASIC CONFIGURATION decided for Acer's "global" product offering. To better fit local market requirements and enhance product competitiveness, your regional office MAY have decided to extend the functionality of a machine (e.g. add-on card, modem, or extra memory capability). These LOCALIZED FEATURES will NOT be covered in this generic service guide. In such cases, please contact your regional offices or the responsible personnel/channel to provide you with further technical details.
2. Please note WHEN ORDERING FRU PARTS, you should check the most up-to-date information available on your regional web or channel. For whatever reason, if a part number change is made, it will not be noted in the printed Service Guide. For ACER-AUTHORIZED SERVICE PROVIDERS, your Acer office may have a DIFFERENT part number code to those given in the FRU list of this printed Service Guide. You MUST use the list provided by your regional Acer office to order FRU parts for repair and service of customer machines.

Table of Contents

Chapter 1 System Specification 1

Features	1
Platform	1
System Memory	1
Display	1
Graphics	1
TV-Tuner	1
Audio	2
Storage Subsystem	2
Communication	2
Special Keys and Controls	2
I/O Interface	3
Power Subsystem	3
Dimensions and Weight	3
Environment	4
Block Diagram	5
Outlook Tour	6
Front View	6
Closed Front View	7
Left View	8
Right View	8
Rear View	9
Base View	10
Using the Keyboard	11
Lock keys and Embedded Numeric Keypad	11
Windows keys	12
Hotkeys	12
Special keys	13
Indicators	14
Easy-launch Buttons	15
Touchpad	16
Touchpad Basics	16
Acer Empowering Technology	18
Empowering Technology Password	18
Acer eDataSecurity Management (for selected models)	18
Acer eLock Management	20
Acer ePerformance Management	21
Acer eRecovery Management	22
Acer eSettings Management	23
Acer ePower Management	24
Acer ePresentation Management	26
Using the System Utilities	27
Acer GridVista (dual-display compatible)	27
Launch Manager	28

Norton AntiVirus	29
How do I check for viruses?	29
Hardware Specification and Configuration	30
BIOS Setup Utility	41
Invoking BIOS Setup	41

Chapter 2 System Utilities 41

Information	42
Main	43
Advanced	45
Security	46
Boot	48
Exit	49
DOS Flash SOP	50

Chapter 3 Machine Disassembly and Replacement 53

General Information	54
Before You Begin	54
Disassembly Procedure Flowchart	55
Disassembly Procedure	57
Removing the Battery Pack	57
Removing the HDD Module	57
Removing the RAM Module/Mini PCI Card/Thermal Module/CPU	58
Removing the ODD Module	60
Removing the LCD Module from the Main Unit	61
Removing the Keyboard	62
Disassembling the Main Unit	63
Disassembling the LCD Module	68

Chapter 4 Troubleshooting 71

System Check Procedures	72
External Diskette Drive Check	72
External CD-ROM Drive Check	72
Keyboard or Auxiliary Input Device Check	72
Memory Check	73
Power System Check	73
Check the Power Adaptor	73
Check the Battery Pack	74
Touchpad Check	74
Power-On Self-Test (POST) Error Message	76
Index of Error Messages	76
POST Code	79
Index of Symptom-to-FRU Error Message	80

Intermittent Problems	84
Undetermined Problems	85

Chapter 5 Jumper and Connector Location 86

Main Board	86
Top Side	86
Bottom Side	88
Switch Board	90
Top Side	90
Bottom Side	91

Chapter 6 FRU (Field Replacement Unit) List 92

Parts	93
Exploded Diagram	102

System Specification

Features

NOTE: This product line has both UMA and Discrete SKU. The Discrete SKU has thermal module and the UMA SKU has no thermal module.

Platform

- AMD Turion™ 64 X2 dual-core TL-50/TL-52/TL-56/TL-60/TL-62 processor or higher with 1MB L2 cache, supporting AMD PowerNow!™ Technology and AMD HyperTransport™ Technology
- Mobile AMD Sempron™ 3200+/3400+/3500+ or higher with 512KB L2 cache, supporting AMD PowerNow!™ Technology and AMD HyperTransport™ Technology, 64bit OS compatible
- ATI Radeon® Xpress 1100 or Xpress 1200 chipset

System Memory

- Up to 2GB of DDR2 533/667MHz memory, upgradeable to 4GB using two soDIMM modules (dual-channel support)

Display

- 15.4" WXGA Acer CrystalBrite™ TFT LCD, 1280 x 800 pixel resolution, 16 ms response time, supporting simultaneous multi-window viewing on dual displays via Acer GridVista™
- 15" XGA colour TFT LCD, 1024 x 768 pixel resolution

Graphics

- ATI Radeon® Xpress 1100 chipset with integrated 3D graphics, up to 256MB of shared system memory
- ATI Mobility™ Radeon® X1300/X1600 with up to 512MB of HyperMemory™ (64MB of dedicated GDDR2 VRAM; up to 448MB of shared system memory), supporting ATI PowerPlay™ 5.0, Microsoft® DirectX® 9.0, PCI Express®, DualView™ support
- 16.7 million colours
- MPEG-2/DVD hardware-assisted capability
- S-video/TV-out (NTSC/PAL) support (**for selected models**)
- Acer Arcade™, featuring Acer CinemaVision™ and Acer ClearVision™ technology

TV-Tuner

- Acer TV-tuner options (**for selected models**):
 - Analog TV-tuner supporting hardware MPEG-2 stream encoding
 - Digital and analog hybrid TV-tuner supporting hardware MPEG-2 stream encoding
 - Digital and analog hybrid TV-tuner supporting software MPEG-2 stream encoding
- Analog TV-tuner supporting international analog TV standards (NTSC/PAL/SECAM)

-
- Digital TV-tuner supporting DVB-T (Digital Video Broadcasting Terrestrial) standard (6MHz to 8MHz) TV-tuner I/O:
 - RF jack for digital/analog TV antenna cable input
 - AV-in port for composite/S-video/line-in audio/video input
 - TV-tuner cables:
 - NTSC/PAL cable for digital/analog TV input, NTSC converter to convert port from PAL/SECAM to NTSC
 - Mini DIN cable: RCA jack and S-video port for audio/video input
 - Acer DVB-T antenna (UHF/VHF reception) supports Acer SignalUp™ wireless technology

Audio

- High Definition audio support
- S/PDIF (Sony/Philips Digital Interface) support for digital speakers **(for selected models)**
- Audio system with two built-in speakers
- Sound Blaster Pro™ and MS Sound compatible
- Built-in microphone

Storage Subsystem

- 40/60/80/100/120GB or higher ATA/100 hard disk drive
- Optical drive options:
 - DVD-Super Multi double-layer drive
 - DVD/CD-RW combo drive
- 5-in-1 card reader, supporting Secure Digital (SD), MultiMediaCard (MMC), Memory Stick® (MS), Memory Stick PRO™ (MS PRO), xD-Picture Card™ (xD) **(for selected models)**

Communication

- Acer Video Conference featuring Voice and Video over Internet Protocol (VVoIP) support via Acer OrbiCam™ and optional Acer Bluetooth® VoIP phone **(for selected models)**
- Acer OrbiCam™ integrated 310,000 pixel CMOS camera **(for selected model)** featuring:
 - 225 degree ergonomic rotation
 - Acer PrimaLite™ technology
- Modem: 56K ITU V.92 with PTT approval; Wake-on-Ring ready
- LAN: gigabit or Fast Ethernet; Wake-on-LAN ready
- WPAN: Bluetooth® 2.0 + EDR (Enhanced Data Rate)
- WLAN: Acer InviLink™ 802.11b/g or 802.11a/b/g Wi-Fi CERTIFIED™ solution, supporting Acer SignalUp™ wireless technology

Special Keys and Controls

- 88/89-key keyboard, with inverted “T” cursor layout; 2.5 mm (minimum) key travel, international language support
- Touch pad with 4-way scroll button
- 12 function keys, four cursor keys, two Windows® keys, hotkey controls, embedded numeric keypad

-
- Four easy-launch buttons: Empowering Key, email, Internet and user-programmable button
 - Six/Seven media keys: TV, volume up, volume down, play/pause, stop, previous, next (**for selected models**)
 - Two communication switches: WLAN, Bluetooth®
 - Acer remote controls (**for selected models**):
 - Acer Arcade™ (48 keys)
 - Windows® Media Center Edition (Uses an external USB CIR receiver)

I/O Interface

- ExpressCard™ /34 slot (**for selected models**)
- PC Card slot (one Type II)
- 5-in-1 card reader (SD/MMC/MS/MS PRO/xD) (**for selected models**)
- Four USB 2.0 ports (**three for selected models**)
- DVI-D port (**for selected models**)
- IEEE 1394 port (**for selected models**)
- Consumer infrared (CIR) port (**for selected models**)
- External display (VGA) port
- AV-in port (**for selected models**)
- RF-in jack (**for selected models**)
- S-video/TV-out (NTSC/PAL) port (**for selected models**)
- Headphones/speaker/line-out jack with S/PDIF support (**for selected models**)
- Microphone-in jack
- Line-in jack
- Ethernet (RJ-45) port
- Modem (RJ-11) port
- DC-in jack for AC adapter

Power Subsystem

- ACPI 2.0 CPU power management standards: Stand-by and Hibernation power-saving modes support
- 71W 4800mAh (8-cell) Li-ion battery pack
- 44W 4000mAh (6-cell) Li-Ion battery
- 29.6W 2000mAh (4-cell) Li-ion battery
- Acer QuicCharge™ technology: 80% charge in 1 hour; 2-hour rapid charge system-off; 2.5-hour charge-in-use

NOTE: Only support for SKU with 90W adapter.

- 3-pin 65/90W AC adapter

Dimensions and Weight

Aspire 5110

- 358 (W) x 269 (D) x 29.8/33.8 (H) mm (14.1 x 10.6 x 1.17/1.33 inches)
- 3.0 kg (6.61 lbs.) for 15.4" LCD model with TV module
- 2.92 kg (6.44 lbs.) for 15.4" LCD model without TV module

Aspire 5100/3100 Series

- 358 (W) x 269 (D) x 29.8/33.8 (H) mm (14.1 x 10.6 x 1.17/1.33 inches)
- 2.82 kg (6.22 lbs.) for 15.4" LCD model
- 2.78 kg (6.13 lbs.) for 15" LCD model

Environment

- Temperature:
 - Operating: 5 °C to 35 °C
 - Non-operating: -20 °C to 65 °C
- Humidity (non-condensing):
 - Operating: 20% to 80%
 - Non-operating: 20% to 80%

Block Diagram

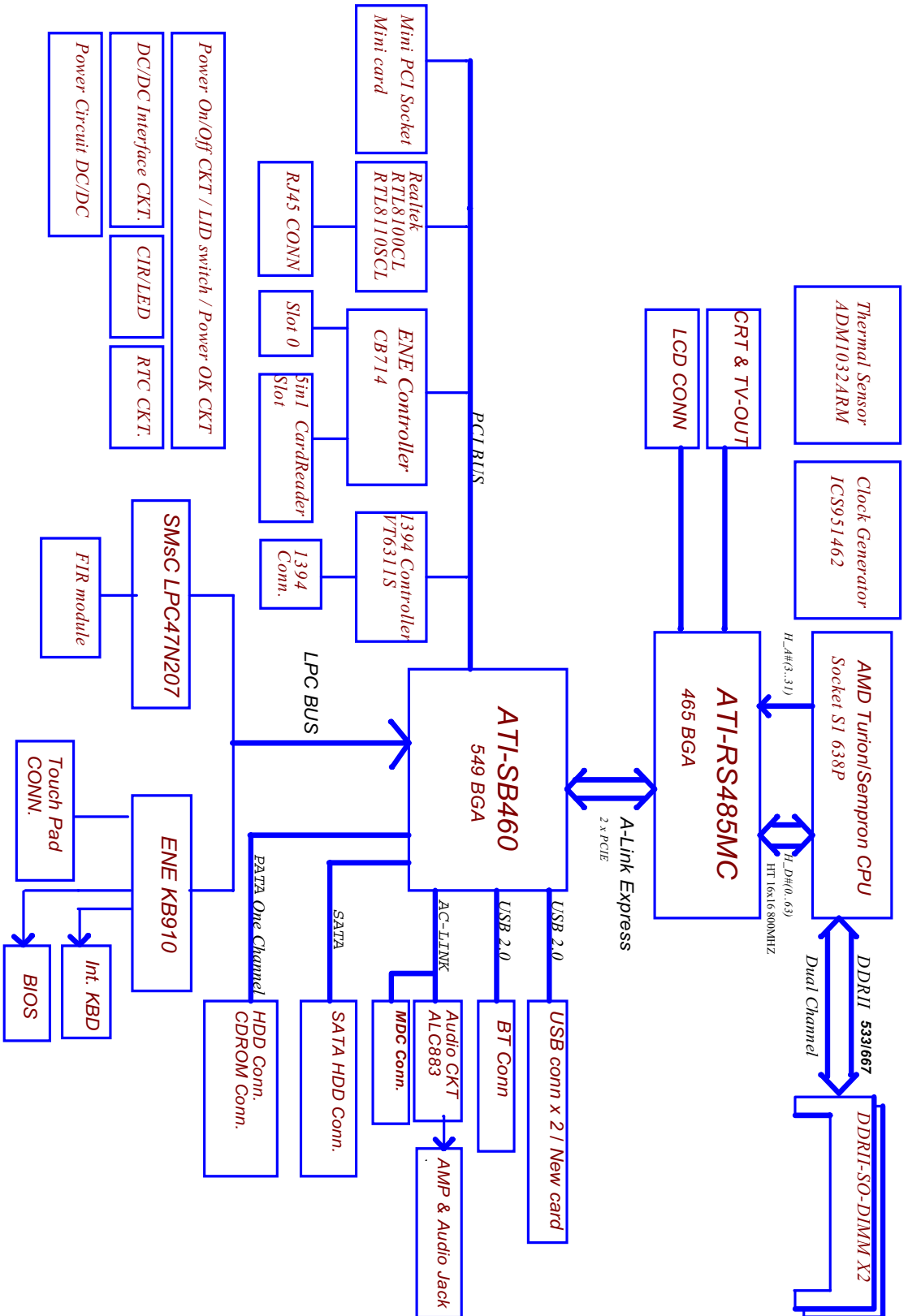

Outlook Tour



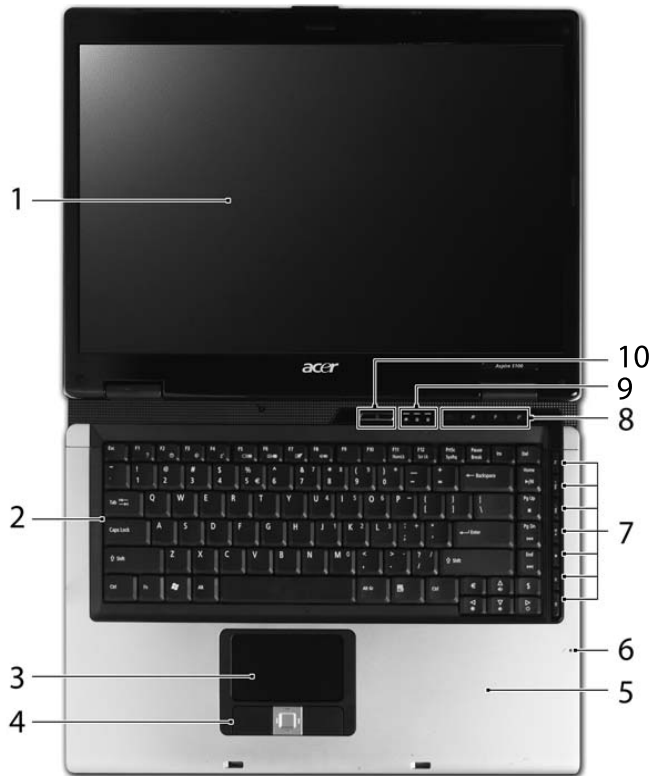



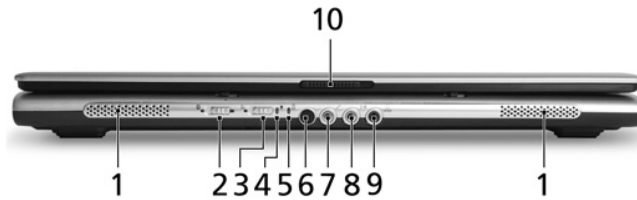

Front View



#	Item	Description
1	Display screen	Also called Liquid-Crystal Display (LCD), displays computer output.
2	Keyboard	Serves for entering data into your computer.
3	Touchpad	Touch-sensitive pointing device which functions like a computer mouse
4	Click buttons (left, center and right)	The left and right buttons function like the left and right mouse buttons; the center button serves as a four-way scroll button.
5	Palmrest	Comfortable support area for your hands when you use the computer.
6	Microphone	Internal microphone for sound recording.
7	TV/media/volume buttons	For use with Acer Arcade and other media playing programs (for selected models).
8	Easy-launch buttons	Buttons for launching frequently used programs.
9	Status indicators	Light-Emitting Diodes (LEDs) that light up to show the status of the computer's functions and components.
10	Power button	Turns the computer on and off.

Closed Front View



#	Icon	Item	Description
1	N/A	Speakers	Left and right speakers deliver stereo audio output.
2		Bluetooth communication button/indicator	Enables/disables the Bluetooth communication. Indicates the status of Bluetooth communication (for selected models).
3		Wireless communication button/indicator	Enables/disables the wireless function. Indicates the status of wireless LAN communication.
4		Power indicator	Indicates the computer's power status.
5		Battery indicator	Indicates the computer's battery status.
6		CIR receiver	Receives signals from a remote control (for selected models).
7		Microphone-in jack	Accepts input from external microphones.
8		Line-in jack	Accepts audio line-in devices (e.g., audio CD player, stereo walkman).
9		Headphones/speaker/line-out jack with S/PDIF support	Connects to audio line-out devices (e.g., speakers, headphones).
10	N/A	Latch	Locks and releases the lid.

Left View



#	Icon	Item	Description
1		Kensington lock slot	Connects to a Kensington-compatible computers security lock.
2	N/A	Ventilation slots	Enable the computer to stay cool, even after prolonged use.
3		Three USB 2.0 ports	Connect to USB 2.0 devices (e.g., USB mouse, USB camera).
4		Ethernet (RJ-45) port	Connects to an Ethernet 10/100-based or 10/100/1000-based networks.
5		Infrared port	Interfaces with infrared devices (e.g., infrared printer and IR-aware computer) (optional) .
6		5-in-1 card reader	Accepts Memory Stick (MS), Memory Stick Pro (MS PRO), MultiMediaCard (MMC), Secure Digital (SD) and xD-Picture Card (xD) (optional) .
7		4-pin IEEE 1394 port	Connects to IEEE 1394 devices (optional) .
8		PC Card slot	Accepts one Type II PC Card.
9	ExpressCard/34	ExpressCard/34 slot	Accepts one ExpressCard/34 module (optional) .
10	N/A	PC Card slot eject button	Ejects the PC Card from the slot.







Right View



#	Item	Description
1	Optical disk drive	Internal optical drive; accepts CDs or DVDs.
2	Optical disk access indicator	Lights up when the optical disk drive is active.
3	Optical disk drive eject button	Ejects the drive tray from the drive.
4	Emergency eject hole	Ejects the drive tray when the computer is turned off.

Rear View



#	Icon	Item	Description
Aspire 5110 / 5100 / 3100 Series			
1		Modem (RJ-11) port	Connects to a phone line.
2		Two USB 2.0 ports	Connect to USB 2.0 devices (e.g., USB mouse, USB camera).
3	RF	RF-in jack	Accepts input signals from analog/digital TV-tuner devices (for selected models).
4	AV-IN	AV-in port	Accepts input signals from audio/video (AV) devices (for selected models).
5		Power jack	Connects to an AC adapter.
6		S-video port/TV out port (NTSC/PAL) port	Connects to a television or display device with S-video input (for selected models).
7		External display (VGA) port	Connects to an external display device (e.g., external monitor, LCD projector).
8	DVI-D	DVI-D port	Supports digital video connections (for selected models).
9		USB 2.0 port	Connect to USB 2.0 devices (e.g., USB mouse, USB camera).
10	N/A	Ventilation slots	Enable the computer to stay cool, even after prolonged use.

Base View

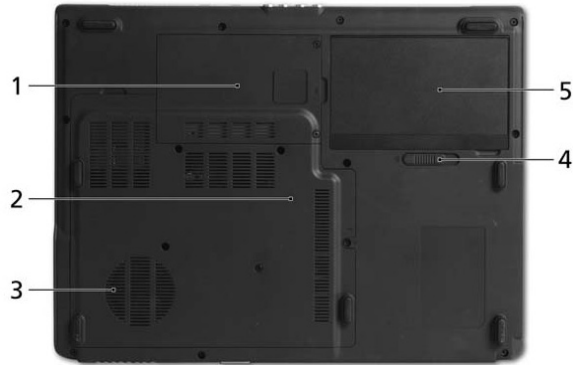

#	Item	Description
1	Hard disk bay	Houses the computer's hard disk (secured with screws).
2	Memory compartment	Houses the computer's main memory.
3	Ventilation slots and cooling fan	Helps keep the computer cool. NOTE: Do not cover or obstruct the opening of the fan.
4	Battery lock	Locks the battery in position.
5	Battery bay	Houses the computer's battery pack.

Using the Keyboard

The full-sized keyboard includes an embedded numeric keypad, separate cursor, lock, Windows, function and special keys.

Lock keys and Embedded Numeric Keypad

The keyboard has three lock keys which you can toggle on and off.











Lock Key	Description
Caps Lock	When Caps Lock is on, all alphabetic characters are typed in uppercase.
Num Lock <Fn> + <F11>	When Num Lock is on, the right hand side numeric keypad is in numeric mode. The keys function as a calculator (complete with the arithmetic operators +, -, *, and /). When Num Lock is off, the keys assume cursor and other shortcut functions.
Scroll Lock <Fn> + <F12>	When Scroll Lock is on, the screen moves one line up or down when you press the up or down arrow keys respectively. scroll Lock does not work with some applications.

The embedded numeric keypad functions like a desktop numeric keypad. It is indicated by small characters located on the upper right corner of the keycaps. To simplify the keyboard legend, cursor-control key symbols are not printed on the keys.

Desired access	Num Lock on	Num Lock off
Number keys on embedded keypad	Type numbers in a normal manner.	N/A
Cursor-control keys on embedded keypad	Hold <Shift> while using cursor-control keys.	Hold <Fn> while using cursor-control keys.
Main keyboard keys	Hold <Fn> while typing letters on embedded keypad.	Type the letters in a normal manner.

Windows keys





The keyboard has two keys that perform Windows-specific functions.









Key	Icon	Description
Windows key		<p>Press alone. This key has the same effect as clicking on the Windows Start button. It launches the Start menu. It can also be used with other keys to provide a variety of functions:</p> <ul style="list-style-type: none">  + <Tab>: Activates the next Taskbar button.  + <E>: Opens the My Computer window.  + <F1>: Opens Help and Support.  + <F>: Opens the Find (All Files dialog box).  + <R>: Opens the Run dialog box.  + <M>: Minimizes all windows. <p><Shift> +  + <M>: Undoes the minimize all windows action.</p>
Application key		This key has the same effect as clicking the right mouse button. It opens the application's context menu.

Hotkeys

The computer employs hotkeys or key combinations to access most of the computer's controls like screen brightness, volume output and the BIOS utility. To activate hotkeys, press and hold the <Fn> key before pressing the other key in the hotkey combination.



Hot Key	Icon	Function	Description
<Fn> + <F1>		Hot key help	Displays help on hotkeys.
<Fn> + <F2>		Acer eSettings	Launches the Acer eSettings in Acer Empowering Technology.
<Fn> + <F3>		Acer ePower Management	Launches the Acer ePower Management in Acer Empowering Technology.
<Fn> + <F4>		Sleep	Leads the computer to Sleep mode.

Hot Key	Icon	Function	Description
<Fn> + <F5>		Display toggle	Switches the display output between the display screen, external monitor (if connected) and both.
<Fn> + <F6>		Screen blank	Turns off the display screen backlight to save power. Press any key to return.
<Fn> + <F7>		Touchpad toggle	Turns the internal touchpad on and off.
<Fn> + <F8>		Speaker toggle	Turns the speakers on and off.
<Fn> + <↑>		Volume up	Increases the sound volume.
<Fn> + <↓>		Volume down	Decreases the sound volume.
<Fn> + <→>		Brightness up	Increases the screen brightness.
<Fn> + <←>		Brightness down	Decreases the screen brightness.

Special keys

You can locate the Euro symbol and the US dollar sign on the upper-center and/or bottom-right side of the keyboard.



The Euro Symbol

1. Open a text editor or word processor.
2. Either directly press the <Euro> key on the bottom-right side of the keyboard, or hold <Alt Gr> key then press the number <5> key on the upper-center side of the keyboard.

NOTE: Some fonts and software do not support the Euro symbol. Please refer to www.microsoft.com/typography/faq/faq12.htm for more information.

The US Dollar Sign







1. Open a text editor or word processor.
2. Either directly press the <\$> key on the bottom-right side of the keyboard, or hold <Shift> and then press the US dollar sign on the number <4> key.

NOTE: This function varies according to the language settings.

Indicators

The computer has several easy-to-read status indicators. The front panel indicators are visible even when the computer cover is closed up.



Icon	Item	Description
	HDD	Indicates when the hard disk drive is active.
	Caps Lock	Lights up when Caps Lock is activated.
	Num Lock	Lights up when Num Lock is activated.
	Power	Lights when the computer is on.
	Battery	Lights when the battery is being charged.
	Bluetooth	Indicates the status of Bluetooth communication
	Wireless LAN	Indicates the status of wireless LAN communication

Easy-launch Buttons

There are several conveniently located easy-launch buttons. They are one user-programmable button, web browser button, mail button, and Acer Empowering Key *e*. Press *e* to run the Acer Empowering Technology. Although the mail and web browser buttons are pre-set to E-mail and Internet programs, they can be redefined by users. To set the web browser, mail and programmable buttons, run the Acer Launch Manager.



Easy-launch button	Default application
<i>e</i>	Acer Empowering Technology (user-programmable)
Mail	E-mail application (user-programmable)
Web browser	Internet browser (user-programmable)
P	User-programmable

Touchpad

The built-in touchpad is a pointing device that senses movement on its surface. This means the cursor responds as you move your finger across the surface of the touchpad. The central location on the palmrest provides optimum comfort and support.

Touchpad Basics

Use the touchpad as follows:

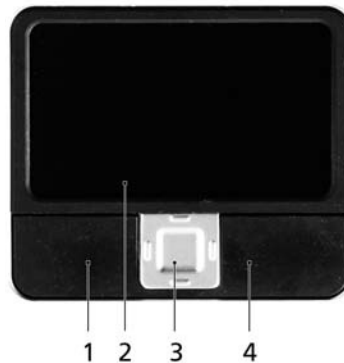

- Move your finger across the touchpad (2) to move the cursor.
- Press the left (1) and right (4) buttons located on the edge of the touchpad to perform selection and execution functions. These two buttons are similar to the left and right buttons on a mouse. Tapping on the touchpad (2) is the same as clicking the left button.
- Use the four-way scroll (3) button to scroll up or down and move left or right a page. This button mimics your cursor pressing on the right scroll bar of windows applications.

Function	Left button (1)	Right button (4)	Main touchpad (2)	Center button (3)
Execute	Quickly click twice.		Tap twice (at the same speed as double-clicking a mouse button).	
Select	Click once		Tap once	
Drag	Click and hold. Then slide your finger across the touchpad to drag the cursor over the selection.		Tap twice (at the same speed as double-clicking a mouse button); rest your finger on the touchpad on the second tap and drag the cursor.	
Access context menu		Click once		
Scroll				Click and hold to move up/down/left/right.

NOTE: Keep your fingers, as well as the surface of the touchpad dry and clean. The touchpad is sensitive to your finger movements: the lighter the touch, the better the response. Tapping hard will not increase

the touchpad's responsiveness.

NOTE: By default, vertical and horizontal scrolling is enabled on your touchpad. It can be disabled under Mouse settings in Windows Control Panel.

Acer Empowering Technology

Acer's innovative Empowering Technology toolbar makes it easy to have access to the frequently used functions and manage the notebook. Displayed by default in the upper-right corner of the screen, it features the following handy utilities:

- **Acer eDataSecurity Management** protects data with passwords and advanced encryption algorithms (for selected models).
- **Acer eLock Management** limits access to external storage media.
- **Acer ePerformance Management** improves system performance by optimizing disk space, memory and registry setting.
- **Acer eRecovery Management** backs up and recovers data flexibly, reliably and completely.
- **Acer eSettings Management** accesses system information and adjusts settings easily.
- **Acer ePower Management** extends battery power via versatile usage profiles.
- **Acer ePresentation Management** connects to a projector and adjusts display settings conveniently.



For more information, right click on the Empowering Technology toolbar, then select the Help or Tutorial function.

Empowering Technology Password

Before using Acer eLock Management and Acer eRecovery Management, You must initialize the Empowering Technology password. Right click on the Empowering Technology toolbar and select **Password Setup** to do so. If you do not initialize the Empowering Technology password, you will be prompted to do so when running Acer eLock Management or Acer eRecovery Management for the first time.

NOTE: If you lose your password, there is no method to reset it except by reformatting your notebook or taking your notebook to an Acer Customer Service Center. Be sure to remember or write down your password.

Acer eDataSecurity Management (for selected models)

Acer eDataSecurity Management is a handy file encryption utility that protects the files from being accessed by unauthorized persons. It is conveniently integrated with Windows Explorer as a shell extension for quick and easy data encryption/decryption and also supports on-the-fly file encryption for MSN Messenger and Microsoft Outlook.

The Acer eDataSecurity Management setup wizard will prompt you for a supervisor password and default encryption. This encryption will be used to encrypt files by default, or you can choose to enter your own file-specific password when encrypting a file.

NOTE: The password used to encrypt a file is the unique key that the system needs to decrypt it. If you lose the password, the supervisor password is the only other key capable of decrypting the file. **If you lose both passwords, there will be no way to decrypt your encrypted file! Be sure to safeguard all related passwords!**

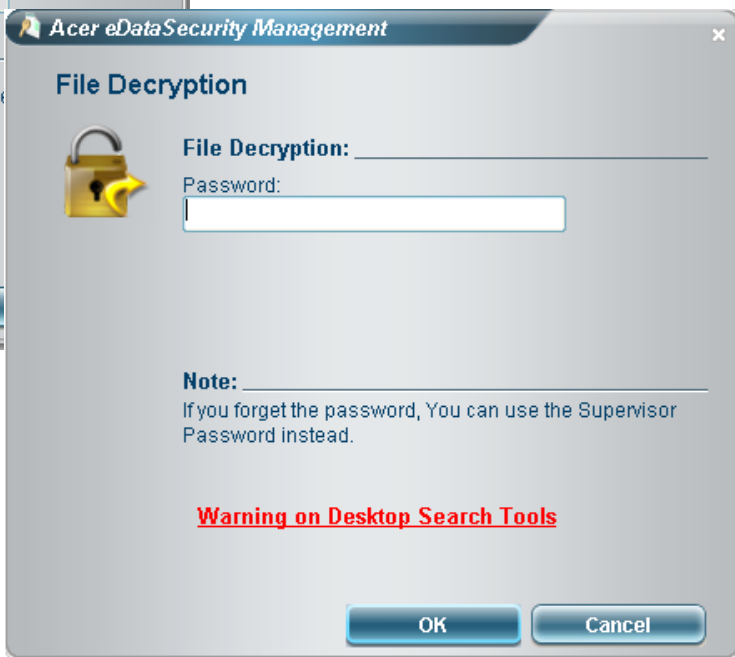

Acer eLock Management

Acer eLock Management is a security utility that allow you to lock up your removable data, optical and floppy drives to ensure that data can not be stolen while your notebook is unattended.

- Removable data devices: includes USB disk drives, USB pen drives, USB flash drives, USB MP3 drives, USB memory card readers, IEEE 1394 disk drives and any other removable disk drives that can be mounted as a file system when plugged into the system.
- Optical drive devices: includes any kind of CD-ROM or DVD-ROM drives.
- Floppy disk drives: 3.5-inch disks only.
- Interfaces: includes serial port, parallel port, infrared (IR), and Bluetooth.

To activate Acer eLock Management, a password must be set at first. Once set, you may apply locks to any of the three kinds of devices. Lock(s) will be set without any reboot necessary, and will remain locked after rebooting, until unlocked.

NOTE: If you lose the password, there is no method to reset it except by reformatting the notebook or taking the notebook to an Acer Customer Service Center. Be sure to remember or write down the password.

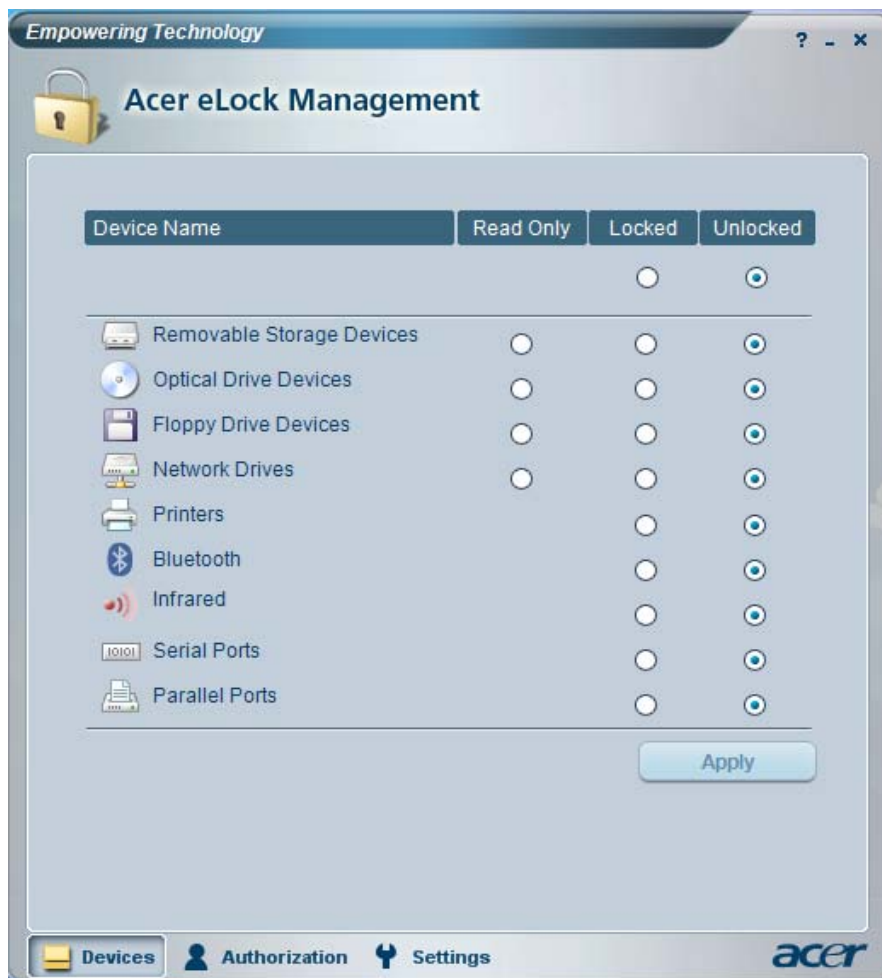

Acer ePerformance Management

Acer ePerformance Management is a system optimization tool that boosts the performance of the Acer notebook. It provides an express optimization method to release unused memory and disk space quickly. The user can also enable advanced options for full control over the following options:

- Disk optimization: removes unneeded items and files.
- Speed optimization: improves the usability and performance of the Windows XP system.
- Memory optimization: releases unused memory and check usage.

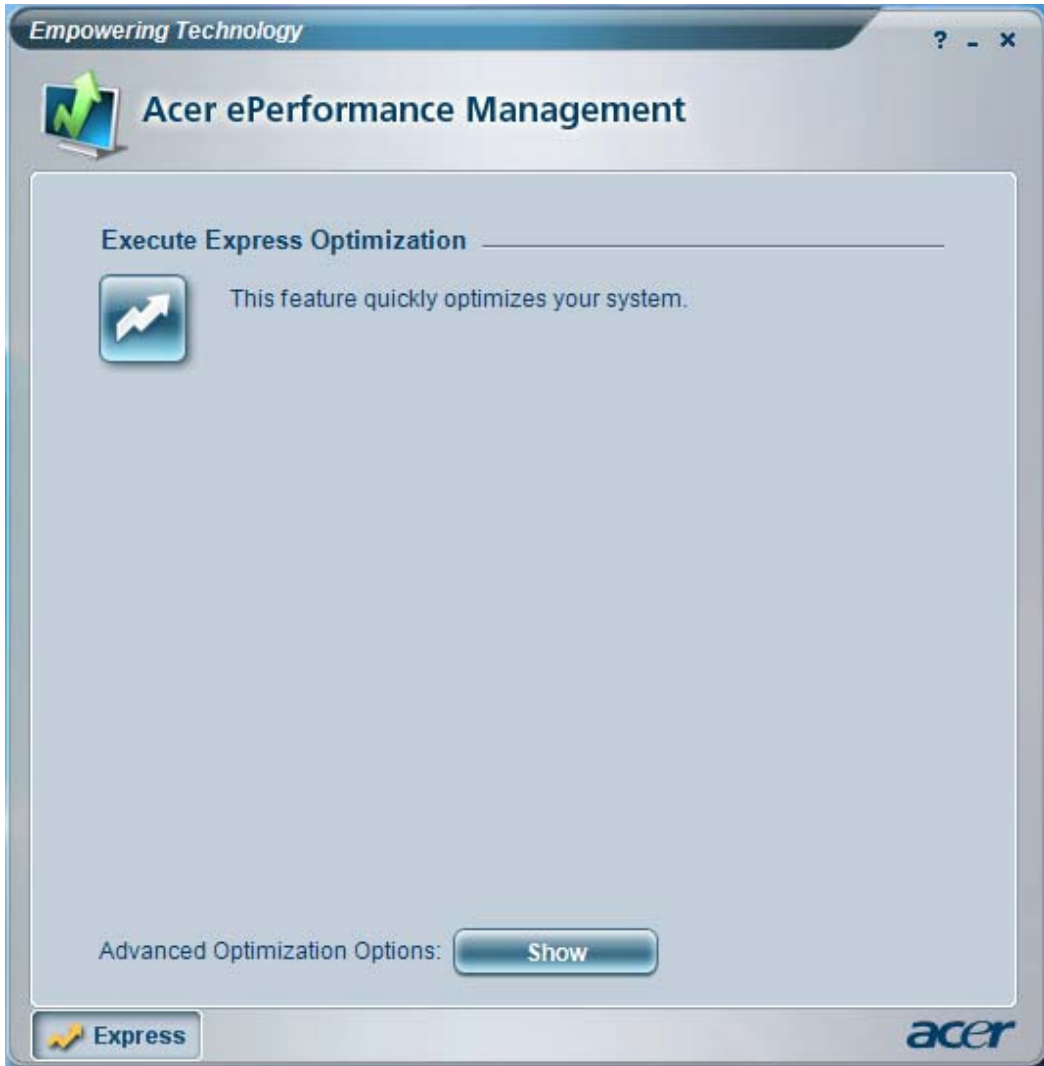

Acer eRecovery Management

Acer eRecovery Management is a powerful utility with the need for recovery disks provided by the manufacturer. The Acer eRecovery Management utility occupies space in a hidden partition on the system's HDD. By default, user-created backups are stored on D:\ drive. Acer eRecovery Management provides:

- Password protection
- Recovery of applications and drives
- Image or data backup:
 - Backup to HDD (set recovery point)
 - Backup to CD or DVD
- Image/data recovery tools:
 - Recovery from a hidden partition (factory defaults)
 - Recovery from the HDD (most recent user-defined recovery point)
 - Recovery from CD or DVD

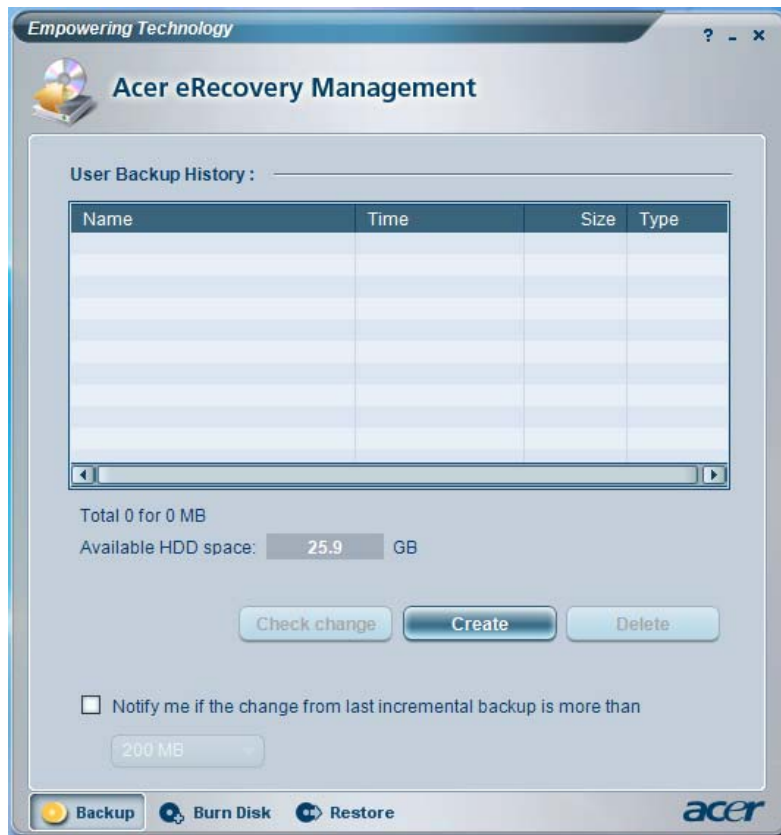

NOTE: If the computer did not come with a Recovery CD or System CD, please use Acer eRecovery Management's "System backup to optical disk" feature to burn a backup image to CD or DVD. To ensure the best results when recovering the system using a CD or Acer eRecovery Management, detach all peripherals (except external Acer ODD, if equipped), including the Acer ezDock.

Acer eSettings Management

Acer eSettings Management allows you to inspect hardware specification, change BIOS passwords or other Windows settings, and to monitor the system health status.

Acer eSettings Management also:

- Provides a simple graphical user interface for navigation.
- Displays general system status and advanced monitoring for power users on Acer computer.



Acer ePower Management

Acer ePower Management features a straightforward user interface. To launch it, select Acer ePower Management from the Empowering Technology interface.

AC Mode (Adapter Mode)

The default setting is “Maximum Performance.” You can adjust CPU speed, LCD brightness and other settings, or click on buttons to turn the following functions on/off: wireless LAN, Bluetooth, CardBus, fireware (1394), wired LAN and optical device if supported.

DC Mode (Battery Mode)

There are four pre-defined profiles: Entertainment, Presentation, Word Processing, and Battery Life. You can also define up to three of your own.

To Create a New Power Profile

1. Change power settings as desired.
2. Click **Save as...** to save to a new power profile.
3. Name the newly created profile.
4. Select whether this profile is for Adapter or Battery mode, then click **OK**.
5. The new profile will appear in the profile list.

Battery Status

For real-time battery life estimates based on current usage, refer to the panel on the upper half side of the window.



For additional options, click **Settings** to:

- Set alarms.

- Reload factory defaults.
- Select what actions to be taken when the cover is closed or the power button is pressed.
- Set passwords for accessing the system after Hibernation or Stand-by.
- View information about Acer ePower Management.

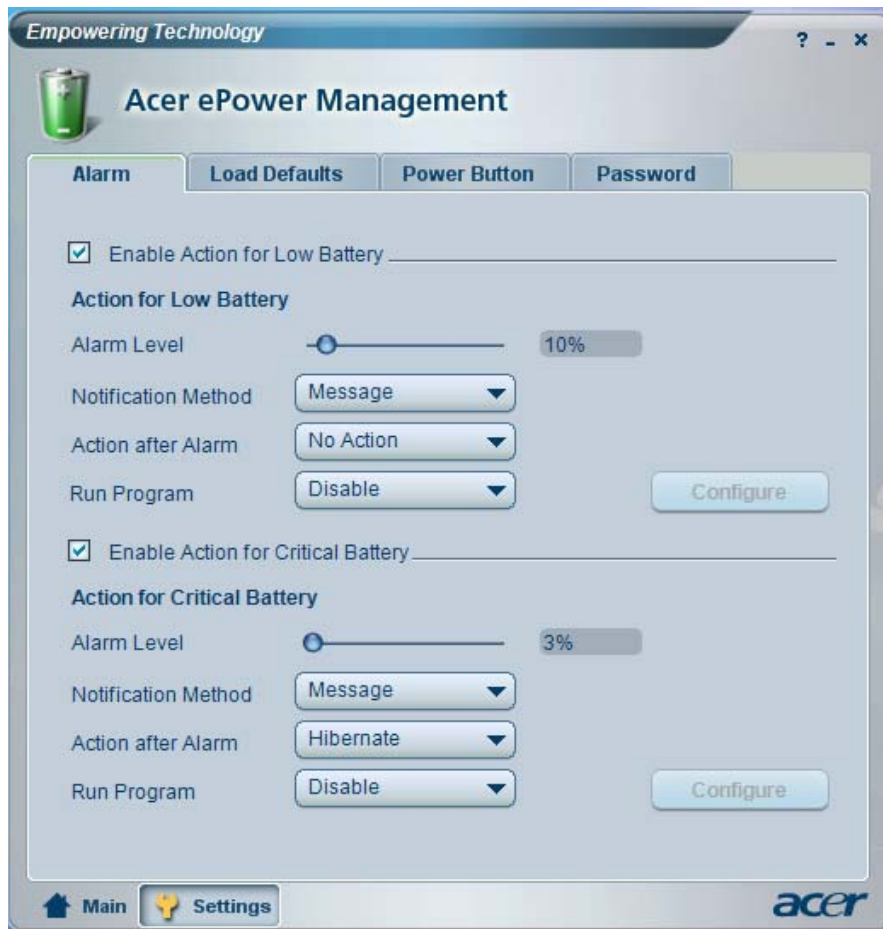

Acer ePresentation Management

Acer ePresentation Management lets you project your computer's display to an external device or projector using the hotkey: **<Fn> + <F5>**. If auto-detection hardware is implemented in the system and the external display supports it, your system display will be automatically switched out when an external display is connected to the system. For projectors and external devices that are not auto-detected, launch Acer ePresentation Management to choose an appropriate display setting.

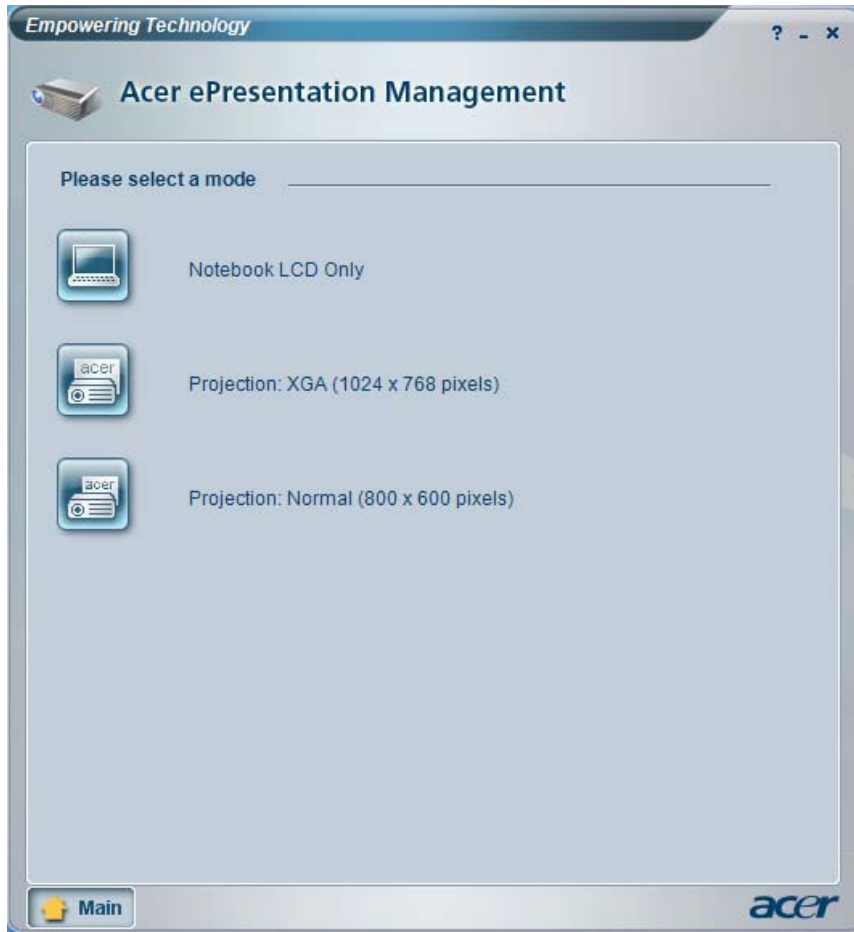

NOTE: If the restored resolution is not correct after disconnecting a projector, or you need to use an external resolution that is not supported by Acer ePresentation Management, adjust your display settings using Display Properties or the utility provided by the graphics vendor.

Using the System Utilities

NOTE: The system utilities work under Microsoft Windows XP only.

Acer GridVista (dual-display compatible)

NOTE: This feature is only available on certain models.

To enable the dual monitor feature of the notebook, first ensure that the second monitor is connected, then select Start, Control Panel, Display and click on Settings. Select the secondary monitor (**2**) icon in the display box and then click the check box Extend my windows desktop onto this monitor. Finally, click Apply to confirm the new settings and click OK to complete the process.

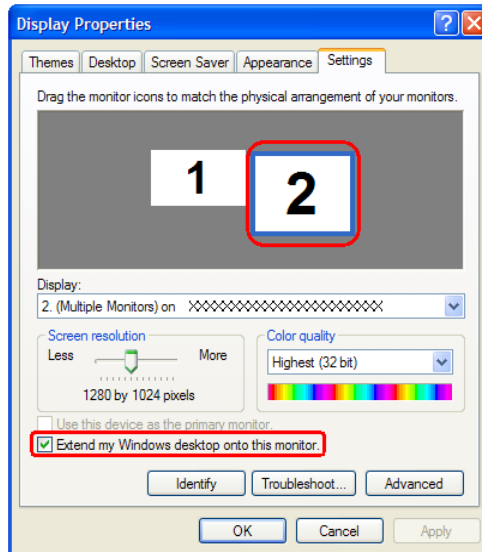

Acer GridVista is a handy utility that offers four pre-defined display settings so you can view multiple windows on the same screen. To access this function, please go to Start > All Programs and click on Acer GridVista. You may choose any one of the four display settings indicated below:



Acer GridVista is dual-display compatible, allowing two displays to be partitioned independently. Acer GridVista is simple to set up:

1. Run Acer GridVista and select your preferred screen configuration for each display from the task bar.
2. Drag and drop each window into the appropriate grid.
3. Enjoy the convenience of a well-organized desktop.

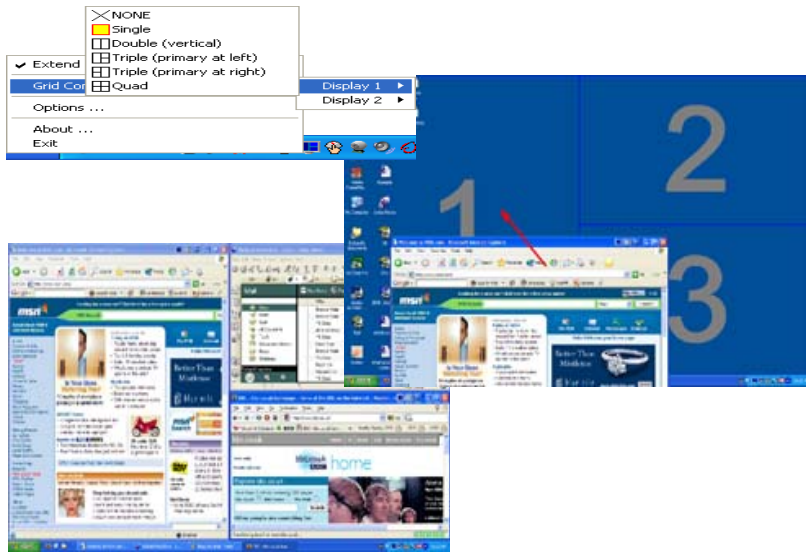

NOTE: Please ensure that the resolution setting of the second monitor is set to the manufacturer's recommended value.

Launch Manager

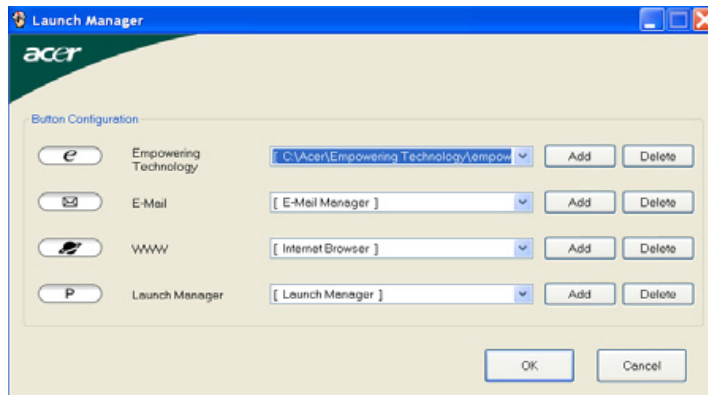

Launch Manager allows you to set the four easy-launch buttons located above the keyboard. You can access the Launch Manager by clicking on Start > All Programs > Launch Manager to start the application.

Norton AntiVirus

Norton AntiVirus is an anti-virus software that finds and repairs infected files, and protects against viruses to keep you computer data safe and secure.

How do I check for viruses?

A Full System Scan scans all files on your computer. To perform a system scan:

1. Start Norton Antivirus: Double click on the **Norton AntiVirus** Icon on the desktop or click on the **Start** menu in the Windows task bar, highlight **Programs**, and select **Norton Antivirus**.
2. In the Norton Antivirus main window, click **Scans**.

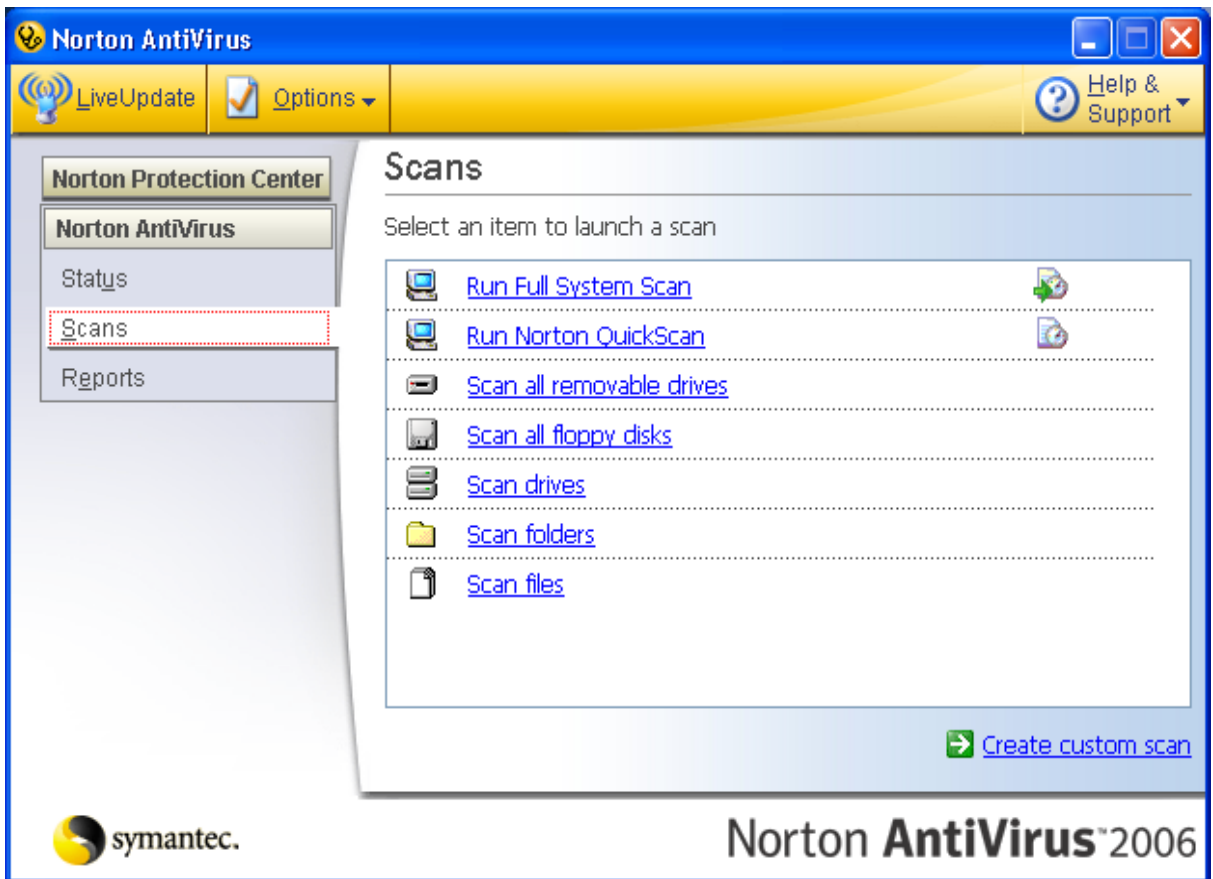

3. In the **Scans** panel, click **Run Full System Scan**.
4. When the scan is complete, a scan summary appears. Click **Finished**.

You can schedule customized virus scans that run unattended on specific dates and times or at periodic intervals. If you are using the computer when the scheduled scan begins, it runs in the background so that you do not have to stop working.

For more information, please refer to the Norton AntiVirus Help menu.

Hardware Specification and Configuration

Processor

Item	Specification	
Type	AMD Turion™ 64 X2 dual-core TL-50/TL-52/TL-56/TL-60/TL-62 processor or higher	AMD Sempron™ 3200+/3400+/3500+ or higher
Package	939 pin lidded micro PGA	754 pin lidded micro PGA
Feature	<ul style="list-style-type: none"> Compatible with Existing 32-bit code base Integrated memory controller: 128-bit DDR SDRAM at 100/133/166/200MHz Dual-core architecture: discrete L1 and L2 cache structures for each core HyperTransport™ Technology to I/O devices: one 16-bit link supporting speed up to 1GHz (2000 MT/s) or 4 GB/s in each direction 	<ul style="list-style-type: none"> Compatible with Existing 32-bit code base Integrated memory controller: 64-bit DDR SDRAM at 100/133/166/200MHz HyperTransport™ Technology to I/O devices: one 16-bit link supporting speed up to 800MHz (1600 MT/s) or 3.2 GB/s in each direction
On-die second (L2) cache	1024KB	512KB

System Board Major Chips

Item	Specification
Core logic	ATi RS485MC + ATi SB460
Super I/O controller	SMSC SIO1036
Audio controller	Codec ALC883
Video controller	Integrated VGA solution for ATi RS485MC
HDD controller	ATi SB460
Keyboard controller and battery management unit	ENE KB910
Card bus PCMCIA controller	ENE CB714 (used ENE 1410 when without Card reader function)
LAN controller	RTL8110SBL
IEEE 1394	VIA VT6311S

Hard Disk Drive

Seagate				
Model				
ST9120821A ST9120824A	ST9100824 ST9100825A	ST98823A ST980829A	ST96812A ST960812A	ST9402112A
Formatted Gbytes (512 bytes/sector)				
120	100	80	60	40
Physical read/write head				
4	4	3	ST96812A: 3 ST960812A: 2	2
Discs				

Hard Disk Drive

Seagate				
2	2	2	ST96812A: 2 ST960812A: 1	1
Spindle Speed (RPM): 4200 (ST9120824A, ST9100825A, ST980829A, ST960812A, ST9402112A) 5400 (ST9120821A, ST9100824A, ST98823A, ST96812A)				
I/O data transfer rate (Mbytes/sec. max.): 100				
ATA data transfer mode supported: PIO modes 0-4; Multiword DMA modes 0-2; Ultra DMA modes 0-5				
Voltage tolerance: +5.0V +/- 5%				

WD		
Model		
WD400UE-22HCT0	WD600UE-22HCT0	WD800UE-22HCT0
Formatted Gbytes (512 bytes/sector)		
40	60	80
Physical read/write head		
2	3	4
Discs		
1	2	2
Spindle Speed (RPM):		
4200	5400	5400
I/O data transfer rate (Mbytes/sec. max.):		
100 ultra DMA mode-5	100 ultra DMA mode-5	100 ultra DMA mode-5
ATA data transfer mode supported:		
ATA/ATAPI-6; ATA-6	ATA/ATAPI-6; ATA-6	ATA/ATAPI-6; ATA-6
Bytes per sector:		
512	512	512
Max. media transfer rate (disk-buffer, Mbytes/sec.)		
372	350	350
Voltage tolerance		
+5.0V +/- 5%	+5.0V +/- 5%	+5.0V +/- 5%

BIOS

Item	Description
BIOS vendor	Phoenix
System BIOS version	Phoenix BIOS V0.17A

BIOS

Item	Description
Feature	<ul style="list-style-type: none">• Acer UI support• Multi-boot support• 1MB flash RIOM for system BIOS• Suspend to RAM (S3) / Disk (S4)• Various hot keys for system control• Support boot option: HDD/Removable device (media bay device)/all USB ports• Support protocols: SMBIOS 2.3, PCI2.2, WFM2.0• ACPI 2.0/3.0 compliance with Intel Speedstep support C1, C2, C3, C4, S3 and S4 for mobile CPU• DMI utility for BIOS serial number configurable/asset tag• Y2K solution support• BIOS virus protection• WinFlash support• Wake on LAN from S3• Wake on LAN from AC mode• D to D support

System Memory

Item	Description
Chip	ATi SB460
Feature	<ul style="list-style-type: none">• 256/512/1024MB + two 1.8V JEDEC standard 200-pin DDRII SODIMM memory module connectors• Adjustable 128MB UMA VGA memory share from system memory

VGA

Item	Description
Chip	ATi RS485MC
Features	<ul style="list-style-type: none">• VGA memory up to 128MB• Display core frequency of 200MHz• 3D graphics engine• Analog display support• Dedicated 2FP (local flat panel) interface: single or dual channel LVDS panel support up to SWXGA + panel, resolution with frequency range from 25MHz to 115MHz per channel• Discrete: 64/128MB with hyper memory technology up to 512MB (64MB + 448MB or 128MB + 384MB) in OS• UMA: shared 256MB in OS

PCMCIA

Item	Description
PCMCIA controller	ENE CB714
Features	<ul style="list-style-type: none">• PC Card 95 supported with one Type II• PCI card bus

ENE CB714 Card Bus Host Adapter

Item	Description
Feature	<ul style="list-style-type: none"> • 3.3V operation with I/O 5V tolerance • LFBGA 169-ball package • Pinout compatible with ENE CB1410 • PCI interface <ol style="list-style-type: none"> 1. Compliant with PCI Local Bus Specification Revision 2.3 2. Compliant with PCI Bus PW Management Interface Specification Revision 1.1 3. Compliant with PCI Mobile Design Guide Version 1.1 4. Compliant with Advanced Configuration and Power Interface Specification Revision 1.0 • CardBus Interface <ol style="list-style-type: none"> 1. Compliant with PC Card Standard 8.0 2. Standardized Zoomed Video Register Model support 3. SPKOUT CAUDIO and RIOUT# • Secure Digital Interface <ol style="list-style-type: none"> 1. Compliant with SD Host Controller Standard Specification Version 1.0 2. SD Suspend/Resume Functionality support 3. DMA mode to minimize CPU overhead support 4. High speed with the SD clock frequency up to 50MHz support 5. Contain two 512-byte buffer to maximize the transfer speed 6. Traffic LED light support 7. Over current protection support • Memory Stick Interface <ol style="list-style-type: none"> 1. Compliant with Memory Stick PRO Format Specification Version 1.0 2. 4-bit parallel data transfer mode support 3. Memory stick clock frequency up to 40MHz 4. DMA mode to minimize CPU to overhead 5. Traffic LED light support • SmartMedia/xD-Picture Interface <ol style="list-style-type: none"> 1. Compliant with SmartMedia Standard 2003 2. Compliant with xD - PictureCard™ Card Specification Version 1.0 3. Hardware ECC (1-bit correction and 2-bit detection) Generation 4. DMA mode to minimize CPU overhead 5. Traffic LED light support • Interrupt Configuration <ol style="list-style-type: none"> 1. Parallel PCI Interrupts support 2. Parallel IRQ and Parallel PCI interrupts 3. Serialized IRQ and PCI interrupts • Power Management Control Logic <ol style="list-style-type: none"> 1. CLKRUN# protocol support 2. SUSPEND# support 3. PCI PME# from D3, D2, D1 and D0 support 4. PCI PME# from D3 cold support • Zoomed Video port • Parallel 4-wire power switch interface

Audio

Item	Description
Audio controller	Realtek ALC833 Azadia Codec
Feature	<ul style="list-style-type: none"> • HD Audio • SNR > 85 • Codec specification requires: <ol style="list-style-type: none"> 1. HD Audio interface 2. 10 DAC (7.1ch + 2CH); 2 ADC 3. DAC SNR >= 95dB, ADC SNR >= 85dB 4. 2 pins with DTS logo codec 5. S/PDIF out support 6. All DACs support 44.1K/48K/96K/192K sample rate 7. All ADCs support 44.1K/48K/96/192K sample rate 8. At least 2 GPIOs for customized applications • One internal array analog microphone • Two speakers, at least 1W/9cc for each

LAN

Item	Description
LAN controller	Realtek RTL8100CL
Feature	<ul style="list-style-type: none"> • 10/100Mbps operation • 10/100Mbps • WOL from S5 support • File deployment support
Connector type	RJ-45

Wireless LAN

Item	Description
Card type	Mini-PCI
Features	<ul style="list-style-type: none"> • 802.11b/g • Built-in two antenna • Wi-Fi, WPA2, WMM CCX V3 and above support • To be placed on the top of LCD on the sides of LCD latches

Modem

Item	Description
Controller	ATi SB460
Features	<ul style="list-style-type: none"> • 56K, V.90/V.92, WWDA • Wake-on-Ring support • CISPR22 application • MDC 1.5 card
Connector type	RJ-11

Keyboard

Item	Description
Model name	New Acer Ergo Keyboard

Keyboard

Item	Description
Features	<ul style="list-style-type: none"> • Touch pad with 4-way integrated scroll button • Windows keys and application keys support • Standard pitch, 2.5 mm travel length • Hotkey controls • Embedded numeric keypad • Multi-language support • Spill-proof • Four easy-launch buttons: Internet browser, E-mail with LED, Acer Empowering, one user-programmable button

Battery

Item	Specification
Vendor & model name	Panasonic/Sanyo/Sony
Features	<ul style="list-style-type: none"> • Li-Ion • 8-cell of 18650 Li-Ion battery pack (2200mAh cell) • 6-cell of 18650 Li-Ion battery pack (2000mAh cell) • 4-cell of 18650 Li-Ion battery pack (2000mAh cell)

TV Tuner (for selected models)

Item	Description
Features	<ul style="list-style-type: none"> • Mini PCI type • 3 TV tuner modules at least: <ol style="list-style-type: none"> 1. Analog with HW MPEG2 2. Analog + Digital with HW MPEG2 (Hybrid) 3. Analog + Digital without HW MPEG2 (Hybrid)

LCD 15.4" WXGA

Item	Specification			
Vendor & Model name	QDI QD15AL02-01 QD15AL02-02	QDI QD15TL07-01 QD15TL07-02	LPL LP154W01-TLE1 LP154W01-TLD1	CMO N154I2-L01 N154I2-L02
Screen Diagonal	15.4" WXGA	15.4" WXGA	15.4" WXGA	15.4" WXGA
Active area	331.2 (W) x 207.0 (H)	331.2 (W) x 207.0 (H)	331.2 (W) x 207.0 (H)	335.0 (W) x 210.7 (H)
Display resolution	1680 x 3 (RGB) x 1050	1280 x 3 (RGB) x 800	1280 x 3 (RGB) x 800	1280 x 3 (RGB) x 800
Display mode	normally white	normally white	normally white	normally white
Surface treatment	<ul style="list-style-type: none"> • QD15AL02-01 non-glare + Hardness 3H • QD15AL02-02 glare + Hard Coating 3H 	<ul style="list-style-type: none"> • QD15TL07-01 non-glare + Hardness 3H • QD15AL07-02 glare + Hard Coating 3H 	<ul style="list-style-type: none"> • LP154W01-TLE1 non-glare + Hard Coating 3H • LP154W01-TLD1 glare + Hard Coating 2H 	<ul style="list-style-type: none"> • N154I2-L01 non-glare + Hard Coating 3H • N154I2-L02 glare + Hard Coating 3H
Pixel arrangement	RGB vertical stripe	RGB vertical stripe	RGB vertical stripe	RGB vertical stripe

LCD 15.4" WXGA

Item	Specification			
Pixel pitch (mm)	0.1971 (H) x 0.1971 (V)	0.2588 (H) x 0.2588 (V)	0.25875 (H) x 0.25875 (V)	0.2588 (H) x 0.2588 (V)
Typical white luminance (cd/m ²) also called brightness	200 (typical)	185 (typical)	200 (typical)	200 (typical)
Contrast ratio	400 (typical)	400 (typical)	400 (typical)	400 (typical)
Respond time (msec.)	Rise: 6 Decay: 10	Rise: 6 Decay: 10	Rise: 6 Decay: 10	Rise: 5 Decay: 11
Normal input voltage of power supply	+3.3V (typical)	+3.3V (typical)	+3.3V (typical)	+3.3V (typical)
Power consumption (watt)	4.38 (typical)	4.38 (typical)	4.2 (typical)	4.2 (typical)
Weight	585g	585g	560g	540g
Physical size (mm)	344.5 (W) x 222.5 (V) x 6.5 (T)	344.0 (H) x 222.0 (V) x 6.35 (T)	344.0 (W) x 222.0 (H) x 6.5 (D)	344.0 (W) x 222.0 (H) x 6.2 (D)
Electrical interface	2 channels LVDS	1 channel LVDS	LVDS	30-pin LVDS interface
Color support	262,144 colors	262,144 colors	262,144 colors	262,144 colors

LCD 15" XGA

Item	Specification			
Vendor & Model name	QDI QD150XL06-03-01	LPL LP150X08-TLA2	CMO N150X3-L9	AUO B150XG02 V4
Screen Diagonal	15" XGA	15" XGA	15" XGA	15" XGA
Active area	304.13 (W) x 228.1 (H)	304.128 (W) x 228.096 (H)	304.1 (W) x 228.1 (H)	304.1 (W) x 228.1 (H)
Display resolution	1024 x 3 (RGB) x 768	1024 x 3 (RGB) x 768	1024 x 3 (RGB) x 768	1024 x 3 (RGB) x 768
Display mode	normally white	normally white	normally white	normally white
Surface treatment	glare + Hardness 3H	non-glare + Hard Coating 3H	non-glare + Hard Coating 3H	non-glare + Hardness 3H
Pixel arrangement	RGB vertical stripe	RGB vertical stripe	RGB vertical stripe	RGB vertical stripe
Pixel pitch (mm)	0.297 (H) x 0.297 (V)	0.297 (H) x 0.297 (V)	0.297 (H) x 0.297 (V)	0.297 (H) x 0.297 (V)
Typical white luminance (cd/m ²) also called brightness	160 (typical)	170 (typical)	200 (typical)	170 (typical)
Contrast ratio	300 (typical)	250 (typical)	250 (typical)	300 (typical)
Respond time (msec.)	Rise: 8 Decay: 17	Rise: 10 Decay: 20	Rise: 5 Decay: 11	Rise: 16 Decay: 9

LCD 15" XGA

Item	Specification			
Normal input voltage of power supply	+3.3V (typical)	+3.9V (typical)	+3.3V (typical)	+3.3V (typical)
Power consumption (watt)	3.96 (typical)	4.76 (typical)	3.96 (typical)	3.9 (typical)
Weight	570g	530g	550g	585g
Physical size (mm)	317.3 (W) x 242.0 (H) x 5.9 (D)	317.3 (W) x 241.5 (H) x 5.9 (D)	317.3 (W) x 242 (H) x 5.7 (D)	317.3 (W) x 242 (H) x 5.7 (D)
Electrical interface	1 channel LVDS	LVDS	LVDS	1 channel LVDS
Color support	262,144 colors	262,144 colors	262,144 colors	262,144 colors

AC Adaptor

Item	Specification	
Vendor & Model name	LiteOn PA-1900-04AW	Delta 90W ADP-90SB BBAA
Input feature		
Rated voltage	for 100Vac or 240Vac input AC voltage	for 100Vac or 240Vac input AC voltage
Input voltage range	from 90Vac to 264Vac	from 90Vac to 265Vac
Rated frequency	for 50Hz or 60Hz	for 50Hz or 60Hz
Frequency range	from 47Hz to 63Hz	from 47Hz to 63Hz
Steady AC current	less than 1.5A rms at 100Vac input and maximum load	less than 1.5A rms at 100Vac input and maximum load
Output feature		
Rated voltage	19V	19V
Voltage range	18.05V to 20V	from 18.2V to 19.8V
Rated power	90 W	90 W
Output ripple and noise	less than 300mVp-p	less than 300mVp-p
Turn on delay time	within two seconds at 115 Vac input voltage	within two seconds at 115 Vac input voltage
Temperature	Operating: 0 to 40°C Non-operating: -31 to 60°C	Operating: 0 to 40°C Non-operating: -31 to 60°C

24X Combo Drive Interface

Item	Specification		
Vendor & model name	PHILIPS SCB5265	LITEON SSC-2485K	HLDS GCC-4244N
Performance Specification			
Transfer rate (KB/sec.)	Sustained: DVD: Max 10.56Mbytes/sec. CD: 3600Kbytes/sec.	Sustained: DVD: Max. 10.15Mbytes/sec. CD: 3500Kbytes/sec.	Sustained: DVD: Max. 11.08Mbytes/sec. CD: 3600Kbytes/sec.

Item	Specification		
Access Time (Typical)	DVD: Random Access: 125 ms DVD: Full Stroke: 165ms CD: Random Access:105ms CD: Full Stroke:160ms	DVD: Random Access: 100 ms DVD: Full Stroke: 190ms CD: Random Access:95ms CD: Full Stroke:180ms	DVD: 120 ms (average) CD: 110 ms (average)
Buffer Memory	2MB	2MB	2MB
Interface	Compliant to ATA/ATAPI-5	ATA/ATAPI-6, MMC-3 and SFF8090 Ver5, Revision 1.2.	N/A
Applicable disc format	<ul style="list-style-type: none"> DVD (read): DVD 5, 9, 10, 18, DVD-ROM, DVD-Video, DVD-R 3.95G, DVD-R 4.7G, DVD-RW, DVD+R, DVD+RW, Multi-Border DVD-R/DVD-RW, Multi-Session DVD+R, DVD+RW, DVD-RAM CD (read): CD-DA, CD ROM Mode-1, CD-ROM/XA Mode-2 Form-1 and Mode-2 Form-2, CD-I, Video-CD (MPEG-1), CD-Text CD (write): CD-DA, CD-ROM Mode-1, CD-ROM/XA Mode-2 Form-1 and Mode-2, CD-i, Video-CD, CD-Text 	CD: CD-DA, CD-ROM Mode-1, CD-ROM XA Mode-2 Form-1 and Form-2, CD-I Ready, Video-CD(MPEG-1), Karaoke-CD, PhotoCD (Multi-Session), Enhance CD, CD extra, I-Trax CD and UDF	<ul style="list-style-type: none"> DVD (read): DVD-ROM single layer 4.7GB/dual layer 8.5GB, DVD-R 3.95GB/4.7GB, DVD-RW 4.7GB, DVD-RAM 2.6GB/4.7GB CD (read): CD-ROM Mode-1, CD-ROM XA, CD-Audio, Mixed Mode CD-ROM (Audio and Data Combined), Photo-CD (Single and Multi-session), CD-I, Video CD, CD-Plus/CD-Extra, CD-Text, CD-R disc, CD-RW disc CD (write): CD-ROM Mode-1, CD-ROM XA, CD-Audio, Mixed Mode (Audio and Data Combined), CD-I, Video CD, CD-Plus/CD-Extra, CD-Text
Loading mechanism	Manual load	Manual load	Manual load
Power Requirement	Max. 1300mA	Max. 1200mA	Max. 1800mA
Input Voltage	5 V +/- 5% (Operating)	5 V +/- 5% (Operating)	5 V +/- 5% (Operating)

8X Super Multi Interface

Item	Specification		
Vendor and model name	Liteon SSM 8515S	Pioneer DVR-K16RS	Philip SDVD-8821
Performance Specification			
Transfer rate read (KB/sec.)	Sustained: <ul style="list-style-type: none"> DVD: 10.00Mbytes/sec. CD: 3500kbytes/sec. 	Sustained: <ul style="list-style-type: none"> DVD: 10.80Mbytes/sec. CD: 3600kbytes/sec. 	Sustained: <ul style="list-style-type: none"> DVD: 10.90Mbytes/sec. CD: 3650kbytes/sec.

Item	Specification		
Access time / Seek time	<ul style="list-style-type: none"> • DVD: random access 130ms • DVD: full stroke 250ms • CD: random access 110ms • CD: full stroke 220ms 	<ul style="list-style-type: none"> • Access time: DVD 160 msec; CD 150 msec. • Random seek time: DVD 150 msec; CD 140 msec. • Full stroke seek time: DVD 300 msec; CD 290 msec. 	<ul style="list-style-type: none"> • Random access: DVD 130ms; CD 130ms • Full stroke: DVD 200ms; CD 240ms
Buffer memory	2MB	2MB	2MB
Interface	compliant to ATA/ATAPI-6, MMC-4 and SFF8090 Ver5	compliant to SFF8020, SFF8090	compliant to ATA/ATA-5
Applicable disc format	CD-DA, CD-ROM Mode-1, CD-ROM/XA Mode-2 Form-1 and Mode-2 Form-2, CD-I, Video-CD (MPEG-1), CD-Text, PhotoCD, Enhance CD, CD extra, I-Trax CD and UDF DVD-ROM, DVD-Video, DVD-Audio, DVD-R single/multi border, DVD+R single/multi session, DVD-RW, DVD+RW, DVD-RAM	KODAK Photo CD single and multi-session, CD Extra (CD PLUS), Video CD, CD text data (read/write), CD-R (read/write), DVD-ROM, DVD-R (read/write), DVD-R DL (read/write), DVD-RW (read/write), DVD+RW (read/write), DVD+R (read/write), DVD+R DL (read/write), DVD+RW (read/write), DVD+RW high speed (read/write), DVD-RAM (read/write)	<ul style="list-style-type: none"> • DVD read: DVD-5, DVD-9, DVD-10, DVD-18, DVD-Video, DVD-Audio, SACD (Hybrid), DVD-R, DVD-R DL, DVD-R 3.95GB, DVD-R Authoring, DVD-R multi-border, DVD-RW, DVD+R, DVD+R DL, DVD+R Multi-session, DVD+RW, DVD-RAM V1.0, DVD-RAM V2.1; CD read: CD-DA, CD-ROM Mode-1, CD-ROM/XA Mode-2 Form-1 and Mode-2 Form-2, CD-i, CD-i Bridge, Video-CD (MPEG-1), Karaoke CD, Photo-CD, Enhanced CD, CD Plus, CD Extra, i-trax CD, CD-Text, CD-R, CD-RW • DVD write: DVD Data, DVD-video; CD write: CD-DA, CD-ROM Mode-1, CD-ROM/XA Mode-2 Form-1 and Mode-2 Form-2, CD-i, Video-CD, CD-text
Loading mechanism	Load: manual load/DC brushless motor system	N/A	N/A
Power requirement	Max. 1500mA	Max. 1800mA	Max. 1300mA
Input voltage	+5V +/- 5% (operating)	+5V +/- 5% (operating) +5V +/- 8% (start-up)	+5V +/- 5% (operating)

Item	Specification
Vendor and model name	HLDS GMA-4082N
Performance Specification	
Transfer rate read (KB/sec.)	Sustained: <ul style="list-style-type: none"> • DVD: 11.08Mbytes/sec. • CD: 3600kbytes/sec.
Access time / Seek time	<ul style="list-style-type: none"> • DVD: random access 160ms • DVD: full stroke 260ms • CD: random access 140ms
Buffer memory	2MB
Interface	compliant to ATA/ATAPI-6, MMC-4 and SFF8090 Ver5
Applicable disc format	CD-DA, CD-ROM Mode-1, CD-ROM/XA Mode-2 Form-1 and Mode-2 Form-2, CD-I, Video-CD (MPEG-1), CD-Text, PhotoCD, Enhance CD, CD extra, I-Trax CD and UDF DVD-ROM, DVD-Video, DVD-Audio, DVD-R single/multi border, DVD+R single/multi session, DVD-RW, DVD+RW, DVD-RAM
Loading mechanism	Load: manual load/DC brushless motor system
Power requirement	Max. 1500mA
Input voltage	+5V +/- 5% (operating)

Fan True Value Table

Fan	dBA	RPM	on	off
Fan off	24	0	0	-
Speed 1	29	2400	40	35
Speed 2	32	2800	54	48
Speed 3	35	3100	71	53
Speed 4	38	3500	73	65
Speed 5	40	3800	74	68

System Utilities

BIOS Setup Utility

The BIOS Setup Utility is a hardware configuration program built in the BIOS (Basic Input / Output System) of computer. Generally speaking, the computer is already properly configured and optimized, and you do not need to run this utility.

However, if you encounter configuration problems, you may need to run Setup. Otherwise, you can also refer to Chapter 4 Troubleshooting when problem arises.

Invoking BIOS Setup

To activate the BIOS Utility, press **m** during POST (when “Press <F2> to enter Setup” message is prompted on the left-bottom side of the screen).

There are six prime items in the BIOS Setup Utility. They are Information, Main, Advanced, Security, Boot and Exit. In the coming pages, we will explain the BIOS Setup Utility by item.

Part	Description
Information	Display the system informations.
Main	Allows the user to specify standard IBM PC AT system parameters.
Security	Provides security setting of the system.
Boot	Allows the user to specify the boot options.
Exit	Allows the user to save CMOS setting and exit Setup.

NOTE: During setup, all Fn function keys and power saving function are disabled.

Information

PhoenixBIOS Setup Utility

Info.	Main	Advanced	Security	Boot	Exit
-------	------	----------	----------	------	------

CPU Type: AMD Turion (tm) 64 X2 Mobile Technology
CPU Speed: 1600 MHz

HDD Model Name: ST9120821AS-(PM)
HDD Serial Number: 5PL08H08
ATAPI Model Name: MATSHITADVD-RAMUJ-8-(SM)
ATAPI Serial Number:

System BIOS Version: V0.17A
VGA BIOS Version: ATi 009.012.001.005

EC BIOS Version: V0.17A
Serial Number: HCW5021012617000C01601
Asset Tag Number:

Product Name: Aspire 5110
Manufacturer Name: Acer
UUID: 37363032313033353761000FB0F34EC7

F1 Help	↑↓ Select Item	F5/F6 Change Values	F9 Setup Defaults
Esc Exit	←→ Select Menu	Enter Select ▶ Sub-Menu	F10 Save and Exit

- CPU type: This item will show the CPU information of the system.
- CPU speed: This item will show the COU clock speed.
- HDD model name: The hard disk model name is automatically detected by the system. If there is no hard disk present or unknown type, "None" should be shown on this field.
- HDD serial number: If no hard disk or other devices are installed on primary IDE master, it will display a blank line.
- System BIOS version: This field reports BIOS version of the system.
- VGA BIOS version: This field reports VGA BIOS version of the system.
- Serial Number: This item is the serial number of the system.
- Asset Tag Number: This item is the asset tag number of the system.
- UUID: It shows only when an internal LAN device is available.

Main

PhoenixBIOS Setup Utility					
Info.	Main	Advanced	Security	Boot	Exit
System Time: [14:13:43] System Date: [05/12/2006] System Memory: 633 KB Extended Memory: 1046528 KB Video Memory: 128 MB Quiet Boot: [Enabled] Power on Display: [Auto] Network Boot: [Enabled] F12 Boot Menu: [Disabled] D2D Recovery: [Enabled]					Item Specific Help <Tab>, <Shift-Tab>, or <Enter> selects field.
F1 Help	↑↓ Select Item	F5/F6 Change Values	F9 Setup Defaults		
Esc Exit	←→ Select Menu	Enter Select	▶ Sub-Menu	F10 Save and Exit	

- System Time and System Date: The hours are displayed with 24-hour format. The changes in these two items take effect immediately.
- System Memory: This item reports the memory size of system base memory. The size is fixed to 640KB.
- Extended Memory: It reports the memory size of the extended memory in the system. The extended memory size is equal to total memory size (one MB).
- Video Memory: It indicates the video memory size.
- Quiet Boot:
 - Enabled: Customer Logo is displayed, and Summary Screen is disabled.
 - Disabled: Customer Logo is displayed, and Summary Screen is enabled.
- Power on Display:
 - Auto: During power on process, the system will detect if any display device is connected on external video port. If any external display device is connected, the power on display will be only in CRT (or projector) mode. Otherwise, it will be in LCD mode.
 - Both: Both the integrated LCD and the external video port (for an external CRT or projector) will be enabled simultaneously.
- Network Boot: It permits the users to boot from network.

-
- F12 Boot Menu:
 - Enabled: When it is enabled, the users can modify device boot priority by pressing <F12> during POST.
 - Disabled: When it is not enabled, device boot priority will not be adjustable during POST.

The boot device change is only for one-time change. In other words, when the system is rebooted, the boot device sequence will be the same as the one defined in the BIOS setup (Boot option).

- D2D Recovery: It allows the users to enable or disable the disk-to-disk recovery.

Advanced

PhoenixBIOS Setup Utility					
Info.	Main	Advanced	Security	Boot	Exit
Enable ACPI (debug only): Infrared Port (FIR) Advanced Chipset Control			[Yes] [Enabled]	Item Specific Help	
				En/Disable ACPI BIOS (Advanced Configuration and Power Interface) Debug only, remove this option for production.	
F1 Help	↑ ↓ Select Item	F5/F6 Change Values	F9 Setup Defaults		
Esc Exit	← → Select Menu	Enter Select ▶ Sub-Menu	F10 Save and Exit		

- Enable ACPI (debug only): Enable/Disable ACPI (Advanced Configuration and Power Interface) debug only, remove this option for production.
- Infrared Port:
 - Disabled: No configuration
 - Enabled: User configuration
 - BIOS or OS chooses configuration

Security

PhoenixBIOS Setup Utility					
Info.	Main	Advanced	Security	Boot	Exit
Supervisor Password Is: Clear User Password Is: Clear HDD Password Is: Clear Set Supervisor Password [Enter] Set User Password [Enter] Set HDD Password [Enter] Password on Boot: [Disabled]				Item Specific Help Supervisor Password controls accesses of the setup utility. It can be used to boot up when Password on boot is enabled.	
F1 Help	↑ ↓ Select Item	F5/F6 Change Values	F9 Setup Defaults		
Esc Exit	← → Select Menu	Enter Select	▶ Sub-Menu	F10 Save and Exit	

The system supports three levels of password protection. The password support consists of a Supervisor Password, User Password, and Hard Disk Password. All the passwords are stored in a non-volatile storage device (EEPROM).

- Password Policy:

All the passwords will obey the following rules:

- All the passwords can be set or cleared in BIOS Setup Security screen.
- The password entry consists of eight alphanumeric characters. At least one character must be assigned.
- The valid keys are listed in the table below:

Symbol Character	Symbol Name
A-Z	letters A to Z (not case sensitive)
0-9	numerical characters
-	dash
=	equal sign
[left bracket

Symbol Character	Symbol Name
]	right bracket
.	period
,	comma
;	semi-colon
/	slash
\	back slash

- The users can not change or remove password during resuming from S4.
- The max. number of times to retry the password is limited to three.
- Supervisor Password:

Supervisor Password controls the access of the whole BIOS Setup Utility. If the Supervisor Password is set, the system will pop up the password dialog box to ask for the password when the users press <F2> for entering BIOS Setup Utility.

If the Supervisor Password is set and Password on boot is enabled, the system will pop up the password dialog box to ask for the password when the system is powered on or resumes for S4 state.

If the users fail three times consecutively in password verification, the system will be hung up and the users need to manually power off the system.

- User Password:

If the User Password is set, the system will pop up the password dialog box to ask for the password when the users press <F2> for entering BIOS Setup Utility.

If the Supervisor Password is not set at first, the User Password can not be set. If the Supervisor Password is cleared, the User Password will be cleared, too.

If the User Password is set and Password on boot is enabled, the system will pop up the password dialog box to ask for the password when the system is powered on or resumes for S4 state.

If the users fail three times consecutively in password verification, the system will be hung up and the users need to manually power off the system.

- Set Supervisor Password / User Password:
 - Highlight the item and press “Enter”, a dialog box will be shown to ask the users to enter new password and confirm new password.
 - If the users want to reset password, a current password will be required to be tapped in at first. If the current password is correct, the users are permitted to enter new password and confirm new password for verification. If the verification is OK, the password setting will be complete after the users press “Enter”.
 - If the password entered does not match the current password, a dialog box will be shown to ask to re-enter the password.
- Set HDD Password: When shown as “Locked”, the hard drive password currently can not be changed or disabled. To change or disable it, turn off the system and enter Setup immediately after turning it back on. Press “Enter” to input change, or disable hard drive password.
- Password on Boot: It allows the user to specify whether or not a password is required to boot.

Boot

PhoenixBIOS Setup Utility					
Info.	Main	Advanced	Security	Boot	Exit
Boot priority order: 1: SATA: ST9120821AS-(S1) 2: IDE 1: 3: IDE 0: MATSHITADVD-RAM UJ-845S-(PM) 4: PCI BEV: Realtek Boot Agent 5: USB HDD: 6: USB CDROM: 7: USB FDD: 8: USB KEY:				Item Specific Help Keys used to view or configure devices: Up and Down arrows select a device, then press <F6> to move it up the list, or <F5> to move it down the list. Press <Esc> to exit the menu.	
F1 Help	↑↓ Select Item	F5/F6 Change Values	F9 Setup Defaults		
Esc Exit	←→ Select Menu	Enter Select	▶ Sub-Menu	F10 Save and Exit	

This menu allows the users to decide the order of bootable devices to load the operating system. It identifies all the bootable devices in the system and attempts to boot them in the order specified. Bootable devices include the diskette drive in module bay, the hard disk and the CD-ROM/DVD drive in module bay and onboard LAN device.

Exit

PhoenixBIOS Setup Utility					
Info.	Main	Advanced	Security	Boot	Exit
Exit Saving Changes Exit Discarding Changes Load Setup Defaults Discard Changes Save Changes					Item Specific Help
					Exit System Setup and save your changes to CMOS.

F1 Help	↑↓ Select Item	F5/F6 Change Values	F9 Setup Defaults
Esc Exit	←→ Select Menu	Enter Select	▶ Sub-Menu F10 Save and Exit

- Exit Saving Changes: It allows the users to save changes to CMOS and reboot the system.
- Exit Discarding Changes: The users can exit the Setup not to save changes.
- Load Setup Defaults: It allows the users to load default values in CMOS Setup.
- Discard Changes: The users can discard previous changes in CMOS Setup.
- Save Changes: The users can save current changes in CMOS Setup.

DOS Flash SOP

1. Press <F2> to enter Setup Menu, select Boot page to change boot device priority order. Use USB as an example.

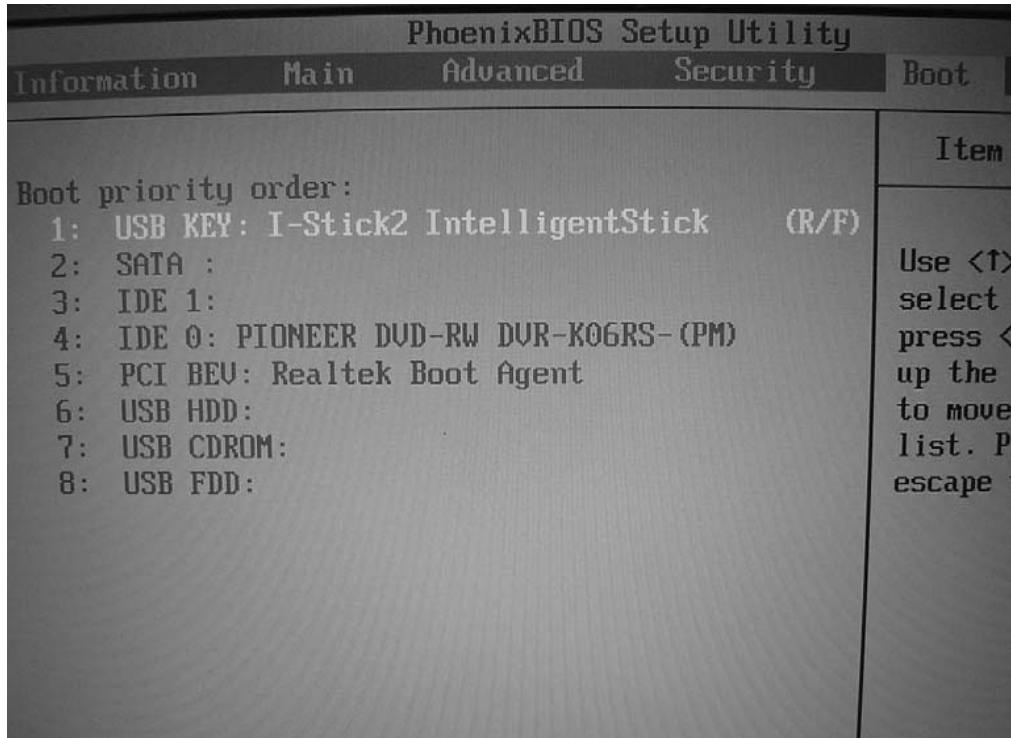

2. Execute the BIOS.BAT or FLASH.BAT batch file to update BIOS.

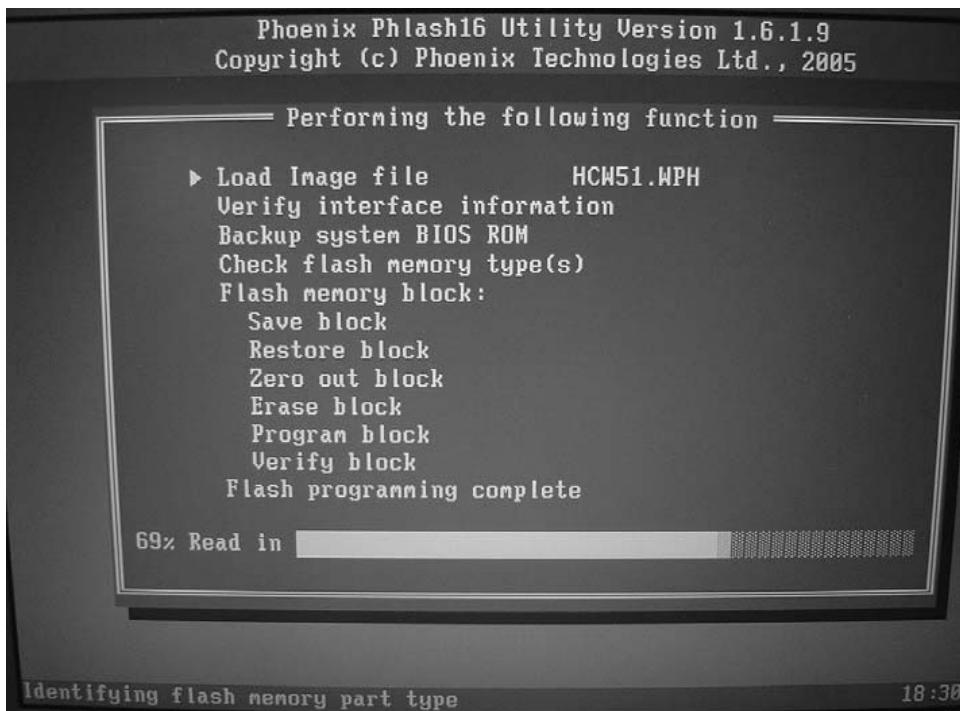

3. In flash BIOS, the caution message **Please do not remove AC power source** will show. If AC power source is plugged, the caution message **AC adapter does not exist**.

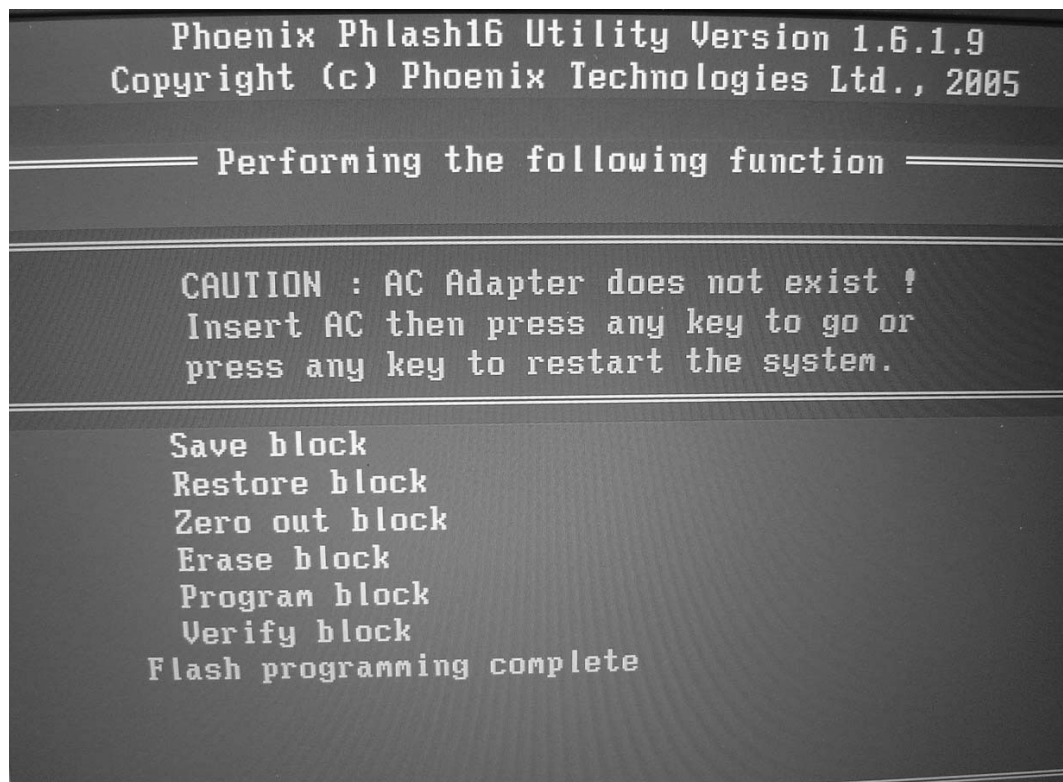
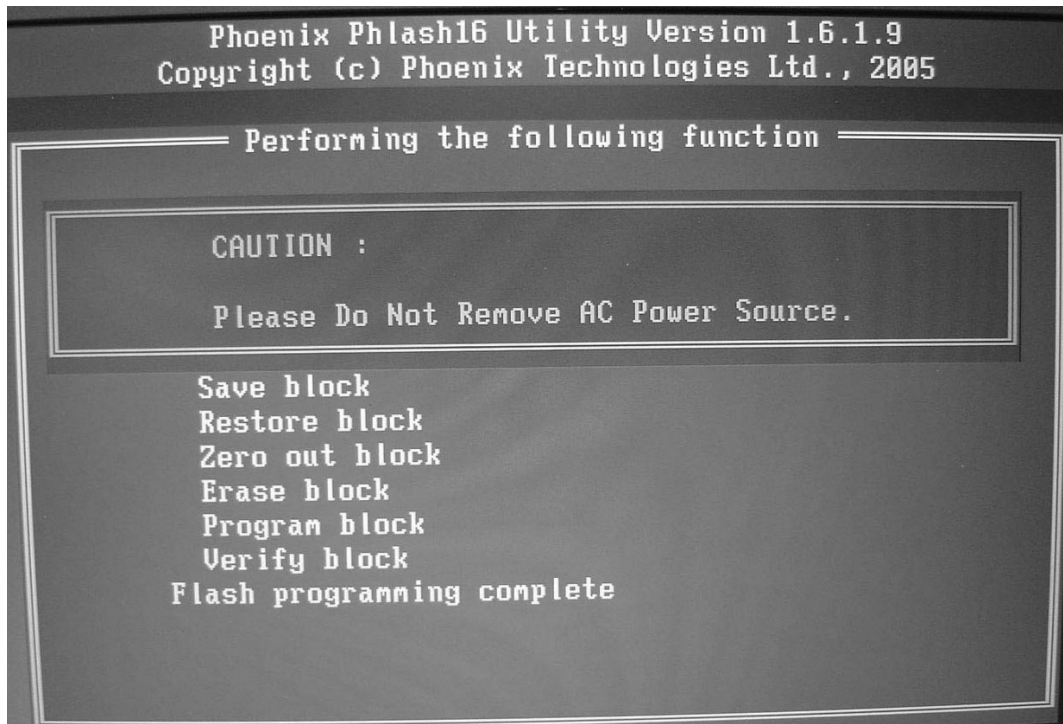

Machine Disassembly and Replacement

This chapter contains step-by-step procedures on how to disassemble the notebook for maintenance and troubleshooting. Here, we take an Aspire 5110 as sample for disassembly.

To disassemble the computer, you need the tools below:

- Wrist ground strap and conductive mat for preventing electrostatic discharge
- Small Philips screw driver
- Flat head screw driver
- Hexagonal driver
- Tweezers

NOTE: The screws for the different components vary in size. During the disassembly process, group the screws with the corresponding components to avoid mismatch when putting back the components. When you remove the stripe cover, please be careful not to scrape the cover.

General Information

Before You Begin

Before proceeding with the disassembly procedure, you have to make sure that:

1. The system and all peripherals are powered off.
2. The AC adaptor and all power and signal cables from the system are unplugged.
3. The battery pack is removed.

NOTE: There are several types of screws used to secure the main unit. The screws vary in length. Please refer to the screws table after the flowchart. Group the same type of screws together during service disassembling. Please also remember the screw location for each screw type. If you fasten the screws on the wrong location, the long screws may cause irrecoverable damage to the main board.

Disassembly Procedure Flowchart

The flowchart gives you a graphic representation on the entire disassembly and reassembly and instructs you how to remove the components.

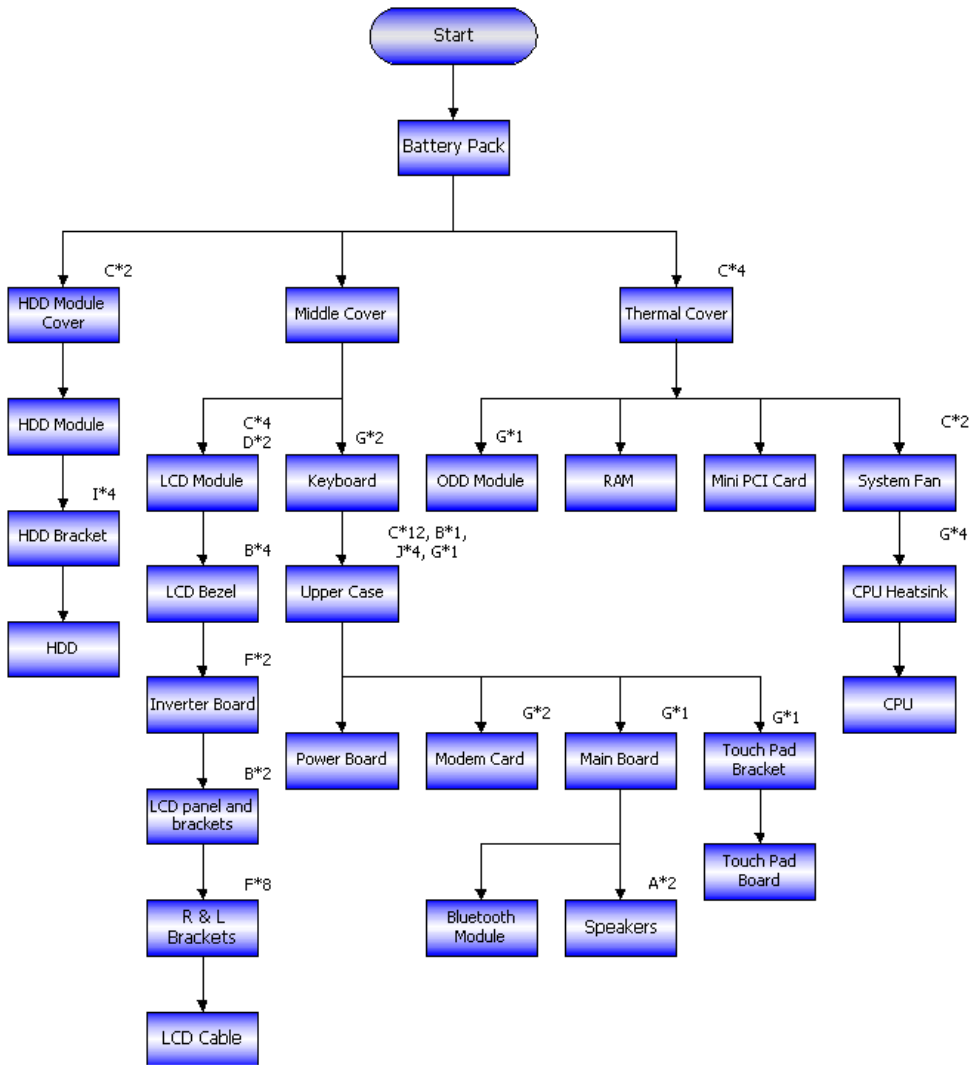

Screws List

No.	Description	Part No.
a	SCREW M2.5*3(NL)	86.ADWW5.001
b	SCREW M2.5*6(NL)	86.ADWW5.002
c	SCREW M2.5*10(NL)	86.ADWW5.003
d	SCREW M2.5*15(NL)	86.ADWW5.004
e	SCREW M2*2.2	86.ADWW5.005
f	SCREW M2*3-B (NL)	86.ADWW5.006
g	SCREW M2*3-S (NL)	86.ADWW5.007
h	SCREW M2*4	86.ADWW5.008
i	SCREW M3*4 (NL)	86.ADWW5.009

Screws List

No.	Description	Part No.
j	SCREW D-SUB 4#X40*1/5-NI (NL)	86.AD WV5.010

Disassembly Procedure

Removing the Battery Pack

1. Slide the battery lock to the end as the arrow indicates.
2. The battery pack will pop up then remove it.



Removing the HDD Module

1. Release the two screws fastening the HDD module cover.
2. Detach the HDD module cover.
3. Pull the HDD module then lift the HDD module as the arrow indicates then detach the HDD module.

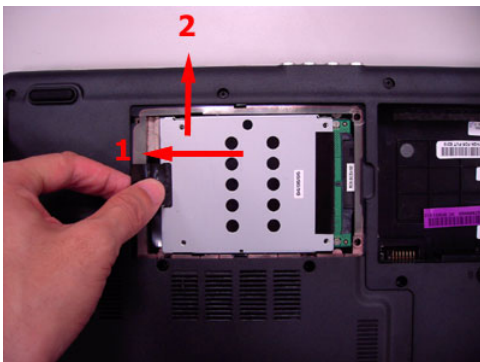
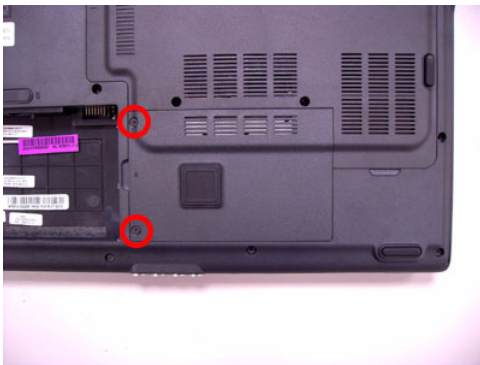

Removing the RAM Module/Mini PCI Card/Thermal Module/CPU

1. Release the four screws holding the thermal module cover.
2. Remove the thermal module cover.
3. Pull the RAM module locks at the same time as the arrows indicate.
4. The RAM module will pop up then detach it. Repeat the anterior step to remove another RAM module.
5. Pull the Mini PCI card locks at the same time as the arrows indicate.
6. The Mini PCI card will pop up then detach it.
7. Disconnect the auxiliary antenna cable (gray) and the main antenna cable (black).

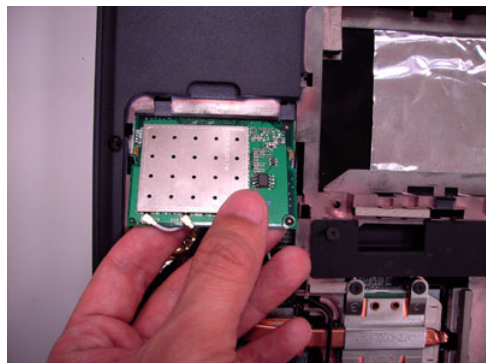
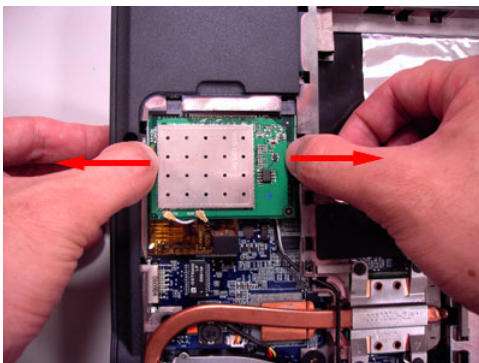
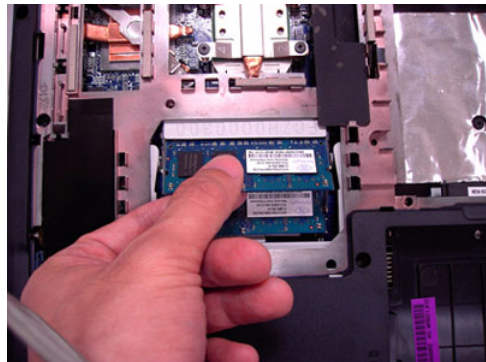
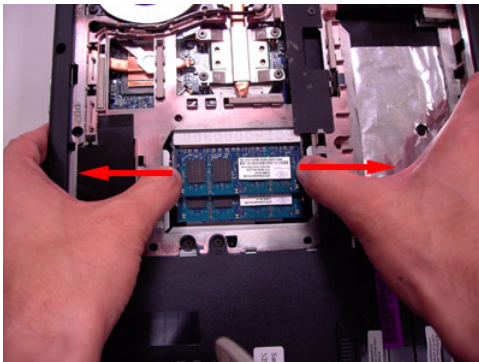
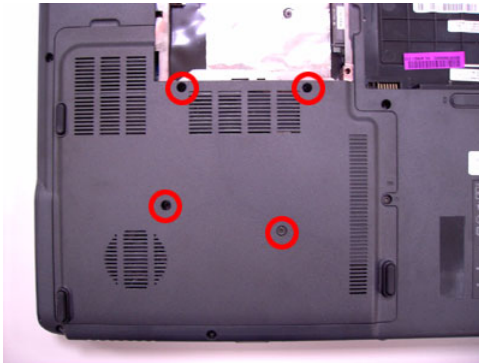

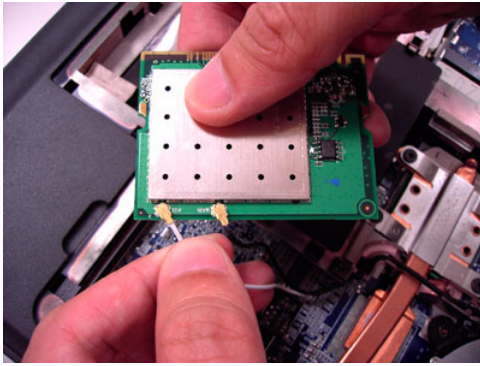

8. Release the two screws securing the system fan.
9. Disconnect the system fan cable carefully the remove the system fan.
10. Release the four screws securing the CPU heatsink.
11. Remove the CPU heatsink as the arrow indicates.
12. Counter clockwise release the screw securing the CPU using a flat head screw driver.
13. Carefully detach the CPU.

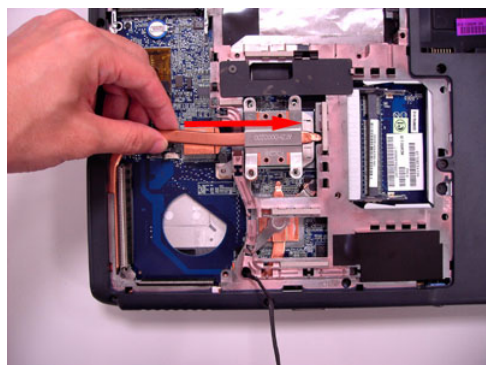
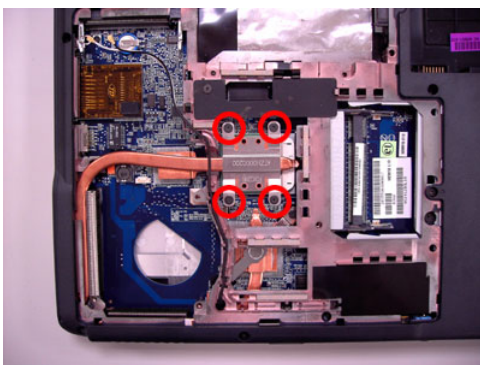
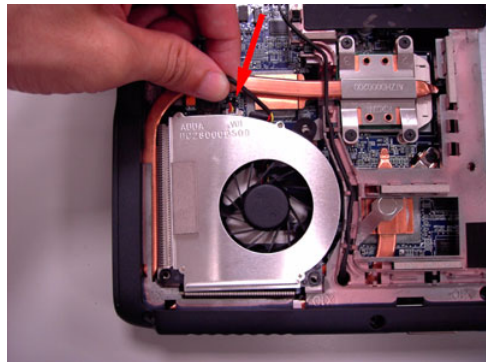

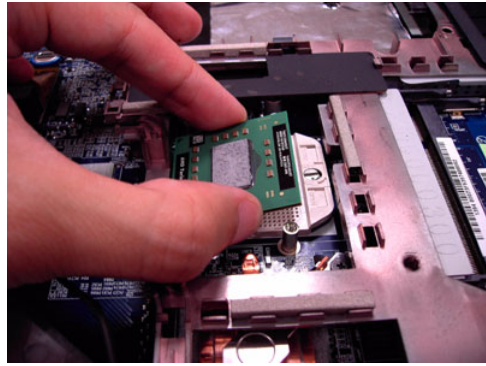
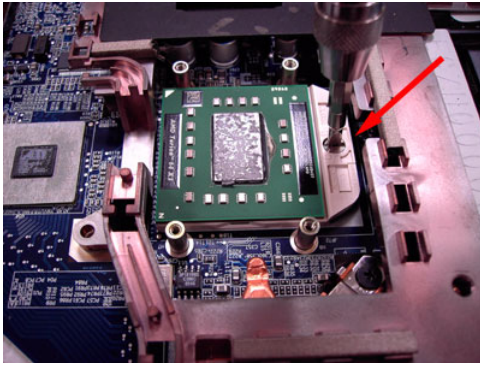

Removing the ODD Module

If you just want to replace the ODD module, you do not have to remove the anterior components. Please skip the anterior steps of disassembly. After you remove the battery pack and the thermal module cover, follow the steps below.

1. Release the screw securing the ODD module.
2. Push the ODD module using a screwdriver as shown.
3. Remove the ODD module from the main unit.

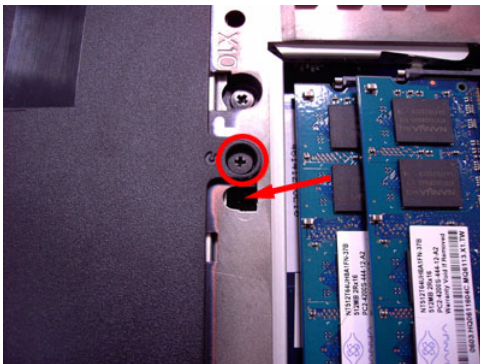

Removing the LCD Module from the Main Unit

If you just want to replace or check the LCD module, you can skip all the main unit disassembly procedures. After removing the battery pack, please follow the steps below.

1. Open the notebook as shown.
2. Remove the middle cover from the edge of the middle cover.
3. Carefully detach the middle cover.
4. Carefully disconnect the LCD cable.
5. Slightly pull out the wireless antenna cables.



6. Release the two screws holding the LCD module on the bottom side of the main unit.
7. Release the four screws securing the LCD hinges on the main unit.
8. Then detach the LCD module from the main unit.

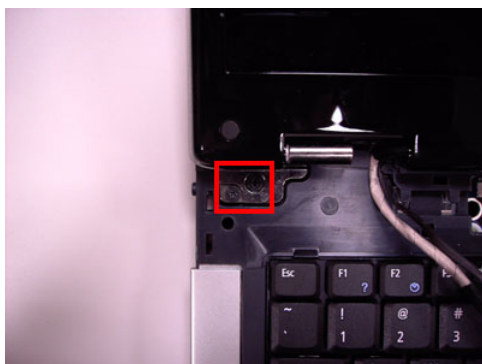

Removing the Keyboard

If you just want to replace the keyboard, skip the LCD module disassembly. After you remove the middle cover, follow the steps below.

1. Release the two screws securing the keyboard plate.
2. Carefully detach the keyboard plate from the edge of the keyboard plate and place the keyboard plate as shown.
3. Release the keyboard FFC lock carefully because it is fragile. Then remove the keyboard plate.

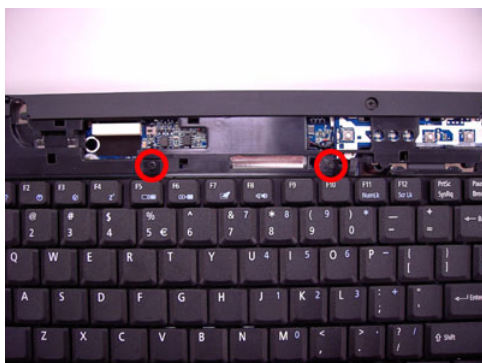

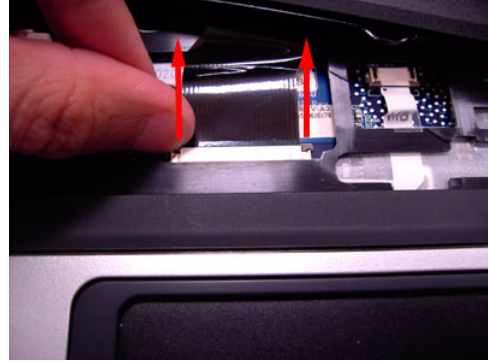

Disassembling the Main Unit

Separating the Upper Case and the Lower Case

1. Carefully release the media board FFC lock because it is fragile. Then disconnect the media board FFC.
2. Release the 12 screws securing the upper case and the lower case on the bottom side.
3. Release the four hexagonal screws securing the external VGA port and the DVI-D port.
4. Release the two screws securing the upper case and the lower case on the upper side.
5. Then detach the upper case from the main unit.

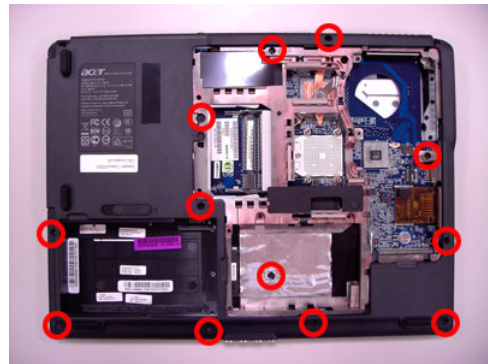
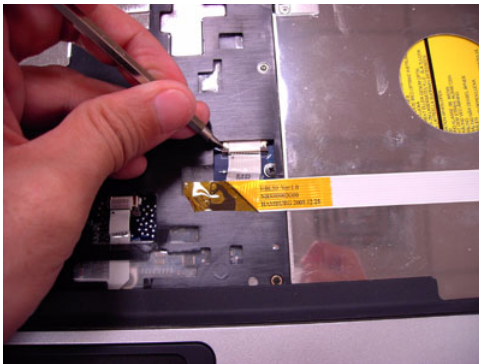



Removing the Power Board and the Modem Board

1. Detach the power board slightly.
1. Release the two screws securing the modem board.
2. Detach the modem board then disconnect the modem board cable.

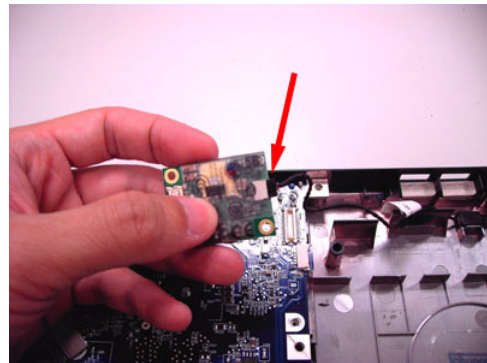
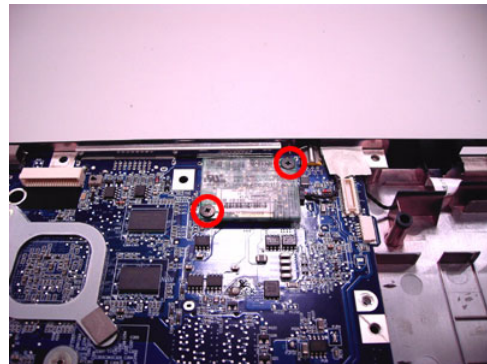
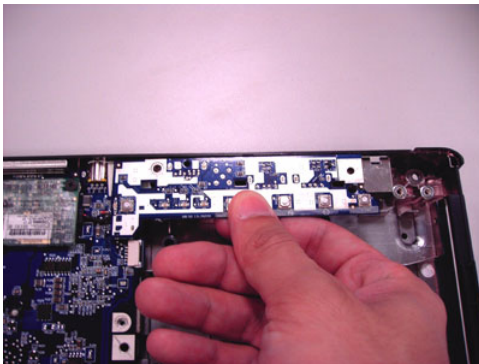

Removing the Main Board

1. Disconnect the speakers cable and the microphone cable.
2. Release the screw securing the main board.
3. Slightly pull the edge of the lower case from the left side and at the same time push the main board on the bottom side to pop up the main board.
4. Repeat Step 3 from the rear side.
5. Then detach the main board. If your system is equipped with Bluetooth module, please place the main board on the lower case as shown. Do not abruptly remove the main board from the lower case.

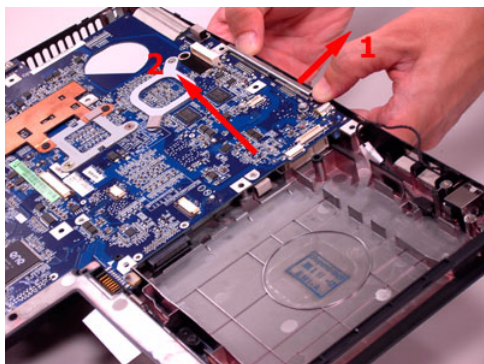
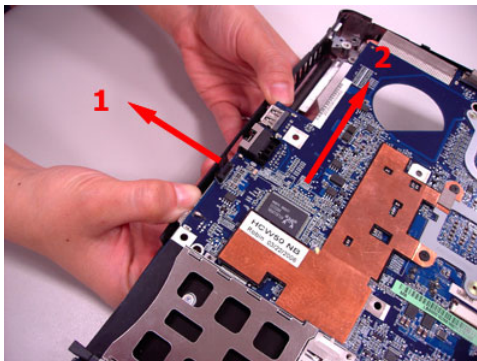
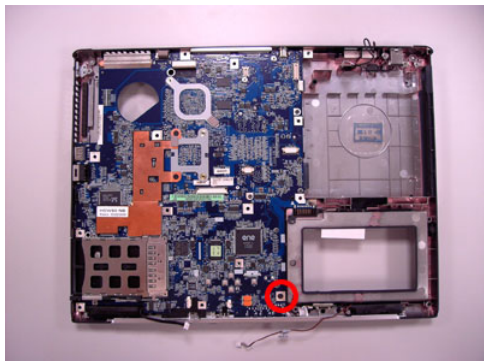
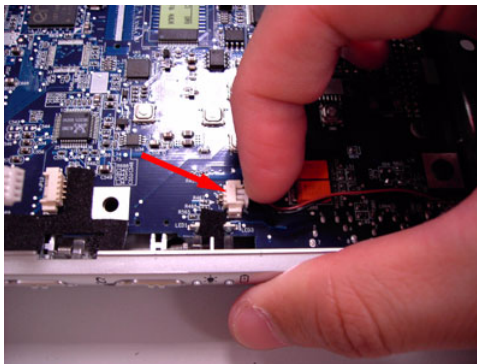
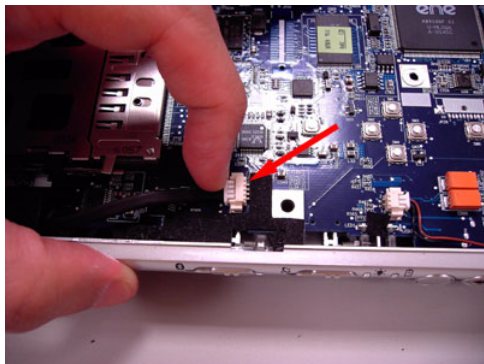

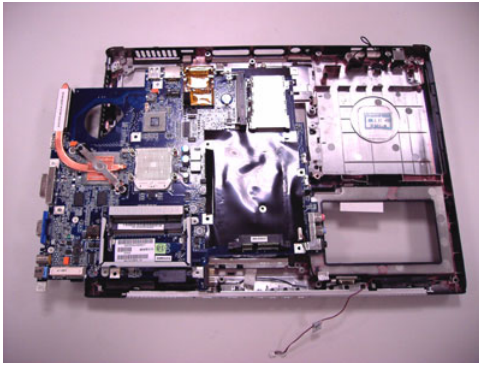

Removing the Bluetooth Module

1. Place the main board as shown.
2. Tear off the tinsel.
3. Disconnect the Bluetooth module cable and remove the main board.
4. Remove the Bluetooth module.

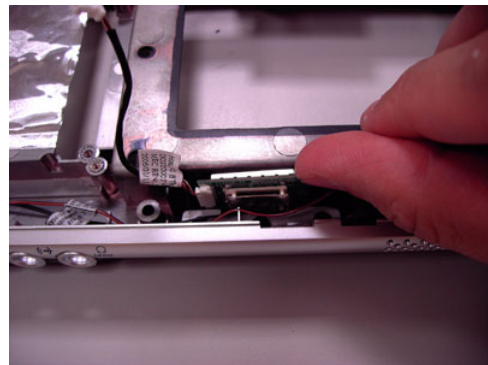
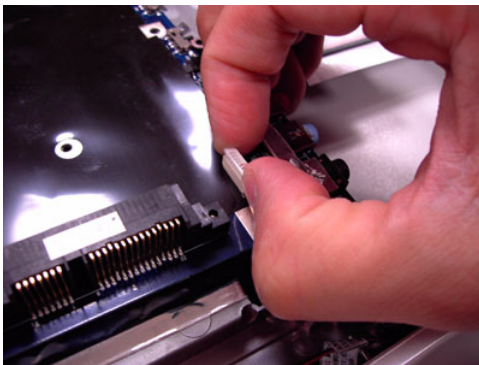
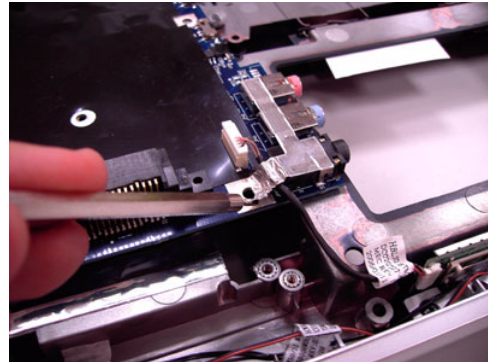
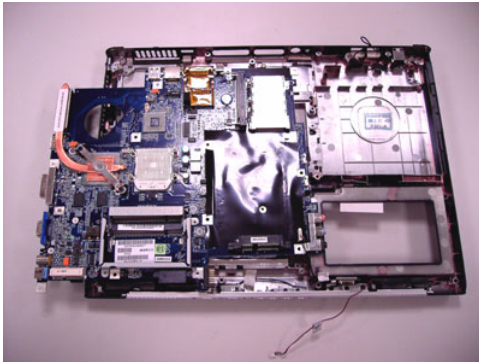

Removing the Speakers

1. Release the two screws securing the speakers.
2. Then detach the speakers.

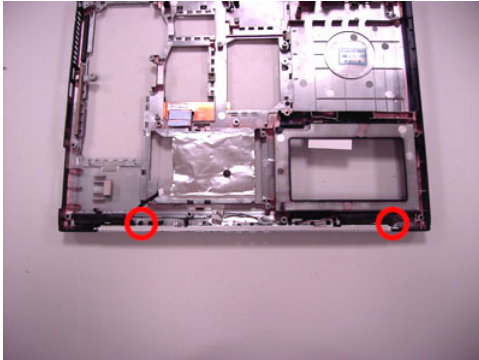

Removing the Touch Pad Board

1. Slightly unlock the touch pad FFC lock by nail and disconnect the touch pad FFC.
2. Release the screw holding the touch pad board bracket then remove the touch pad board bracket.
3. Detach the touch pad board.

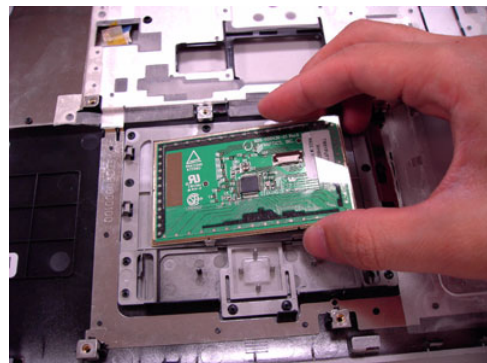
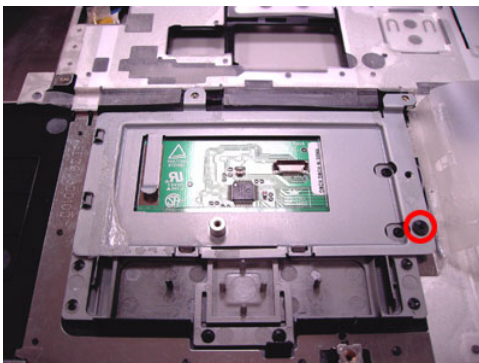
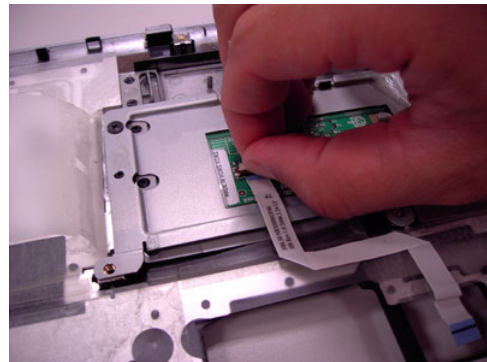
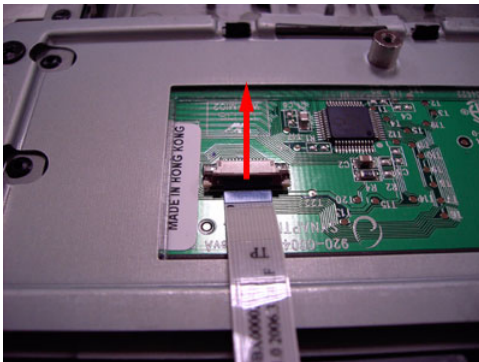

Removing the VGA Heatsink

1. Release the two screws securing the VGA heatsink.
2. Then detach the VGA heatsink.

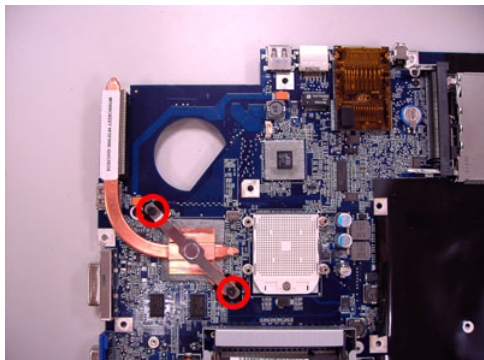

Disassembling the LCD Module

1. Remove the four screw cushions on the LCD bezel then release the four screws holding the LCD bezel.
2. Carefully detach the LCD bezel from the LCD module.
3. Tear off the tapes holding the LVDS cable and the LCD cable then release the two screws securing the inverter board.



- Carefully disconnect the LVDS cable.
- Carefully disconnect the LCD cable then remove the inverter board.
- Release the two screws securing the LCD panel.
- Then detach the LCD panel.
- Release the eight screws holding the left and right LCD brackets and remove the LCD brackets.

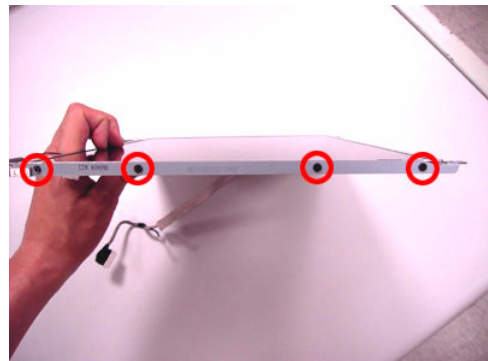
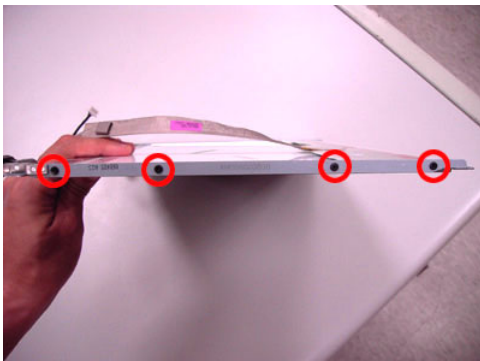
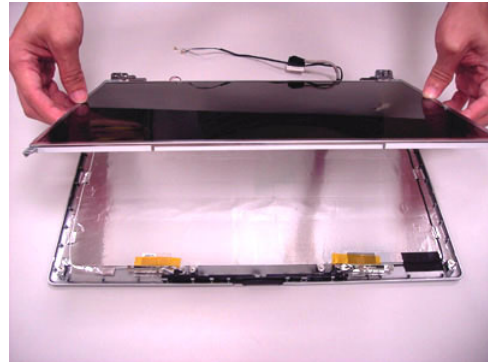
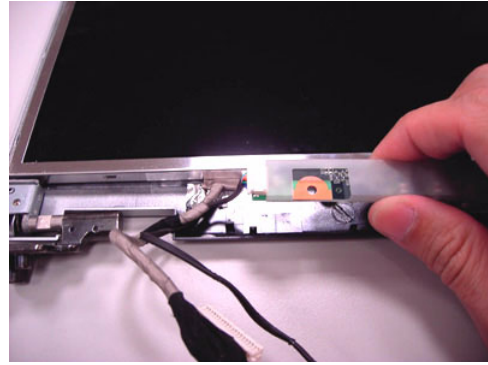
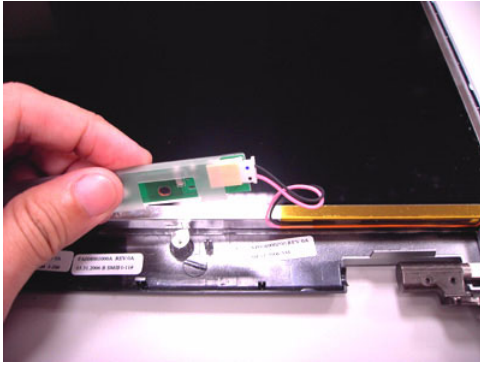

-
9. Tear off the tape holding the LCD cable.
 10. Carefully pull and disconnect the LCD cable.



Troubleshooting

Please use the following procedures as a guide for computer problems.

NOTE: The diagnostic tests are intended to test only Acer products. Non-Acer products, prototype cards, or modified options may occur errors or invalid responses.

1. Obtain the detailed fail symptoms as many as possible.
2. Verify the symptoms by attempting to recreate, running the diagnostic tests or repeating the same operation.

System Check Procedures

External Diskette Drive Check

Do the following procedures to isolate the possible effects from a controller, driver, or diskette. A writable, diagnostic diskette is required.

NOTE: Make sure that the diskette does not have more than one label attached. Multiple labels may cause damage to the drive or make the drive fail.

1. Boot from the diagnostic diskette and start the diagnostic programs.
2. See if FDD test is passed as the programs run the FDD test.
3. Follow the instructions in the message window.

If errors occur with the internal diskette driver, reconnect the diskette connector on the system board. If the errors still remain:

1. Reconnect the external diskette drive.
2. Replace the external diskette driver.
3. Replace the main board.

External CD-ROM Drive Check

Do the following procedures to isolate the possible effects from a controller, driver, or CD-ROM.

NOTE: Make sure that the CD-ROM does not have any label attached. The label may cause damage to the drive or make the drive fail.

1. Boot from the diagnostic diskette and start the diagnostic programs.
2. See if CD-ROM test is passed when the programs run the CD-ROM test.
3. Follow the instructions in the message window.

If errors occur, reconnect the connector on the system board. If the errors still remain:

1. Reconnect the external CD-ROM drive.
2. Replace the external CD-ROM drive.
3. Replace the main board.

Keyboard or Auxiliary Input Device Check

Remove the external keyboard if the internal keyboard is under test. If the internal keyboard does not work or an unexpected error appears, make sure that the flexible cable extending from the internal keyboard is correctly connected on the system board. If the keyboard is correctly connected, run the Keyboard test.

If errors occur, do the following procedures in sequence to correct the problems. Do not replace a non-defective FRU.

1. Reconnect the keyboard cable.
2. Replace the keyboard.
3. Replace the main board.

The following auxiliary input devices are supported by this computer.

- Numeric keypad
- External keyboard

If any of these devices do not function, reconnect the cable and repeat the anterior procedures.

Memory Check

Follow the procedures below to correct the memory errors.

1. Boot from the diagnostic diskette and start the diagnostic programs.
2. Go to the diagnostic memory in the test items.
3. Press F2 in the test items.
4. Follow the instructions in the message window.

NOTE: Make sure that the DIMM is correctly inserted into the connector. A wrong connection will cause errors.

Power System Check

To verify the symptoms, power on the computer by using the following power sources separately.

1. Remove the battery pack.
2. Connect the power adaptor and check the power supply.
3. Disconnect the power adaptor and install the battery pack, then check the power supply.

If you think there is a power supply problem, please go to “Check the Power Adaptor” and “Check the Battery Pack” in this chapter.

Check the Power Adaptor

Unplug the power adaptor cable from the computer and measure the output voltage at the plug of the power adaptor cable. See the illustration and follow the procedures below.

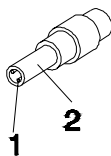

pin 1: +19V to +20.5V
pin 2: 0V, ground

1. If the voltage is not correct, replace the power adaptor.
2. If the voltage is within the range:
 - (1) Replace the system board.
 - (2) If the problem is still not resolved, see “Undetermined Problems”.
 - (3) If the voltage is not correct, go to the next step.

NOTE: An audible noise from the power adaptor does not always indicate a defect.

3. If the power-on indicator does not light up, check the power cord of the power adaptor for continuity and correct installation.
4. If the operational charge does not work, see “Check the Battery Pack”.

Check the Battery Pack

Follow the procedures below to check the battery pack.

From software, this helps to identify the problem is on recharging or discharging.

1. Check the Power Management in Control Panel.
2. Then confirm that the parameters shown in the screen for Current Power Source and Total Battery Power Remaining are correct.
3. Repeat the step 1 and step 2 for both battery and adaptor.

From hardware, this helps to identify whether you should replace the battery pack or not.

1. Power off the system.
2. Remove the battery pack and measure the voltage between terminals one (+) and seven (-). There are seven terminals totally. See the illustration below.

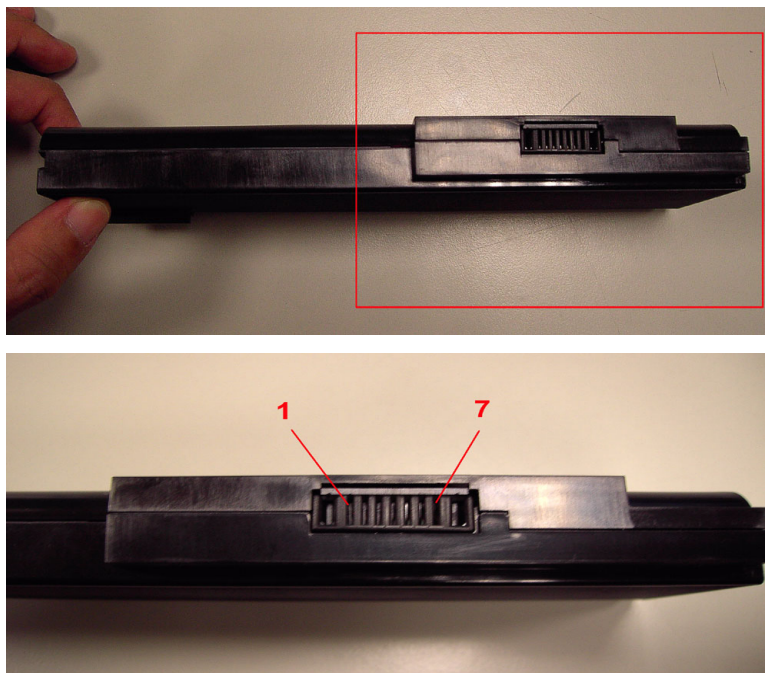

3. If the voltage is still less than 7.5V after recharging, replace the battery.

If the battery status indicator does not light up, remove the battery pack. After the battery pack returns to room temperature, reinstall it to the system.

If the charge indicator does not light up, replace the battery pack. If the charge indicator still does not light up, replace the AC/DC charger board.

Touchpad Check

If the touchpad does not work, follow the procedures one at a time to correct the problem. Do not replace a non-defective FRU.

1. Reconnect the touchpad cables.
2. Replace the touchpad.

3. Replace the system board.

After you use the touchpad, the pointer drifts on the screen for a short time. This self-acting pointer movement will occur when a slight, steady pressure is applied to the touchpad pointer. This symptom is not a hardware problem.

Power-On Self-Test (POST) Error Message

The POST error message index lists the error message and their possible causes.

NOTE: Perform the FRU replacement or actions in the sequence shown in Error Message List, if the FRU replacement does not solve the problem, put the original part back in the computer. Do not replace a non-defective FRU.

The error messages are listed in the coming pages to indicate the BIOS signals on the screen and the error symptoms classified by functions. If the symptom is not included on the list, please refer to **Undetermined Problems**.

NOTE: Most of the error messages occur during POST. Some of them show information about a hardware device, for example, the size of memory installed. Others may indicate problems with a device, such as the way it has been configured.

NOTE: If the system fails after you make changes in the BIOS Setup Utility menus, please reset the computer. Enter Setup and install Setup defaults to correct the errors.

Index of Error Messages

Error Code List

Error Code	Error Message
006	Equipment Configuration Error Causes: 1. CPU BIOS Update Code Mismatch 2. IDE Primary Channel Master Drive Error The causes will be shown before Equipment Configuration Error .
010	Memory Error at xxxx:xxxx:xxxxh (R: xxxxh, W: xxxxh)
070	Real Time Clock Error
071	CMOS Battery Bad
072	CMOS Checksum Error
110	System disabled. Incorrect password is specified.
No error code	Battery critical low: In this situation BIOS will issue four short beeps then shut down system, no message will be shown.
No error code	Thermal critical high: In this situation BIOS will shut down the system, no message will be shown.

Error Message List

Error Message	FRU/Action in Sequence
Failure Fixed Disk	Reconnect hard disk drive connector. Run Load Default Settings in BIOS Setup Utility. Hard disk drive System board
Stuck Key	see Keyboard or Auxiliary Input Device Check .
Keyboard error	see Keyboard or Auxiliary Input Device Check .
Keyboard Controller Failed	see Keyboard or Auxiliary Input Device Check .
Keyboard locked - Unlock key switch	Unlock external keyboard

Error Message List

Error Message	FRU/Action in Sequence
Monitor type does not match CMOS - Run Setup	Run Load Default Settings in BIOS Setup Utility.
Shadow RAM Failed at offset: nnnn	BIOS ROM System board
System RAM Failed at offset: nnnn	DIMM System board
Extended RAM Failed at offset: nnnn	DIMM System board
System battery is dead - Replace and run Setup	Replace RTC battery and Run BIOS Setup Utility to reconfigure system time, then reboot system.
System CMOS checksum bad - Default configuration used	RTC battery Run BIOS Setup Utility to reconfigure system time, then reboot system.
System timer error	RTC battery Run BIOS Setup Utility to reconfigure system time, then reboot system. System board
Real time clock error	RTC battery Run BIOS Setup Utility to reconfigure system time, then reboot system. System board
Previous boot incomplete - Default configuration used	Run Load Default Settings in BIOS Setup Utility. RTC battery System board
Memory size found by POST differed from CMOS	Run Load Default Settings in BIOS Setup Utility. DIMM System board
Diskette drive A error	Check the drive is defined with the proper diskette type in BIOS Setup Utility. See External Diskette Drive Check.
Incorrect Drive A type - run Setup	Check the drive is defined with the proper diskette type in BIOS Setup Utility.
System cache error - Cache disabled	System board
CPU ID:	System board
DMA Test Failed	DIMM System board
Software NMI Failed	DIMM System board
Fail-Safe Timer NMI Failed	DIMM System board
Device Address Conflict	Run Load Default Settings in BIOS Setup Utility. RTC battery System board
Allocation Error for device	Run Load Default Settings in BIOS Setup Utility. RTC battery System board

Error Message List

Error Message	FRU/Action in Sequence
Failing Bits: nnnn	DIMM BIOS ROM System board
Fixed Disk n	None
Invalid System Configuration Data	BIOS ROM System board
I/O device IRQ conflict	Run Load Default Settings in BIOS Setup Utility. RTC battery System board
Operating system not found	Enter Setup and see if fixed disk and drive A: are properly identified. Diskette drive Hard disk drive System board
No beep, power-on indicator turns off and LCD is blank.	Power source (battery pack and power adapter). See Power System Check . Ensure every connector is connected correctly. Reconnect the DIMM. LED board System board
No beep, power-on indicator turns on and LCD is blank.	Power source (battery pack and power adapter). See Power System Check . Reconnect the LCD connector. Hard disk drive LCD inverter ID LCD cable LCD Inverter LCD System board
No beep, power-on indicator turns on and LCD is blank. But you can see POST on an external CRT.	Reconnect the LCD connectors. LCD inverter ID LCD cable LCD inverter LCD System board
No beep, power-on indicator turns on and a blinking cursor shown on LCD during POST.	Ensure every connector is connected tightly and correctly. System board
No beep during POST but system runs correctly.	Speaker System board

POST Code

Code	Beeps	For Boot Block in Flash ROM
E0h		Initialize the chipset.
E1h		Initialize the bridge.
E2h		Initialize the CPU.
E3h		Initialize the system timer.
E4h		Initialize system I/O.
E5h		Check force recovery boot.
E6h		Checksum BIOS ROM.
E7h		Go to BIOS.
E8h		Set Huge Segment.
E9h		Initialize Multi Processor.
EAh		Initialize OEM special code.
EBh		Initialize PIC and DMA.
ECh		Initialize Memory type.
EDh		Initialize Memory size.
EEh		Shadow Boot Block.
EFh		System memory test.
F0h		Initialize interrupt vectors.
F1h		Initialize Run Time Clock.
F2h		Initialize video.
F3h		Initialize System Management Mode.
F4h	1	Output one beep before boot.
F5h		Boot to Mini DOS.
F6h		Clear Huge Segment.
F7h		Boot to Full DOS.

Index of Symptom-to-FRU Error Message

LCD-Related Symptoms

Symptom/Error	Action in Sequence
LCD backlight doesn't work. LCD is too dark. LCD brightness cannot be adjusted. LCD contrast cannot be adjusted.	Enter BIOS Utility to execute Load Setup Default Settings , then reboot system. Reconnect the LCD connectors. Keyboard (if contrast and brightness function key do not work). LCD inverter ID LCD cable LCD inverter LCD System board
Unreadable LCD screen Missing pels in characters Abnormal screen Wrong color displayed	Reconnect the LCD connector. LCD inverter ID LCD cable LCD inverter LCD System board
LCD has extra horizontal or vertical lines displayed.	LCD inverter ID LCD inverter LCD cable LCD System board

Indicator-Related Symptoms

Symptom/Error	Action in Sequence
Indicator incorrectly remains off or on, but system runs correctly.	Reconnect the inverter board Inverter board System board

Power-Related Symptoms

Symptom/Error	Action in Sequence
Power shuts down during operation.	Power source (battery pack and power adapter). See Power System Check . Battery pack Power adapter Hard drive & battery connection board System board
The system doesn't power on.	Power source (battery pack and power adapter). See Power System Check . Battery pack Power adapter Hard drive & battery connection board System board

Power-Related Symptoms

Symptom/Error	Action in Sequence
The system doesn't power-off.	Power source (battery pack and power adapter). See Power System Check . Hold and press the power switch for more than 4 seconds. System board
Battery can't be charged.	See Check the Battery Pack . Battery pack System board

PCMCIA-Related Symptoms

Symptom/Error	Action in Sequence
System cannot detect the PC Card (PCMCIA).	PCMCIA slot assembly System board
PCMCIA slot pin is damaged.	PCMCIA slot assembly

Memory-Related Symptoms

Symptom / Error	Action in Sequence
Memory count (size) appears different from actual size.	Enter BIOS Setup Utility to execute Load Default Settings , then reboot system. DIMM System board

Speaker-Related Symptoms

Symptom/Error	Action in Sequence
In Windows, multimedia programs, no sound comes from the computer.	Audio driver Speaker System board
Internal speakers make noise or emit no sound.	Speaker System board

Power Management-Related Symptoms

Symptom/Error	Action in Sequence
The system will not enter hibernation.	Keyboard (if control is from the keyboard) Hard disk drive System board
The system does not enter hibernation mode and four short beeps every minute.	Press Fn + F4 and see if the computer enters hibernation mode. Touchpad Keyboard Hard disk connection board Hard disk drive System board

Power Management-Related Symptoms

Symptom/Error	Action in Sequence
The system does not enter standby mode after closing the LCD.	LCD cover switch System board
The system does not resume from hibernation mode.	Hard disk connection board Hard disk drive System board
The system does not resume from standby mode after opening the LCD.	LCD cover switch System board
Battery fuel gauge in Windows does not go higher than 90%.	Remove battery pack and let it cool for two hours. Refresh battery (continue to use battery until power off, then charge battery). Battery pack System board
System hangs intermittently.	Reconnect hard disk/CD-ROM drives. Hard disk connection board System board

Peripheral-Related Symptoms

Symptom/Error	Action in Sequence
System configuration does not match the installed devices.	Enter BIOS Setup Utility to execute Load Default Settings , then reboot system. Reconnect hard disk/CD-ROM/diskette drives.
External display does not work correctly.	Press Fn + F5, LCD/CRT/Both display switching System board
USB does not work correctly.	System board
Print problems	Ensure the Parallel Port in the “Onboard Devices Configuration” of BIOS Setup Utility is set to Enabled. Onboard Devices Configuration Run printer self-test. Printer driver Printer cable Printer System Board
Serial or parallel port device problems.	Ensure the Serial Port in the “Devices Configuration” of BIOS Setup Utility is set to Enabled. Device driver Device cable Device System board

Keyboard/Touchpad-Related Symptoms

Symptom/Error	Action in Sequence
Keyboard (one or more keys) does not work.	Reconnect the keyboard cable. Keyboard System board

Keyboard/Touchpad-Related Symptoms

Symptom/Error	Action in Sequence
Touchpad does not work.	Reconnect touchpad cable. Touchpad board System board

Modem-Related Symptoms

Symptom/Error	Action in Sequence
Internal modem does not work correctly.	Modem phone port modem combo board System board

NOTE: If you can not correct the problems according to the anterior tables, see **Undetermined Problems**.

Intermittent Problems

Intermittent system hang problems can be caused by a variety of reasons that have nothing to do with a hardware defect, such as cosmic radiation, electrostatic discharge, or software errors. FRU replacement should be considered only when a recurring problem exists.

When analyzing an intermittent problems, follow the procedures below:

1. Run the advanced diagnostic test for the system board in loop mode at least 10 times.
2. If no error is detected, do not replace any FRU.
3. If any error is detected, replace the FRU. Rerun the test to verify that there are no more errors.

Undetermined Problems

The diagnostic problems does not identify which devices fail, which devices are incorrectly installed, whether a short circuit happens, or whether the system is inoperative.

NOTE: Verify if all devices attached are supported by the computer.

NOTE: Verify if the power supply used at the time of failure is operating correctly. You can refer to “Power System Check”.

Follow the procedures below to isolate the failing FRU. Do not isolate non-defective FRU.

1. Power off the computer.
2. Visually check the devices. If any problems are found, replace the FRU.
3. Remove or disconnect all of the following devices:
 - Non-Acer devices
 - Printer, mouse, and other external devices
 - Battery Pack
 - Hard disk drive
 - DIMM
 - CD-ROM / Diskette drive module
 - PC cards
4. Power on the computer.
5. Determine if the problem has been resolved.
6. If the problem does not recur, reconnect the removed devices one at a time until you find the failed FRU.
7. If the problem remains, replace the following FRU one at a time. Do not replace a non-defective FRU.
 - System board
 - LCD assembly

Jumper and Connector Location

Main Board

Top Side

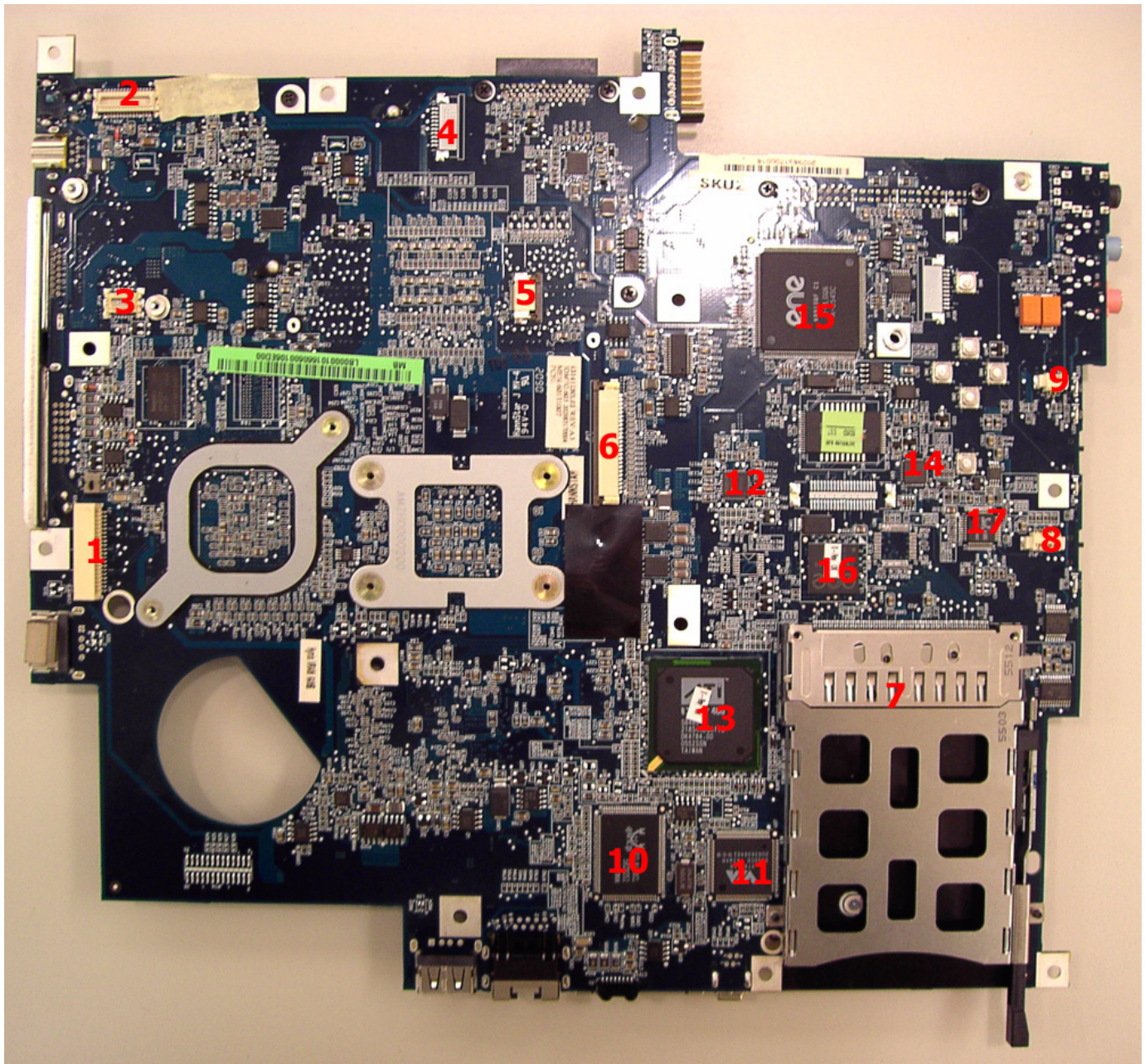

#	Item	Description	#	Item	Description
1	JP1	LCD PANEL CONNECTOR	2	JP2	LED BOARD CONNECTOR
3	JP3	MDC CONNECTOR	4	JP5	MEDIA BOARD CONNECTOR
5	JP6	TOUCH PAD BOARD CONNECTOR	6	JP7	INTERNAL KEYBOARD CONNECTOR
7	JP9	PCMCIA SOCKET	8	JP12	INTERNAL SPEAKER CONNECTOR
9	JP13	INTERNAL MIC CONNECTOR	10	U12	LAN CHIP
11	U14	1349 CHIP	12	U17	BIOS FLASH ROM
13	U18	SOUTH BRIDGE CHIP	14	U25	SUPER I/O
15	U27	EC/KBC CHIP	16	U30	CARD BUS CONTROLLER
17	U33	AUDIO CODEC			

Bottom Side

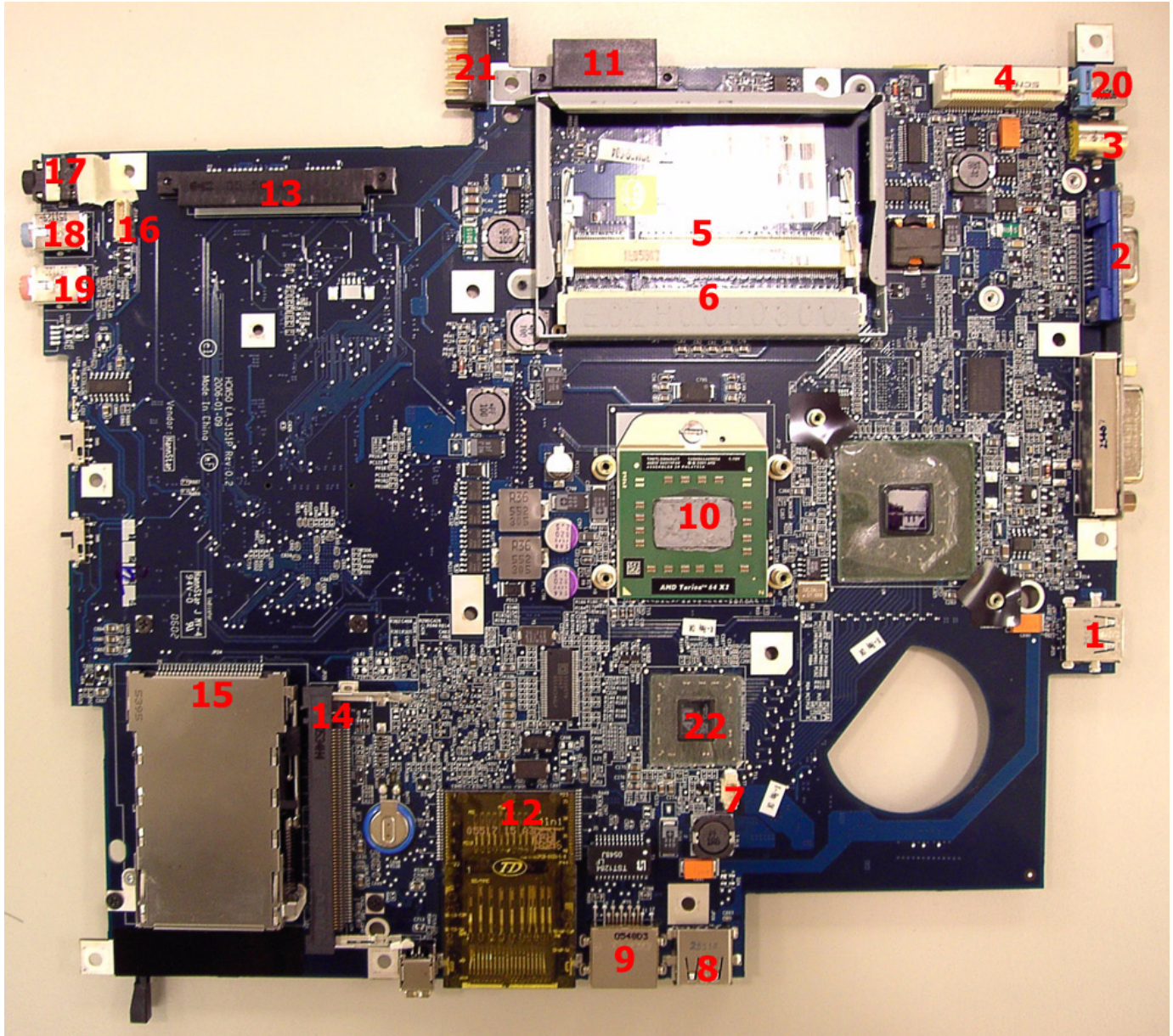

#	Item	Description	#	Item	Description
1	JP14	USB CONNECTOR	2	JP15	CRT CONNECTOR
3	JP16	TV-OUT CONNECTOR	4	JP17	MINI CARD CONNECTOR
5	JP18	DDRII SODIMM SLOT	6	JP19	DDRII SODIMM SLOT
7	JP20	FAN CONNECTOR	8	JP21	USB CONNECTOR
9	JP22	RJ45 CONNECTOR	10	JP23	CPU SOCKET
11	JP24	ODD CONNECTOR	12	JP25	5-in-1 CONNECTOR
13	JP27	HDD (PATA) CONNECTOR	14	JP28	MINI PCI SLOT
15	JP30	NEW CARD SOCKET	16	JP31	BLUETOOTH CONNECTOR
17	JP32	SPDIF OUT JACK	18	JP33	LINE-IN JACK

#	Item	Description	#	Item	Description
19	JP34	MIC JACK	20	PJP1	DC JACK
21	PJP2	BATTERY PACK CONNECTOR	22	U39	NORTH BRIDGE

Switch Board

Top Side

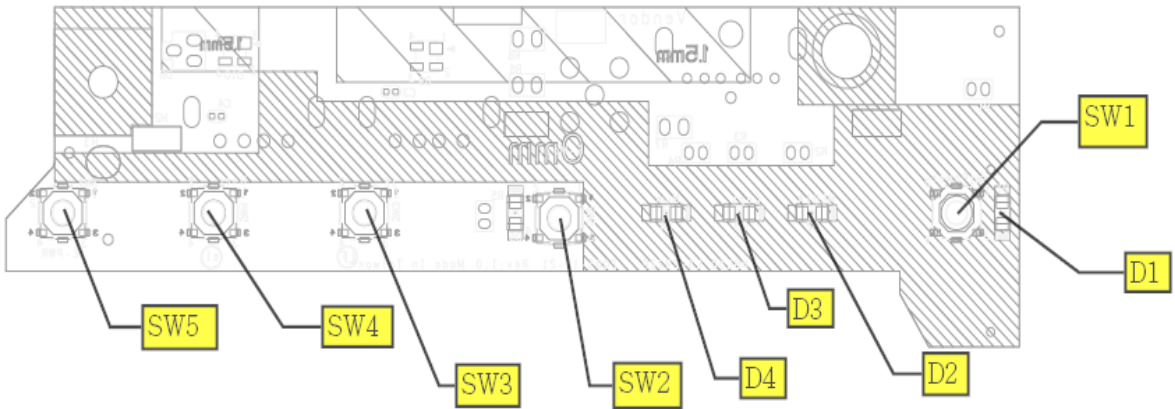

Item	Description
SW1	POWER BUTTON
SW2	E-MAIL BUTTON
SW3	INTERNAL BUTTON
SW4	USER BUTTON
SW5	EMPOWER BUTTON
D1	POWER LED
D2	MEDIA LED
D3	CAPS LED
D4	NUMLK LED
D5	EMAIL LED

Bottom Side

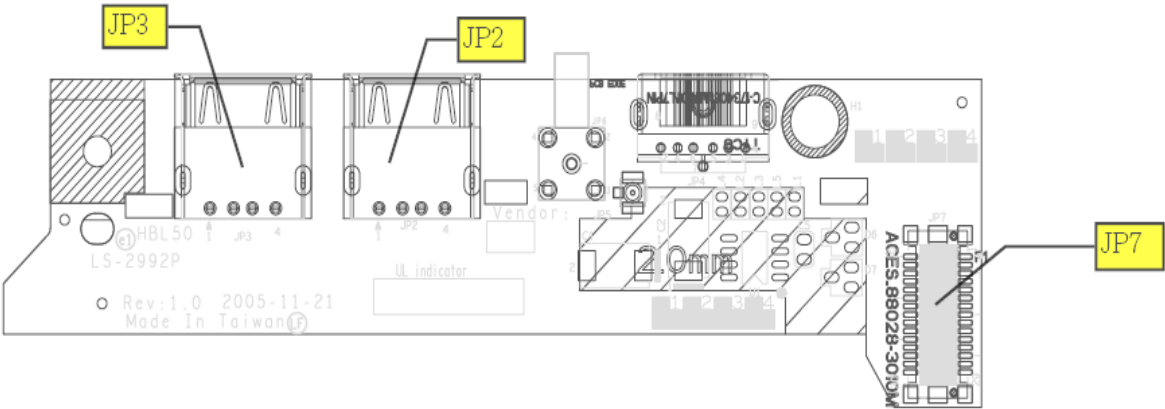

Item	Description
JP2	USB CONNECTOR
JP3	USB CONNECTOR
JP7	LED BOARD CONNECTOR

Clear CMOS

You can short JOPEN1 jump on the main board to erase CMOS data. Please refer to the images below for the location of JOPEN1 jump.

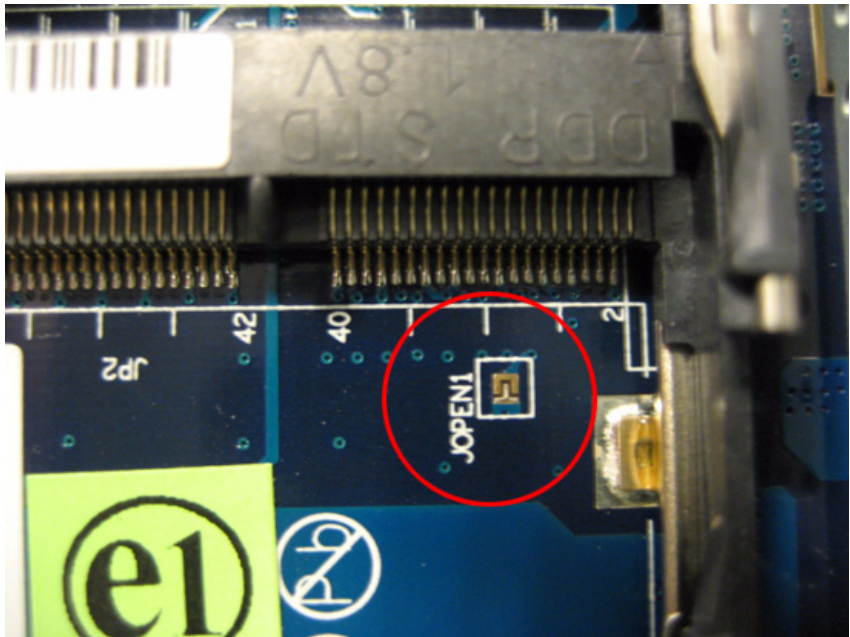
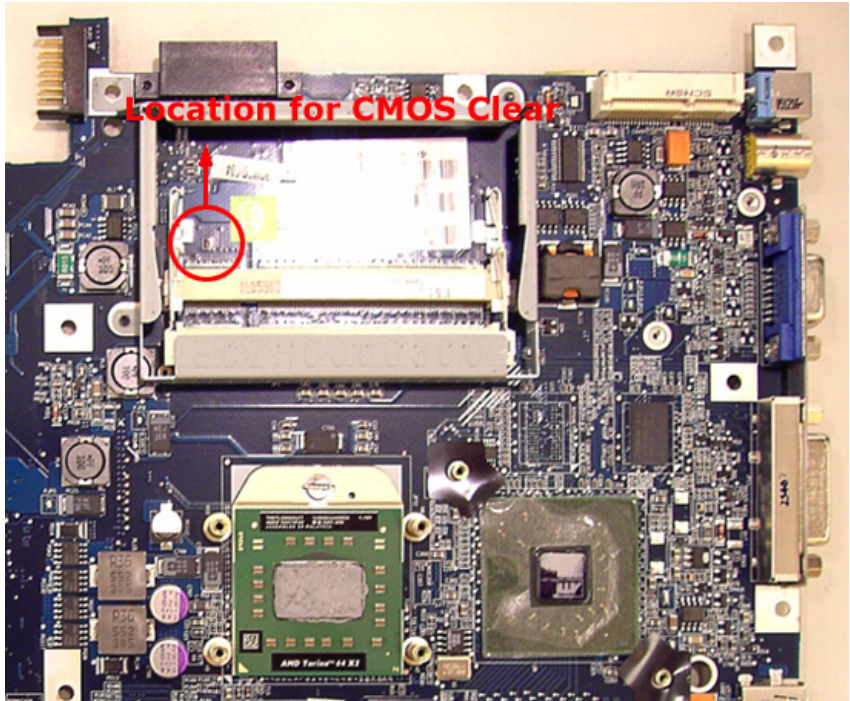

FRU (Field Replacement Unit) List

This chapter offers the FRU (Field Replacement Unit) list in global configuration of Aspire 5110/5100/3100 series. Refer to this chapter whenever you order the parts to repair or for RMA (Return Merchandise Authorization).

Please note that when ordering FRU parts, you should check the most up-to-date information available on your regional web or channel. For whatever reasons a part number is changed, it will NOT be noted on the printed service guide. For Acer authorized service providers, your Acer office may have a different part number code from those given in the FRU list of this printed service guide. You **MUST** use the local FRU list provided by your regional Acer office to order FRU parts for service.

NOTE: To scrap or to return the defective parts, you should follow the local government ordinance or regulations on how to dispose them properly, or follow the rules set by your regional Acer office on how to return it.

Parts

Category	Partname	Acer Part Number
ADAPTER		
N/A	ADAPTER 65W 3PIN LITEON PA-1650-02LR	AP.06503.012
	ADAPTER 65W 3PIN DELTA SADP-65KB DBFF	AP.06501.009
	ADAPTER 90W 3PIN LITEON PA-1900-04LR	AP.09003.006
	ADAPTER 90W 3PIN DELTA ADP-90SB BBAC	AP.09001.009
	ADAPTER 90W 3PIN LI SHIN SLS0202C19A20LF	AP.09006.004
BATTERY		
	BATTERY LI-ION 4 CELLS 2000MAH SONY	BT.00404.008
	BATTERY LI-ION 4 CELLS 2000MAH SANYO	BT.00403.008
	BATTERY LI-ION 4 CELLS 2000MAH PANASONIC	BT.00405.006
	BATTERY LI-ION 6 CELLS 4000MAH SANYO	BT.00603.017
	BATTERY LI-ION 6 CELLS 4000MAH PANASONIC	BT.00605.004
	BATTERY LI-ION 6 CELLS 4000MAH SONY	BT.00604.008
	BATTERY LI-ION 8 CELLS 4800MAH SONY	BT.00804.012
	BATTERY LI-ION 8 CELLS 4800MAH SANYO	BT.00803.015
BOARD		
	MODEM BOARD FOXCONN T60M845.02 SV92A1Z (AC97/ Azalia)	54.ABHV5.001
	BLUETOOTH MODULE FOXCONN T60H928.01 (Broadcom BCM2045)	54.ABHV5.002
	MINI PCI WIRELESS BOARD FOXCONN (ATHEROS) 802.11b/g T60N874.03 (AR2414/AR5413 solution)	54.ABHV5.003
N/A	MINI PCI WIRELESS BOARD FOXCONN (BROADCOM) 802.11b/g T60H906.00 (BCM4318 solution)	54.ABHV5.004
	MINI WLAN (NAVARRO DISCRETE) FOXCONN (ATHEROS) 802.11 a/b/g T60H921.10 (AR5424 solution)	54.ABHV5.005
N/A	MINI WLAN (NAVARRO DISCRETE) FOXCONN (BROADCOM) 802.11b/g T60H938.03 (4311)	54.ABHV5.006
N/A	TV TUNER M103 SW Analog(DVB-T)-Hybird	55.A61V5.007
N/A	TV TUNER M104 H/W Analog	55.A61V5.004
N/A	TV TUNER M115 DTV H/W Analog-Hybird	55.A61V5.005
N/A	MEDIA BOARD	55.AD WV5.001



Category	Partname	Acer Part Number
	SWITCH BOARD-W/TV AS	55.AD WV5.003
N/A	SWITCH BOARD-W/O TV TM/AS	55.ABHV5.001
	INVERTER BOARD - 15 IN.	19.ABHV5.001
N/A	INVERTER BOARD - 15.4 IN.	19.ABHV5.002
CABLE		
	TP FPC- T/P TO MB	50.ABHV5.001
N/A	RJ-11 CABLE	50.ABHV5.002
	BLUETOOTH CABLE	50.ABHV5.003
N/A	TV TUNER CABLE (TV/T-MB CABLE)	50.ABHV5.004
N/A	CABLE - 3.5 PHONE JACK TO PAL TV	50.A61V5.013
N/A	7 PIN MINI-DIN S-VIDEO TO 4 CABLE	50.A61V5.011
N/A	PAL TO NTSC CONNECTOR	20.A61V5.001
N/A	PAL-NTSC DVB-T ANT	50.A61V5.014
N/A	LCD WIRESET-15.4 IN.	50.ABHV5.008
N/A	LCD WIRESET-15 IN.	50.ABHV5.007
N/A	LCD WIRESET-15.4 IN.	50.ABHV5.008
POWER CORD		
N/A	POWER CORD US 3 PIN	27.TAVV5.001
N/A	POWER CORD EU 3 PIN	27.TAVV5.002
N/A	POWER CORD AUS 3 PIN	27.TAVV5.003
N/A	POWER CORD UK 3 PIN	27.TAVV5.004
N/A	POWER CORD CHINA 3 PIN	27.TAVV5.005
N/A	POWER CORD SWISS 3 PIN	27.TAVV5.006
N/A	POWER CORD ITALIAN 3 PIN	27.TAVV5.007
N/A	POWER CORD DENMARK 3 PIN	27.TAVV5.008
N/A	POWER CORD JP 3 PIN	27.TAVV5.009
N/A	POWER CORD SOUTH AFRICA 3 PIN	27.TAVV5.010
N/A	POWER CORD KOERA 3 PIN	27.TAVV5.011
N/A	POWER CORD ISRAEL 3 PIN	27.TAVV5.012
N/A	POWER CORD INDIA 3 PIN	27.TAVV5.013
N/A	POWER CORD TWN 3 PIN	27.TAVV5.014
CASE/COVER/BRACKET ASSEMBLY		
	MIDDLE COVER AS	42.ABHV5.001

Category	Partname	Acer Part Number
	UPPER CASE AS W/O TV & MEDIA B	60.ABHV5.001
N/A	UPPER CASE AS W/O TV W/MEDIA B	60.AD WV5.001
N/A	UPPER CASE AS W/TV & MEDIA B	TBD
	LOWER CASE W/SPEAKER MIC W/OTV W/DVI & FIR&1394	60.AD WV5.002
N/A	LOWER CASE W/SPEAKER MIC W/O TV & DVI & 1394 & FIR	60.ABHV5.002
	THERMAL DOOR	42.ABHV5.002
	T/P BRACKET	33.ABHV5.001
N/A	OPTICAL BRACKET	33.ABHV5.002
	OPTICAL BEZEL GBASE - SUPER MULTI	42.ABHV5.003
N/A	OPTICAL BEZEL GBASE - DVD/CDRW	42.ABHV5.005
	HDD DOOR AS	42.ABHV5.004
	HDD BRACKET	33.ABHV5.003
	LCD COVER 15 IN. WITH LOGO W/ANTENNA	60.ABHV5.003
	LCD BEZEL W/LOGO- 15 IN.	60.ABHV5.004
	LCD BRACKET SET (R&L) - 15IN	6K.ABHV5.001

Category	Partname	Acer Part Number
N/A	LCD COVER 15.4 IN. WITH LOGO W/ANTENNA	60.ABHV5.005
N/A	LCD BEZEL - 15.4 TEXTURE	60.ABHV5.006
N/A	LCD BRACKET SET (R&L) - 15.4	6K.ABHV5.002
COMMUNICATION MODULE		
N/A	WIRELESS ANTENNA 15 IN.	50.ABHV5.005
N/A	WIRELESS ANTENNA 15.4 IN.	50.ABHV5.006
CPU/PROCESSOR		
N/A	CPU AMD TURION 64 256K+256K 1.6G TMDTL50HAX4CT	KC.TTL02.500
N/A	CPU AMD TURION 64 512K+512K 1.6G TMDTL52HAX5CT	KC.TTL02.520
N/A	CPU AMD TURION 64 512K+512K 1.8G TMDTL56HAX5CT	KC.TTL02.560
N/A	CPU AMD TURION 64 512K+512K 2.0G TMDTL60HAX5CT	KC.TTL02.600
N/A	CPU AMD SEMPRON 512K 1.6G SMS3200HAX4CM	KC.S3202.25F
N/A	CPU AMD SEMPRON 256K 1.8G SMS3400HAX3CM	KC.S3402.25F
N/A	CPU AMD SEMPRON 512K 1.8G SMS3500HAX4CM	KC.S3502.25F
COMBO DRIVE		
	DVD/CDRW 24X COMBO MODULE	6M.ABHV5.001
N/A	"DVD/CDRW COMBO 24X DRIVE LITEON SSC-2485K.GBASE,LF,EMI*2"	KO.02409.022
N/A	"DVD/CDRW COMBO 24X DRIVE PHILIPS SCB5265 ,GB,LF FW#TX13"	KO.02408.011
N/A	DVD SUPER MULTI MODULE	6M.ABHV5.002
N/A	"DVD SUPER MULTI PIONEER DVR-K16RS,BASE"	KU.00805.029
N/A	"DVD SUPER MULTI PANASONIC UJ-850B,GBASE,LF"	KU.00807.025
N/A	"DVD SUPER MULTI HLDS GMA-4082N, GBASE, LF"	KU.0080D.021
N/A	"DVD SUPER MULTI PHILIPS SDVD8821,GBASE,LF"	KU.00809.005
HDD/HARD DISK DRIVE		
	HDD PATA 40G 4200RPM SEAGATE N2.2 ST9402112A (RohS)	KH.04001.019
N/A	HDD PATA 40G 4200RPM HGST HAKONE A HTS421240H9AT00 (ROHS)	KH.04007.013
N/A	HDD PATA 40G 5400RPM WD ML40 WD400UE-22HCT0 (ROHS)	KH.04008.025
N/A	HDD PATA 60G 5400RPM SEAGATE MERRCURY2 ST96812A (RohS)	KH.06001.007
N/A	HDD PATA 60G 5400RPM TOSHIBA TAURUS MK6034GAX (Rohs)	KH.06004.007

Category	Partname	Acer Part Number
N/A	HDD PATA 60G 5400RPM HGST MORAGA+ HTS541060G9AT02 (RohS)	KH.06007.011
N/A	HDD PATA 80 5400RPM SEAGATE Merrcury 2 ST98823A (RohS)	KH.08001.022
N/A	HDD PATA 80G 5400RPM TOSHIBA Ares-B	KH.08004.006
N/A	HDD PATA 80G 5400RPM HGST MORAGA+ HTS541080G9AT00 (RohS) F/W: A60A	KH.08007.013
N/A	HDD PATA 80G 5400RPM WD ML40 WD800-22HCT0(Rohs)	KH.08008.027
N/A	HDD PATA 100G 5400RPM SEAGATE Mercury 2 ST9100824A (RohS)	KH.10001.007
N/A	HDD PATA 100G 5400RPM TOSHIBA Ares-B MK1032GAX (RohS)	KH.10004.002
N/A	HDD PATA 100G 5400RPM HGST Moraga+ HTS541010G9AT00 (RohS) FW:A60A	KH.10007.004
N/A	HDD PATA 100G 5400RPM WD ML60	KH.12001.024
N/A	HDD PATA 120G 5400RPM SEAGATE Merrcury 2 ST9120821A(RohS)	KH.12004.002
N/A	HDD PATA 120G 5400RPM TOSHIBA Taurus MK1234GAX(Rohs)	KH.1200B.001
N/A	HDD SATA 80G 5400RPM SEAGATE Mercury 2 ST98823AS	KH.08001.023
N/A	HDD SATA 80G 5400RPM TOSHIBA Aries-B MK8032GSX	KH.08004.005
N/A	HDD SATA 80G 5400RPM HGST Moraga+B HTS541080G9SA00	KH.08007.015
N/A	HDD SATA 100G 5400RPM SEAGATE Mercury 2 ST9100824AS FW:3.06	KH.10001.008
N/A	HDD SATA 100G 5400RPM TOSHIBA Aries-B MK1032GSX F/W: AS021G	KH.10004.003
N/A	HDD SATA 100G 5400RPM HGST Moraga+B HTS541010G9SA00 FW:S60D	KH.10007.005
N/A	HDD SATA 100G 5400RPM SAMSUNG M60S HM100JI	KH.1000B.003
N/A	HDD SATA 120G 5400RPM SEAGATE Mercury 2 ST9120821AS	KH.12001.025
N/A	HDD SATA 120G 5400RPM TOSHIBA Taurus MK1234GSX(Rohs)	KH.12004.003
N/A	HDD SATA 120G 5400RPM SAMSUNG M60S HM120JI	KH.1200B.002
KEYBOARD		
	KEYBOARD CHINESE W/MEDIA B AS	TBD
N/A	KEYBOARD THAILAND W/MEDIA B AS	TBD
N/A	KEYBOARD HEBREW W/MEDIA B AS	TBD
N/A	KEYBOARD ARABIAN W/MEDIA B AS	TBD
N/A	KEYBOARD US INTERNATIONAL W/MEDIA B AS	TBD
N/A	KEYBOARD RUSSIA W/MEDIA B AS	TBD
N/A	KEYBOARD GREEK W/MEDIA B AS	TBD
N/A	KEYBOARD CZECH REPUBLIC W/MEDIA B AS	TBD
N/A	KEYBOARD UK W/MEDIA B AS	TBD

Category	Partname	Acer Part Number
N/A	KEYBOARD SWEDEN W/MEDIA B AS	TBD
N/A	KEYBOARD FRENCH W/MEDIA B AS	TBD
N/A	KEYBOARD PORTUGUESE W/MEDIA B AS	TBD
N/A	KEYBOARD HOLLAND W/MEDIA B AS	TBD
N/A	KEYBOARD CROATIA W/MEDIA B AS	TBD
N/A	KEYBOARD SLOVENIA W/MEDIA B AS	TBD
N/A	KEYBOARD SLOVAK W/MEDIA B AS	TBD
N/A	KEYBOARD BRAZIL PORTUGES W/MEDIA B AS	TBD
N/A	KEYBOARD SWISS/G W/MEDIA B AS	TBD
N/A	KEYBOARD DENMARK W/MEDIA B AS	TBD
N/A	KEYBOARD ITALIAN W/MEDIA B AS	TBD
N/A	KEYBOARD BELGIUM W/MEDIA B AS	TBD
N/A	KEYBOARD GERMAN W/MEDIA B AS	TBD
N/A	KEYBOARD CANADA FRANCH W/MEDIA B AS	TBD
N/A	KEYBOARD NORWAY W/MEDIA B AS	TBD
N/A	KEYBOARD HUNGARY W/MEDIA B AS	TBD
N/A	KEYBOARD SPANISH W/MEDIA B AS	TBD
N/A	KEYBOARD LATIN W/MEDIA B AS	TBD
N/A	KEYBOARD ICELANDIC W/MEDIA B AS	TBD
N/A	KEYBOARD TURKEY W/MEDIA B AS	TBD
N/A	KEYBOARD JAPAN W/MEDIA B-AS	TBD
N/A	KEYBOARD CHINESE W/O MEDIA B AS	KB.ASP07.001
N/A	KEYBOARD THAILAND W/O MEDIA B AS	KB.ASP07.003
N/A	KEYBOARD HEBREW W/O MEDIA B AS	KB.ASP07.023
N/A	KEYBOARD ARABIAN W/O MEDIA B AS	KB.ASP07.018
N/A	KEYBOARD US INTERNATIONAL W/O MEDIA B AS	KB.ASP07.002
N/A	KEYBOARD RUSSIA W/O MEDIA B AS	KB.ASP07.014
N/A	KEYBOARD GREEK W/O MEDIA B AS	KB.ASP07.021
N/A	KEYBOARD CZECH REPUBLIC W/O MEDIA B AS	KB.ASP07.012
N/A	KEYBOARD UK W/O MEDIA B AS	KB.ASP07.005
N/A	KEYBOARD SWEDEN W/O MEDIA B AS	KB.ASP07.015
N/A	KEYBOARD FRENCH W/O MEDIA B AS	KB.ASP07.007
N/A	KEYBOARD PORTUGUESE W/O MEDIA B AS	KB.ASP07.011
N/A	KEYBOARD HOLLAND WO /MEDIA B AS	TBD
N/A	KEYBOARD CROATIA W/O MEDIA B AS	KB.ASP07.140
N/A	KEYBOARD SLOVENIA W/O MEDIA B AS	KB.ASP07.139
N/A	KEYBOARD SLOVAK W/O MEDIA B AS	TBD
N/A	KEYBOARD BRAZIL PORTUGES W/O MEDIA B AS	KB.ASP07.019
N/A	KEYBOARD SWISS/G W/O MEDIA B AS	KB.ASP07.008
N/A	KEYBOARD DENMARK W/O MEDIA B AS	KB.ASP07.017
N/A	KEYBOARD ITALIAN W/O MEDIA B AS	KB.ASP07.006
N/A	KEYBOARD BELGIUM W/O MEDIA B AS	KB.ASP07.009
N/A	KEYBOARD GERMAN W/O MEDIA B AS	KB.ASP07.004

Category	Partname	Acer Part Number
N/A	KEYBOARD CANADA FRANCH W/O MEDIA B AS	KB.ASP07.020
N/A	KEYBOARD NORWAY W/O MEDIA B AS	KB.ASP07.016
N/A	KEYBOARD HUNGARY W/O MEDIA B AS	KB.ASP07.013
N/A	KEYBOARD SPANISH W/O MEDIA B AS	KB.ASP07.010
N/A	KEYBOARD LATIN W/O MEDIA B AS	TBD
N/A	KEYBOARD ICELANDIC W/O MEDIA B AS	TBD
N/A	KEYBOARD TURKEY W/O MEDIA B AS	KB.ASP07.022
N/A	KEYBOARD JAPAN W/O MEDIA B-AS	TBD
LCD		
	ASSY LCD MODULE 15 IN. XGA W/ANTENNA	6M.ABHV5.003
	LCD 15 IN. XGA AUO B150XG02. V4 LEAD-FREE	LK.15005.010
N/A	LCD 15 IN. XGA SAMSUNG LTN150XB-L03-V	LK.15006.008
N/A	LCD 15 IN. XGA LPL LP150X08-TLA2 LF	LK.15008.019
N/A	LCD 15 IN. XGA QDI QD150XL06-03-01	LK.15009.008
N/A	LCD 15 IN. XGA CMO N150X3-L09 Rev. C1	LK.1500D.013
N/A	ASSY LCD MODULE 15.4 IN. WXGA GLARE W/ANTENNA	6M.ABHV5.004
N/A	ASSY LCD MODULE 15.4 IN. WXGA NON-CLARE W/ANTENNA	TBD
N/A	LCD 15.4 WXGA QDI QD15TL07-01 NON-GLARE LF	LK.15409.008
N/A	"LCD 15.4 IN. WXGA QDI QD15TL07-02, GLARE LF 16MS"	LK.15409.009
N/A	"LCD 15.4 WXGA SAMSUNG LTN154XA-L01-0 100 25MS L6-G5 NON-GLARE, 16MS 200 nits"	LK.15406.016
N/A	"LCD 15.4 IN. WXGA SAMSUNG LTN154XA-L01-G GLARE, 200NITS, 16MS "	LK.15406.017
N/A	LCD 15.4 IN. WXGA LPL LP154W01-TLD1 GLARE 16MS	LK.15408.018
N/A	LCD 15.4 WXGA LPL LP154W01-TLE1 TLA1 NON-GLARE 16MS 200nits V - Cut LF	LK.15408.019
N/A	LCD 15.4 IN. WXGA LPL LP154W01-TLB6 GLARE 16MS	TBD
N/A	LCD 15.4 WXGA CMO N154I2-L01 16MS NON-GLARE LF	LK.1540D.011
N/A	LCD 15.4 WXGA CMO N154I2-L02 GLARE 16MS	LK.1540D.012
N/A	LCD 15.4 IN. WXGA AUO B154EW02 V.0 16MS NON-GLARE LF	LK.15405.013
N/A	LCD 15.4 IN. WXGA AUO B154EW02 V.1 GLARE 16MS	LK.15405.014
MISCELLANEOUS		
N/A	LCD RUBBER	47.ABHV5.001
N/A	LATCH RUBBER	47.ABHV5.002
N/A	LCD SCREW MYLAR	47.ABHV5.003

Category	Partname	Acer Part Number
N/A	RUBBER FOOT - LARGE	47.ABHV5.004
N/A	RUBBER FOOT - SMALL	47.ABHV5.005
N/A	NAME PLATE - AS3100	40.ABJV5.001
N/A	NAME PLATE - AS5100	40.ABHV5.001
N/A	NAME PLATE - AS5110	40.AD WV5.001
MAINBOARD		
	MAINBOARD M52P64MB DISCRETE PATA 10/100 W/CARD READER W/O MEDIA	MB.ABJ02.001
N/A	MAINBOARD M52P128MB SATA GLAN W/CARD READER W/O TV	MB.AD W02.002
N/A	MAINBOARD M56P128MB SATA GLAN W/CARD READER W/O TV	MB.AD W02.001
N/A	MAINBOARD UMA PATA 10/100 W/CARD READER W/O TV/FIR/1394	MB.ABE02.001
PCMCIA SLOT/PC CARD SLOT		
N/A	PCMCIA SOCKET	20.ABHV5.001
MEMORY		
	MEMORY 256MB DDR II 533 NANYA NT256T64UH4A1FN-37B	KN.25603.029
N/A	MEMORY 256MB DDR II 533 MICRON MT4HTF3264HY-53EB4	KN.25604.030
N/A	MEMORY 256MB DDR II 533 SAMSUNG M470T3354CZ3-CD5	KN.2560B.017
N/A	MEMORY 256MB DDR II 533 HYNIX HYMP532S64BP6-C4	KN.2560G.012
N/A	MEMORY 512MB DDR II 533 NANYA NT512T64UH8A1FN-37B	KN.51203.023
N/A	MEMORY 512MB DDR II 533 SAMSUNG M470T6554CZ3-CD5	KN.5120B.015
N/A	MEMORY 512MB DDR II 533 HYNIX HYMP564S64BP6-C4	KN.5120G.013
N/A	MEMORY 1G DDR II 533 INFINEON HYS64T128021HDL-3.7-B (.09u)	KN.1GB02.030
N/A	MEMORY 1G DDR II 533 NANYA NT1GT64U8HA0BN-37B	KN.1GB03.006
FAN		
	FAN ASSY - DISCRETE	23.AD WV5.001
N/A	FAN ASSY - UMA	23.ABHV5.001
HEATSINK		

Category	Partname	Acer Part Number
	CPU THERMAL MODULE-DIS	60.ABHV5.009
	VGA HEATSINK-DISCRETE	34.ADWW5.001
POINTING DEVICE		
	TOUCHPAD W/SPONGE	56.ADWW5.001
SPEAKER		
	SPEAKER SET (R&L)	23.ADWW5.002
N/A	MIC	23.ADWW5.003
ACCESSORY		
N/A	REMOTE CONTROLLER - FORMASA MP-RC802	RT.8020A.001
N/A	MCE REMOTE CONTROLLER-SMK	LC.MCE05.001
N/A	MCE REMOTE CONTROLLER RECEIVER-SMK	LC.MCE05.002
N/A	MCE IR BLASTER-SMK	LC.MCE05.003
SCREW		
N/A	SCREW M2.5*3(NL)	86.ADWW5.001
N/A	SCREW M2.5*6(NL)	86.ADWW5.002
N/A	SCREW M2.5*10(NL)	86.ADWW5.003
N/A	SCREW M2.5*15(NL)	86.ADWW5.004
N/A	SCREW M2*2.2	86.ADWW5.005
N/A	SCREW M2*3-B (NL)	86.ADWW5.006
N/A	SCREW M2*3-S (NL)	86.ADWW5.007
N/A	SCREW M2*4	86.ADWW5.008
N/A	SCREW M3*4 (NL)	86.ADWW5.009
N/A	SCREW D-SUB 4#X40*1/5-NI (NL)	86.ADWW5.010

Exploded Diagram

No.	Description	Acer Part Number
001	MIDDLE COVER AS	42.ABHV5.001
002	LOWER CASE W/SPEAKER MIC W/OTV W/DVI &FIR&1394	60.ADWW5.002
004	HDD DOOR AS	42.ABHV5.004
251	MAINBOARD M52P64MB DISCRETE PATA 10/100 W/CARD READER W/O MEDIA	MB.ABJ02.001
252	SWITCH BOARD-W/TV AS	55.ADWW5.003
253	UPPER CASE AS W/O TV & MEDIA B	60.ABHV5.001
301	THERMAL DOOR	42.ABHV5.002
304	CPU THERMAL MODULE-DIS	60.ABHV5.009
305	FAN ASSY - DISCRETE	23.ADWW5.001
308	SCREW M2*3-S (NL)	86.ADWW5.007
309	SCREW M2.5*10(NL)	86.ADWW5.003
310	SCREW M2.5*15(NL)	86.ADWW5.004

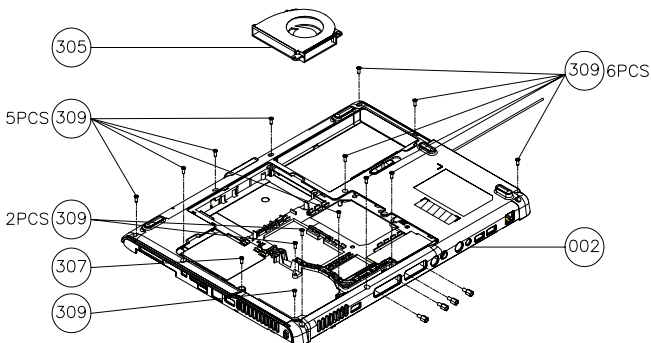
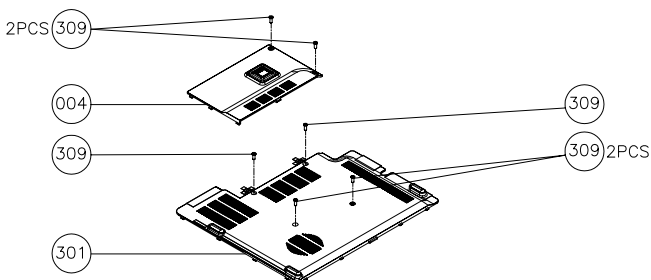
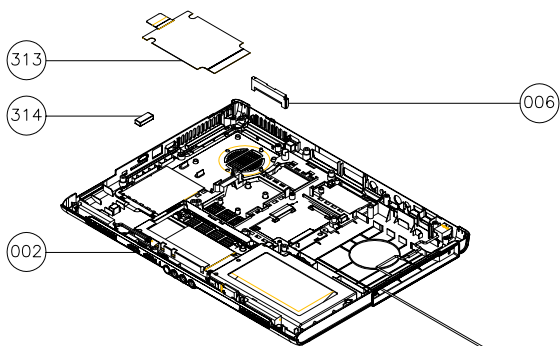
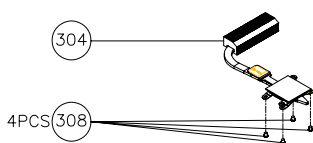
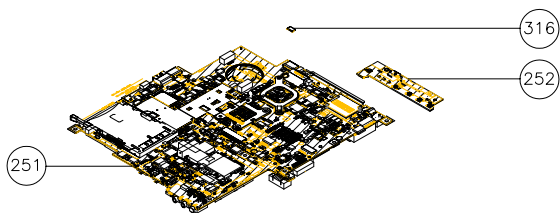
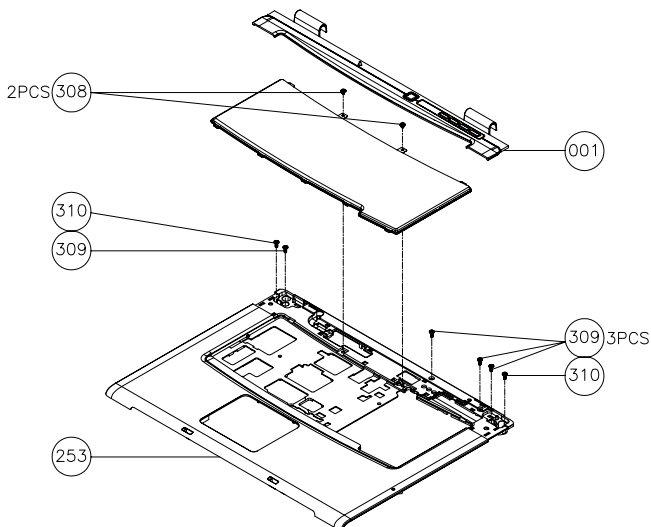

www.s-manuals.com