

workshop manual  
for the

***laura* motor **M48****

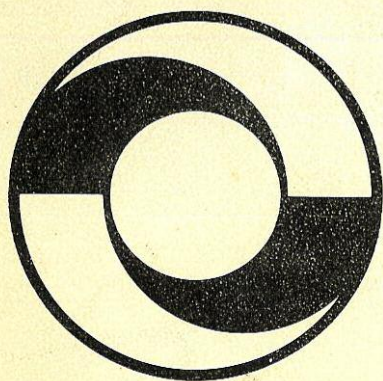



# foreword

This manual is meant in the first place to assist those, who have to maintain and repair these engines, to carry out their work in an expert and time saving manner and to make them familiar with them.

Undoubtedly some problems will arise in practice, which have not been dealt with in this manual.

In case you might not be able to overcome them, our Service Department is fully at your disposal, to assist you in every possible way.

Use only original spare parts.

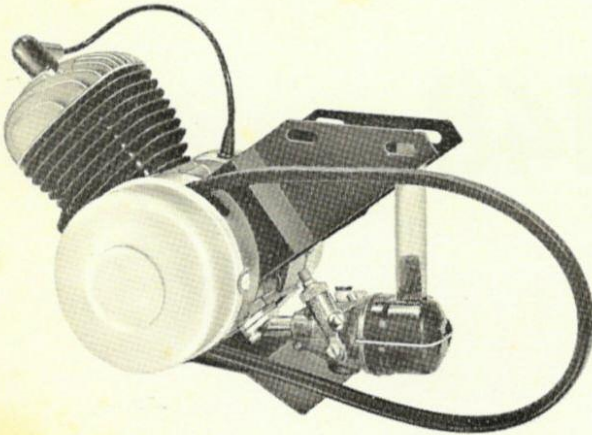

Engine M48  
clutch side

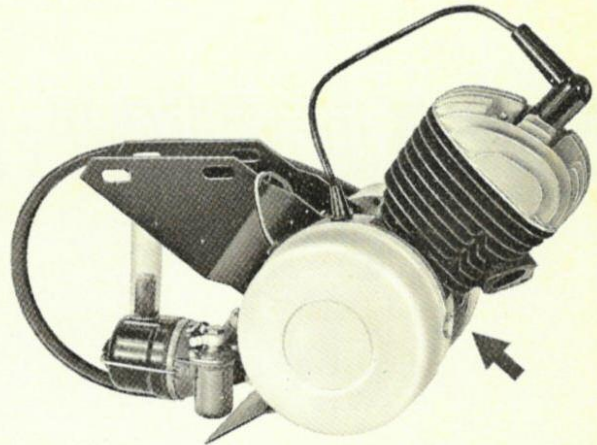

Engine M48  
magneto side, arrow indicates location of engine number

## contents

<b>technical data</b> . . . . .	<b>3</b>	<b>bicycle part</b>	
<b>engine part</b> . . . . .	<b>4</b>	12. adjusting V-belt . . . . .	<b>11</b>
<b>adjustment of:</b>		13. replacing V-belt . . . . .	<b>11</b>
1. starting cable . . . . .	<b>4</b>	14. replacing sprocket . . . . .	<b>11</b>
2. carburetter . . . . .	<b>4</b>	15. pulley . . . . .	<b>11</b>
3. breaker points . . . . .	<b>4</b>	<b>external dimensions</b> . . . . .	<b>12</b>
<b>inspection:</b>		<b>special tools</b> . . . . .	<b>13</b>
4. engine inspection system . . . . .	<b>5</b>	<b>self made tools</b> . . . . .	<b>13</b>
<b>dismantling and rebuilding:</b>		<b>wiring</b> . . . . .	<b>14</b>
5. carburetter . . . . .	<b>5</b>	<b>trouble shooting</b> . . . . .	<b>14</b>
6. ignition . . . . .	<b>5</b>	<b>exploded view</b> . . . . .	<b>16</b>
7. clutch plates . . . . .	<b>7</b>		
8. complete clutch . . . . .	<b>7</b>		
9. cylinder and head . . . . .	<b>7</b>		
10. piston . . . . .	<b>9</b>		
11. crank case and crankshaft . . . . .	<b>9</b>		



## technical data

<b>type of engine</b>	single cylinder two-stroke with reversed scavenging and membrane inlet
<b>bore × stroke</b>	40 × 38 mm
<b>cubic capacity</b>	47,78 cm <sup>3</sup>
<b>compression ratio</b>	7 : 1
<b>output</b>	1,7 hp at 5000 r.p.m.
<b>torque</b>	0,3 mkg at 3000 r.p.m.
<b>cylinder</b>	special cast iron
<b>cylinder base gasket</b>	graphited klingerit, thickness 0,5 mm
<b>cylinder head</b>	light alloy, no gasket
<b>inlet gasket</b>	graphited klingerit, thickness 0,4 mm
<b>crank case gasket</b>	paper, thickness 0,4 mm
<b>gas &amp; oil seals</b>	crankshaft slutch side: 21 × 42 × 7 mm crankshaft magneto side: 15 × 30 × 7 mm clutch: 15 × 21 × 4 mm
<b>piston</b>	special piston; oversizes: 40,25 and 40,50 mm
<b>piston rings</b>	2 piston rings; stepped gap; oversizes: 40,25 and 40,50 mm
<b>gudgeon pin</b>	floating
<b>gudgeon pin bearing</b>	special bronze
<b>crankshaft</b>	built-up type, carried by a ball bearing on each side
<b>ignition</b>	Bosch type 0/212/112/053, rotation clock-wise; lighting coli 6 V-17 W; breaker gap 0,35-0,45 mm; advance 1,8-2,2 mm before TDC; rupture distance 7-11 mm
<b>carbureateur</b>	type A11: automatic choke type S 8: manuel choke
<b>bearings</b>	crankshaft: ball bearings conecting rod: big end: needle cage, flanked by steel washers; axial clearance 0,1-0,2 mm clutch: needle bearing large pulley: two needle bearings with seal on both sides
<b>large pulley</b>	12 teeth
<b>V-belt</b>	A profile



# engine

## 1. adjustment of starting cable

Due to the running in of various components, it will prove necessary to re-adjust the starting cable after some time. Proceed as follows:

- remove LH engine cover. In case of a metal cover the easiest way is to turn cover, thus disconnecting clips from cams on crank case
- undo cable pinch screw in handle a few turns
- pull inner cable through handle until distance between arrows in fig. 1 is approx. 0.5-1 mm.
- tighten pinch screw again.

**important:** it is advisable to check whether unloaded starter spring stands 1½-2 mm or a little more free from the bronze thrust piece. If this is not the case the spring should be bent in such a way that the required distance is obtained. Hold with short end in vise. This operation not only prevents unnecessary tension on the cable, but also lightens the pulling of the handle.

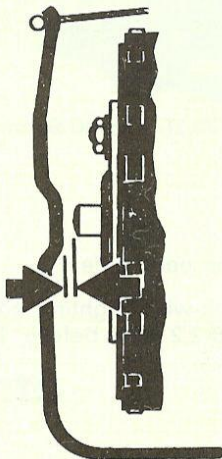

fig. 1

## 2. adjustment of carburetter

Two types of carburetter are used: the S-types which have a butterfly valve for starting and the A-type, which have an automatic choking device.

### S-types

- the cable which operates the butterfly valve must have a free travel of 1-2 mm, to be measured at the handle on the handle bar. In case of complaints about violent four-stroking and/or high fuel consumption, always check whether butterfly valve leaves bore completely free and does not obstruct the bore partially
- idling is regulated by means of spring loaded screw near the jet holder and can be reached via one of the holes in the large pulley (fig. 2)

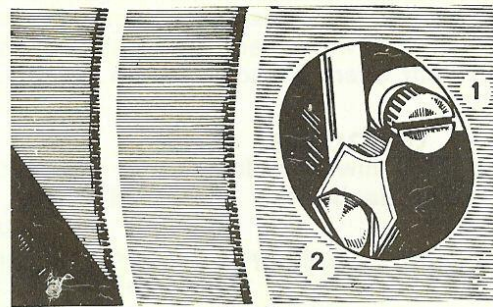

fig. 2

1. idling screw 2. jet holder

- excessive slackness in the cable can be cured by using the adjuster screws on carburetter and/or twist grip.

### A-type

As the operation of the automatic choke and the setting of the idling speed is done by the same cable, the throttle cable should be adjusted carefully.

- push choke button on twist grip forward and turn grip outward as far as possible
- in this position the throttle valve should be right at the bottom of the mixing chamber (fig. 2a). Now the cable must have a free travel of approx. 1-2 mm. This can be obtained by using the cable adjuster on the twist grip
- regulate idling speed when engine is thoroughly hot by means of the adjuster nipple on the twist grip. It will be clear that when doing this, the twist grip should not be in the starting position.

**important:** if idling speed is set when engine is cold, it will be too high when engine is hot, causing the moped to ride when stationary. This inflicts unnecessary wear on the clutch plates.

## 3. adjustment of breaker points

The flywheel magneto is located on the RH side of the engine and rotates in clock-wise direction. To get at it, remove RH crank case cover.

To be able to set the breaker gap, flywheel should be placed in the position illustrated in fig. 3 in order



to bring the points as far apart as possible. Now proceed as follows:

- slacken fixing screw half a turn
- insert a screw driver blade between notches N on base plate and opening G in fixed contact
- twisting the screw driver will alter the gap
- after obtaining the correct gap, tighten screw S and check gap again. Gap should be 0.35-0.45 mm.
- after loosening its 3 fixing screws the base plate can be turned to advance (= anti-clockwise) or retard (= clockwise) the ignition. The correct advance is 1,8-2,2 mm before TDC.

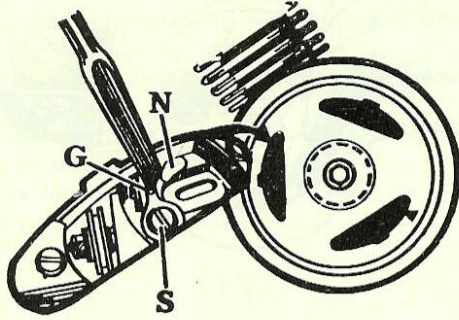

fig. 3

#### 4. engine inspection system

In case of complaints about loss of power, difficult starting or poor idling it is important to check whether this is caused by a faulty gas & oil seal, worn or stuck piston rings or a defective gasket. This can be carried out in a very simple manner:

- take carburettor from induction pipe
- fit a piece of rubber tubing (inner  $\varnothing$  16 mm) over induction pipe
- take out spark plug
- place piston in TDC
- remove both engine covers
- with smoke, blow into the tube, closing spark plug hole with a finger.

If smoke is visible from behind clutch or magneto, this indicates a defective gas & oil seal.

In case a fair amount of smoke pours from open spark plug hole (finger away), this means that there is a leak along the piston, either caused by worn or stuck rings, or a worn piston.

#### 5. dismantling and rebuilding of the carburettor

The induction pipe is fitted to the crank case by means of 2 M6 nuts (SW 10). Between pipe and casting the membrane is located with a graphited gasket on each side.

It is advisable not to dismantle these parts without reason, as the carburettor is easy to remove after undoing its pinch screw.

- first of all remove carburettor shield: unscrew both LH bolts a few turns and remove RH bolt completely. Now shield can be pulled from underneath both LH bolts
- remove intake muffler and pull carburettor from

- pipe, after undoing pinch screw a few turns
- while unscrewing mixing chamber top from carburettor on the A-type, twist grip should be placed in the starting position
- disconnect choke cable, after unhooking spring from butterfly valve (S-types only)
- clean carburettor externally before taking it apart
- check all parts and pay particular attention to:
  - a. dirt in float needle guide on bottom of float chamber. Clean hole using a drill of 1.2 mm
  - b. presence and cleanliness of the small filter in the banjo bolt
  - c. damage and wear of float needle point and float (use magnifying glass)
  - d. correct throttle valve
  - e. correct size of jet

During assembly make sure, that pointed end of needle is up and float can be moved freely (shake). After fitting carburettor to pipe check whether it is absolutely vertical and pushed as far as it will go.

**important:** it can happen, that bad idling can be improved by tilting the carburettor slightly.

On the other hand a sudden carburation fault might be caused by so doing.

After having finally fitted the intake muffler, be sure that plastic tube is not pinched or blocked in any other way.

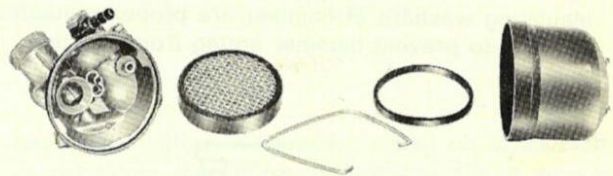
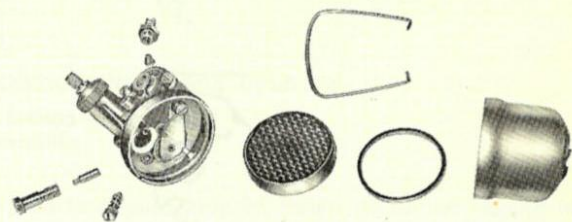

fig. 4  
A-type with automatic choke



S-type with manual choke

#### 6. ignition

##### dismantling

- undo flywheel nut (SW 14) using a thin-walled socket or box spanner, at the same time holding flywheel with the special tool (nr. 3 on page 13)



- using the extractor (nr. 5 on page 13) which is screwed into the flywheel as far as possible to prevent shearing of the thread, the flywheel is pulled from the crankshaft

- disconnect plug cover from HT lead, apply a spot of oil on lead where it enters the grommet and pull cable through

**attention:** never pull on lead by means of the HT coil!

- disconnect yellow and black wire from terminal block (remove RH valve, if any) and pull both wires through their grommet in the same way as the HT lead

- unscrew the 3 screws holding the stator plate, after which the latter can be taken from the casting.

### inspection

- check HT coil on test bench. Maximum spark gap 8 mm in order to avoid damaging a good coil

- test condenser. To do this properly, the soldered connection to the HT coil must be separated. Removing and fitting the condenser is done from rear side of stator plate, using a properly fitting dolly with a diameter of 12 mm. When soldering, the iron must be well heated, as too long a procedure will make the condenser useless

- replace breaker points in case they are badly burned and pitted and cannot be reconditioned with the use of a file. Clean contact surfaces well and make sure they mate properly, as illustrated in fig. 6. This can be obtained by bending the fixed contact using a pair of pliers. Apply one drop of oil to hammer spindle and lubricating wick and check whether insulating washers of hammer are properly situated in order to prevent hammer spring from shorting.

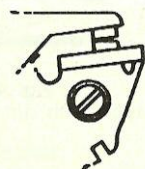

wrong

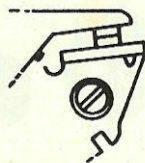

correct

fig. 6

### rebuilding

- when fitting stator plate, make sure it rests properly inside the locating spigot and no wires are pinched between plate and casting

- fit the 3 screws but do not tighten them fully yet

- when replacing flywheel, place crankshaft in such a position, that key is opposite condenser in order to

let cam pass breaker hammer freely

- in case a new coil is fitted, use a feeler gauge of 0.2 mm to check the air gap between inner rim of flywheel and core shoes (fig. 7). Correction is carried out by moving coil in the manner shown in fig. 8, during which the screws should not be fully tightened

**attention:** never place dolly against the shoes but against the core itself

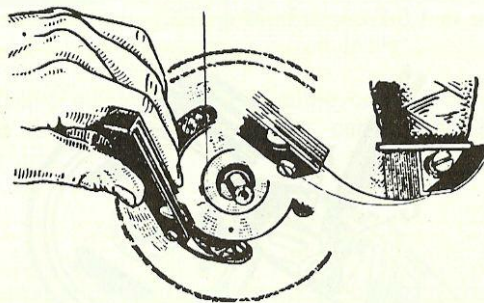

fig. 7

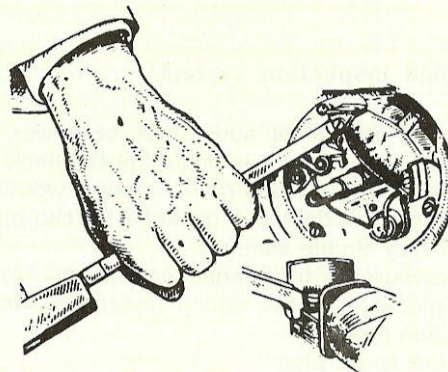

fig. 8

- adjust gap of the breaker points (0.35-0.45 mm)

- place piston in T.D.C.-position

- Turn the flywheel anti-clockwise. The moment the breakerpoints open, the rupture distance between a magnet and the core shoe (A in fig. 9) must be 7-11 mm and the advance 1,8-2,2 mm.

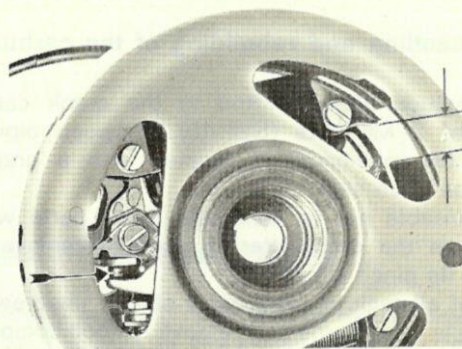

fig. 9



The distance A can be adjusted by changing the breakerpoint-gap, the advance by turning the magneto base-plate.

## 7. replacing friction plate

Replacing the friction plate is carried out as follows:

- take off LH engine cover and unhook starting cable from the leaf spring
- remove leaf spring by undoing both bolts (SW 8) on underside of casting
- successively unscrew the 6 nuts (SW 8) and take off their undulated washers.
- remove locking plate and end plate, after which the friction plate can be taken out.

Before fitting a new friction plate, first of all check whether it has the correct thickness of 3.8 mm and whether plate will slide smoothly in slots of housing without sticking anywhere. If not the high spots must be removed with a file.

Fit central spring with widest end facing engine

## 8. dismantling and rebuilding complete clutch

### dismantling

Start as described in para. 7 and continue as follows:

- remove Vee-belt by slackening both fixing bolts in frame (SW 13), after which engine can be pushed backwards
- flatten tab washer under central nut and remove nut (SW 17) and washer. While undoing nut, hold hub using special tool (nr. 4 on page 13). Fig. 10.

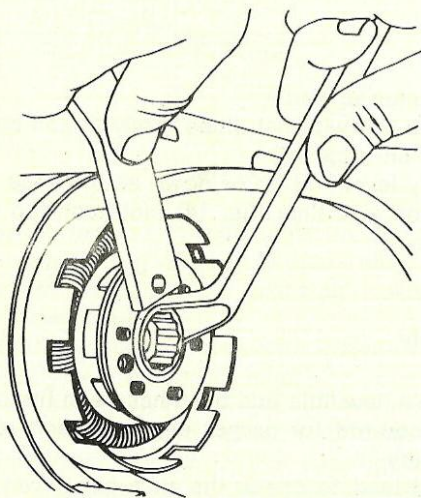

fig. 10

- pull hub from crankshaft together with everything left on it. In case this cannot be done with bare hands, use handle of hub retaining tool as an extractor
- behind hub a saucer spring is fitted. Pay attention to the way it is fitted. In case of replacement, always use the correct thickness (1 mm)!
- with a twisting movement pull housing from crankshaft.

### inspection

- thoroughly clean bearing in housing and apply some fresh oil
- important:** when replacing the needle bearing always bear in mind, that the **pressure must be applied on the marked end** of the cage. If not, the bearing will be ruined
- always replace oil seal in housing in case of doubt about its condition
- prise out clutch spring and check whether its ends are properly (at least 4 treads) connected
- if it turns out, that Vee-belt has touched bottom of small pulley, either the belt is worn out, or an incorrect type has been used.

### rebuilding

Rebuild clutch in the reversed order of dismantling. Take good care that saucer spring is fitted with its upturned end facing outward.

- see para. 7 for further instructions

- important:** before replacing housing on crankshaft, insert fitting sleeve (nr. 8 on page 13) in seal to prevent damaging or fouling the sealing edge
- always fit new undulated washers

## 9. cylinder head and cylinder

### dismantling

These parts should only be taken off, when engine is completely cooled off. When removing the cylinder, first of all clean circumference of cylinder base with a brush and petrol and disconnect exhaust pipe from cylinder as well as clamp of silencer.

- after having removed the 4 nuts (SW 10 box spanner), spring washers and plain washers, lift off cylinder head. There is no gasket
- carefully lift cylinder vertically from studs and wrap a non-fluffy rag around the connecting rod to prevent dirt from reaching the crankshaft
- during decarbonising the cylinder and the cylinder



head be careful not to scratch the jointing surfaces nor to burr the various ports

- protect cylinder bore with a rag by decarbonising the cylinder-exhaust port as shown in fig. 11.
- Remove possible burrs with a piece of fine emery cloth, soaked in paraffin or oil
- do not forget to decarbonise the exhaust pipe and silencer as well.

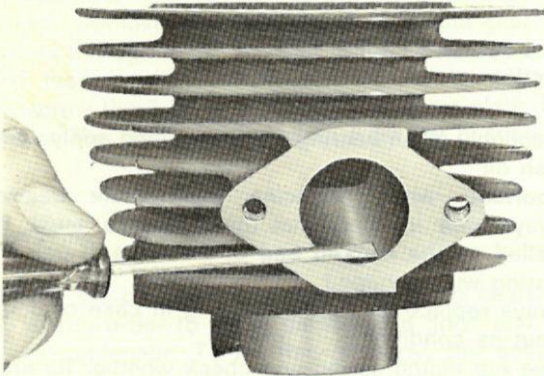

fig. 11

#### inspection

- remove both piston rings (note their respective positions) and check for excessive wear by placing them in the bottom end of the bore (fig. 12). Minimum gap 0.2 mm, maximum gap 0.5 mm.

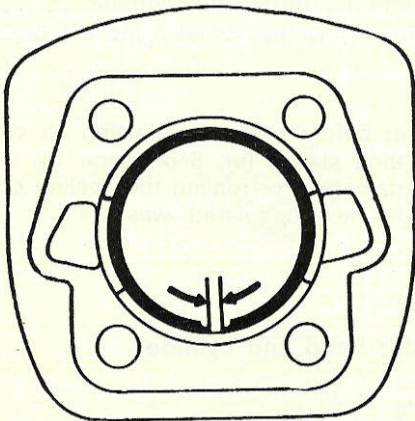

fig. 12

- scrape inner side of ring to remove carbon deposit, but only clean grooves in case new rings are to be fitted
- always check connecting rod for alignment. An untrue con-rod causes a faulty „running face” of the piston. For instance one side of piston is highly polished at RH top and the other side at LH bottom, while the rest of piston is coated brown
- take off both piston rings
- fit cylinder over studs

- fit cylinder properly on casting by using 2 distance bushes on diagonal studs (fig. 13)

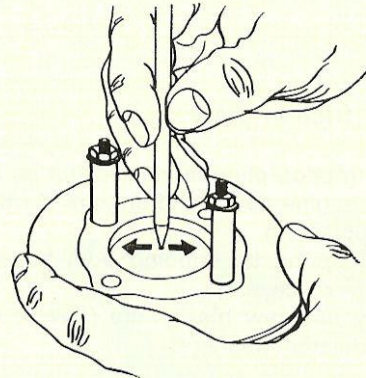

fig. 13

- using a pointed pin check whether piston does not rub on one side of cylinder only. If this is the case, re-alignment of con-rod is required. This is carried out as follows:
- insert through gudgeon pin a round bit of steel (perfectly round and straight) of a diameter of 8 mm and not longer than 20 cm

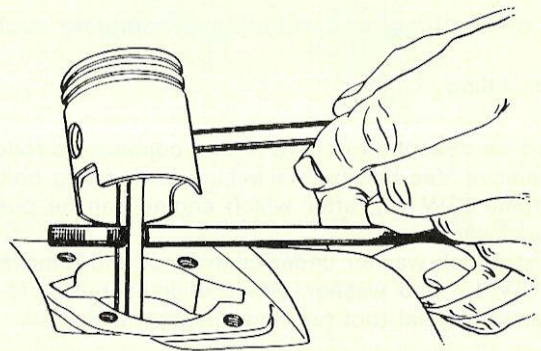

fig. 14

- draw piston upwards
- hold con-rod with flat sides firmly in self-made tool (fig. 26 on page 13)
- carefully lever rod up or down as the case may be, a fraction at a time (fig. 14), until con-rod angle is correct.

#### reassembly

- in case a new little end bush has been fitted, **always check con-rod** for proper alignment and re-align if necessary
- it is advised to check the ring gap, even on new rings, as shown in fig. 12



- before fitting cylinder barrel, true up jointing surface for cylinder head on a piece of fine emery cloth and surface plate or thick glass (fig. 15)

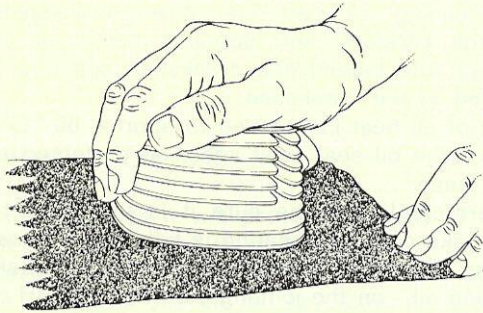

fig. 15

- use a new base gasket and stick this with a little grease to the base surface. Be sure that no rests of the old gasket are still present
- support piston using a forked piece of wood (nr. 27 on page 13) as illustrated in fig. 16, which greatly facilitates the fitting of the cylinder and apply oil lavishly on piston and in barrel
- fit barrel and be sure that locating pegs in piston are indeed inside ring gap (fig. 16)

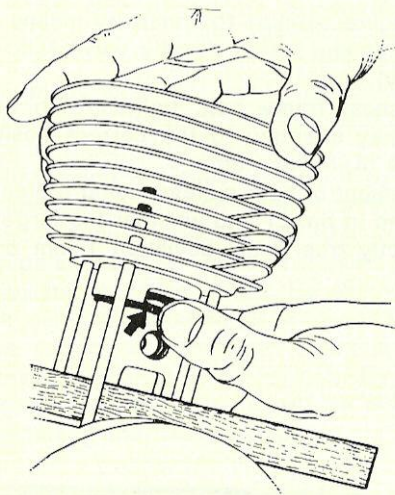

fig. 16

- true up surface of cylinder head in the same way as the cylinder (fig. 17) and fit spark plug. The latter to prevent washers from dropping inside cylinder and/or crankcase
- wipe both jointing surfaces with a clean rag, smear face lightly with oil and fit head
- replace successively 4 plain washers, spring washers and nuts, and tighten nuts diagonally and, most important, evenly. Do not over-tighten nuts as this will cause failure of the studs and deformation of cylinder barrel.

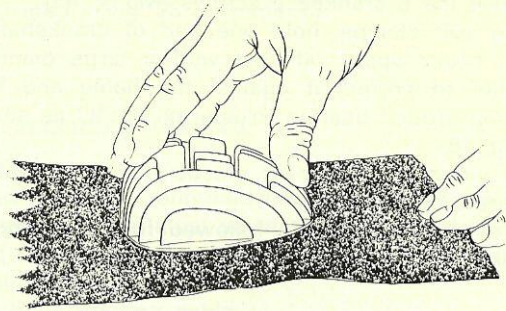

fig. 17

## 10. piston

If piston has to be removed, its crown should be marked on the exhaust side, in case it has not been marked beforehand.

After taking out both circlips, the gudgeon pin can be pushed by hand from the piston, as it has a push-fit. Always check whether pin has not too much clearance in its bronze bush before replacing piston. In case of doubt renew gudgeon pin bush.

After fitting piston it must be checked for true alignment, as described on page 8.

**important:** do not take any risks and always use new circlips for the gudgeon pin after removing the latter.

## 11. crank case and crankshaft

### dismantling

To do this, the engine has to be separated from the frame. After removing clutch and ignition, the engine support bracket can be disconnected (4 bolts SW 12). In those cases where both side plates are not welded together by means of a strip, they can be left untouched, if desired.

- prise out both rubber grommets from casting
- dismantle successively cylinder head, cylinder, piston (not strictly necessary), induction pipe, membrane and their respective gaskets. Be careful not to damage the membrane: put it aside with pointed edge up

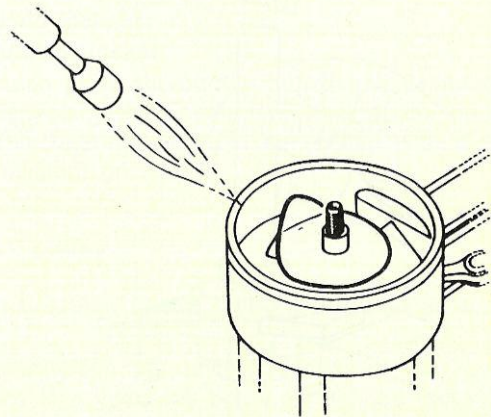

fig. 18



- remove the 6 crankcase screws (M5 × 45)
- using soft clamps, hold one end of crankshaft in vise, cover upper oil seal with a large diameter washer to protect it against the flame and heat casting around bearing to approx. 80 °C as shown in fig. 18
- with aid of a rubber or plastic hammer carefully separate both castings
- the same procedure is followed for other end of crankshaft.

### inspection

- check whether bearings of crankshaft and connecting rod are in perfect order
- closely inspect both gas & oil seals for failure
- remove (if necessary) both ball bearings, using special tool (nr. 1 on page 13) and adapter (nr. 9 on page 13), as illustrated in fig. 19. Both bearings are of the 6302 type, having an external diameter of 42 mm.

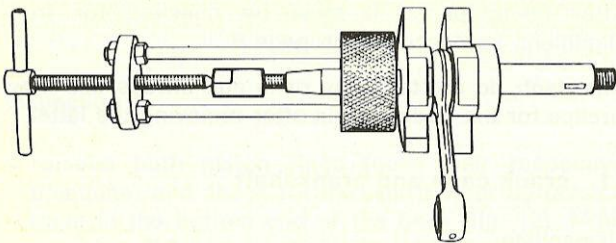

fig. 19

A worn big-end bearing can only be replaced at the works, where an exchange crankshaft will be supplied.

### rebuilding

In cases where the main bearings have been removed, they must be re-fitted beforehand.

- heat bearing to approx. 80 °C in tin with oil

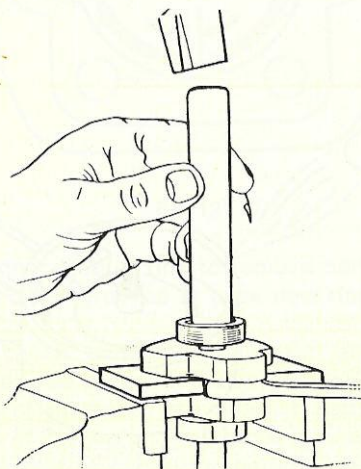

fig. 20

- place one web of crankshaft on fitting plate (nr. 10 on page 13) on vice and fit, bearing, using dolly (nr. 2 on page 13) on inner ring of bearing, as illustrated in fig. 20.

After having cleaned crankcase, crankshaft and bearings carefully and applying some oil on ball bearings and bigend, the crankshaft can now be re-installed in the crankcase.

- first of all heat LH casting to approx. 80 °C during which the oil seal must again be protected against the flame
- insert crankshaft (be sure it is the correct end!) and take care that bearing is fully home in casting
- place a new gasket - which must be soaked in engine oil - on the jointing surface, heat RH casting in the same way as the LH one and fit it gently but quickly
- tighten the 6 screws
- with a plastic hammer apply a couple of short taps on the casting around both bearings to settle crankshaft and check whether crankshaft can be turned lightly by hand
- cut off protruding pieces of the gasket with a sharp knife on membrane and cylinder surfaces
- fit successively: piston, cylinder, cylinder head, membrane, induction pipe (shut it off with a cork), engine support bracket, ignition and clutch
- set the ignition as described before
- fit carburetter, starter leaf spring and carburetter shield
- connect engine support to frame by means of the rearmost bolt and install throttle valve (and choke cable if any)
- insert foremost frame bolt, tighten both nuts by hand and pay attention to the correct position of plastic tube of intake muffler
- check alignment of both pulleys, using a steel ruler, as illustrated in fig. 21 and whether the large pulley runs perfectly true (max. deviation 1 mm on each side).

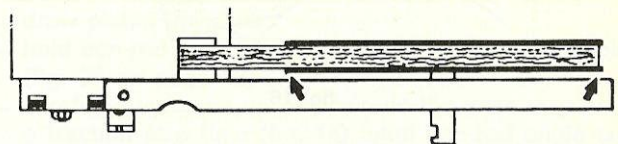

fig. 21

Mis-alignment can be cured either by trueing up the engine support bracket or by removing or adding one (and just one) spacer washer **behind** the large pulley. To compensate this, a spacer washer must be added, or removed respectively on the **outside** of the pulley, in order to create the correct end play of the pulley.



## bicycle

### 12. adjusting Vee-belt

On a new machine it will prove necessary to adjust the belt after the initial 75 or 100 miles.

The correct tension is obtained, when belt can be depressed approx. 0.5 cm on one side, as shown in fig. 22.

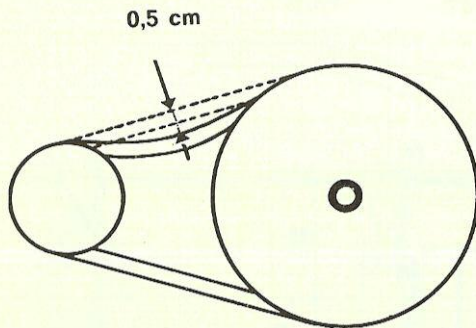

fig. 22

Bear in mind, that too much tension not only will cause premature wear of belt but also overloads the bearings of clutch and large pulley.

Too little tension will cause belt to slip.

To tension belt, both bolts which connect engine to frame should be slackened and the connection exhaust pipe/silencer (or silencer/frame), whatever the case may be) must be eased. By sliding the engine, the belt can be tightened or slackened. To do this, insert a rod of  $\varnothing$  5 mm into holes A (fig. 23 and place lever B against foremost bolt. By pulling lever in direction of arrow, engine will be moved forward, thus tightening the belt (fig. 23).

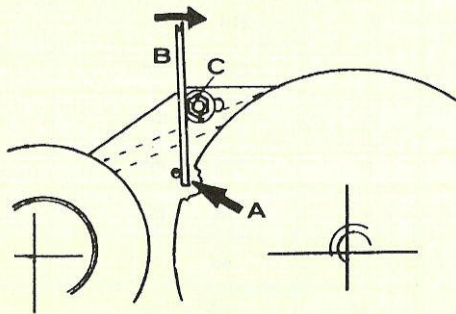

fig. 23

You can work fast and easy when you make a tool as illustrated in fig. 28 on page 13.

### 13. replacing Vee-belt

Apart from the mentioned connections in para 12, the LH engine cover must be removed. A metal cover can best be twisted to free both clips from cams on casting.

- unhook starting cable
- remove starter leaf spring and its support plate (2 bolts SW 10 underneath casting)
- start taking off Vee-belt at the large pulley and finish by taking it off the clutch pulley.

Re-fitting is carried out in the reversed order.

When fitting a metal clutch cover, always hook flat clip first, together with the cover and lastly hook larger clip.

#### attention

The next 3 paragraphs cover:

hub of large pulley (14)

large pulley (15)

pedal axle (16).

Because these 3 parts - of which some variations exist - are very closely connected, due to the needle bearing, it is advisable to stock one complete hub with axle of each combination to be sure to meet any demand for replacement.

As soon as a set (or part of it) is used, an identical part should be ordered.

### 14. replacing drive sprocket

In case of a worn sprocket, it must be replaced to prevent undue wear of the chain. This is carried out as follows:

- disconnect chain at connecting link, slacken Vee-belt and remove belt (start at large pulley)
- take off LH crank, distance bush with thrust washer(s) and pulley
- undo locknut.
- undo sprocket
- clean parts thoroughly before reassembling. Especially the needle-bearings off the pulley. This bearings have to be refilled with a corrosion resistant grease.

### 15. pulley

The bearings of the pulley are sealed on both sides.

Nevertheless the pulley has to be demounted two times in a year, the bearings cleaned thoroughly and refilled with a corrosion-resistant grease.



# external dimensions

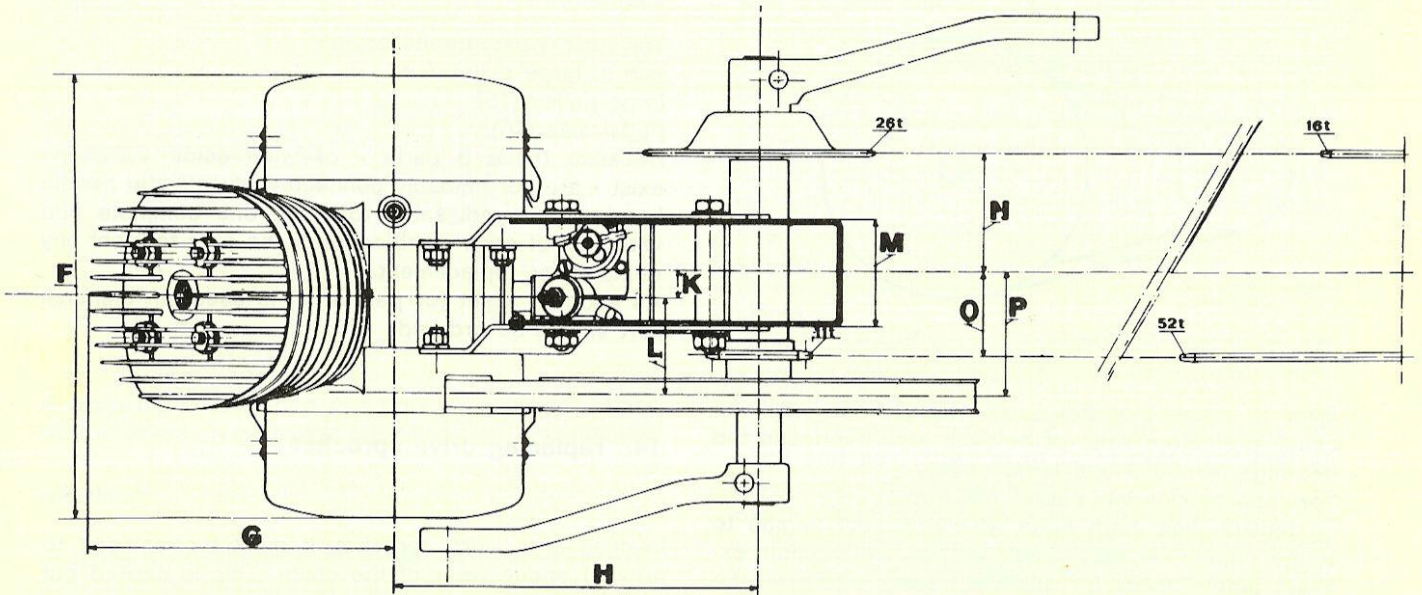
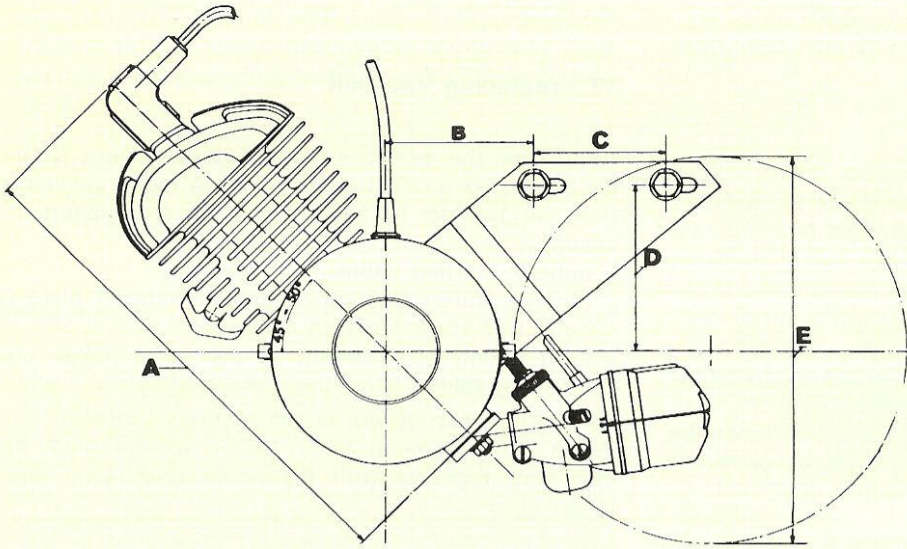

A	275	mm
B	80	mm
C	70	mm
D	90	mm
E	210	mm
F	210	mm
G	145	mm
H	175	mm
K	13	mm
L	46	mm
M	50	mm
N	56	mm
O	40	mm

Approximate dimensions



## special tools

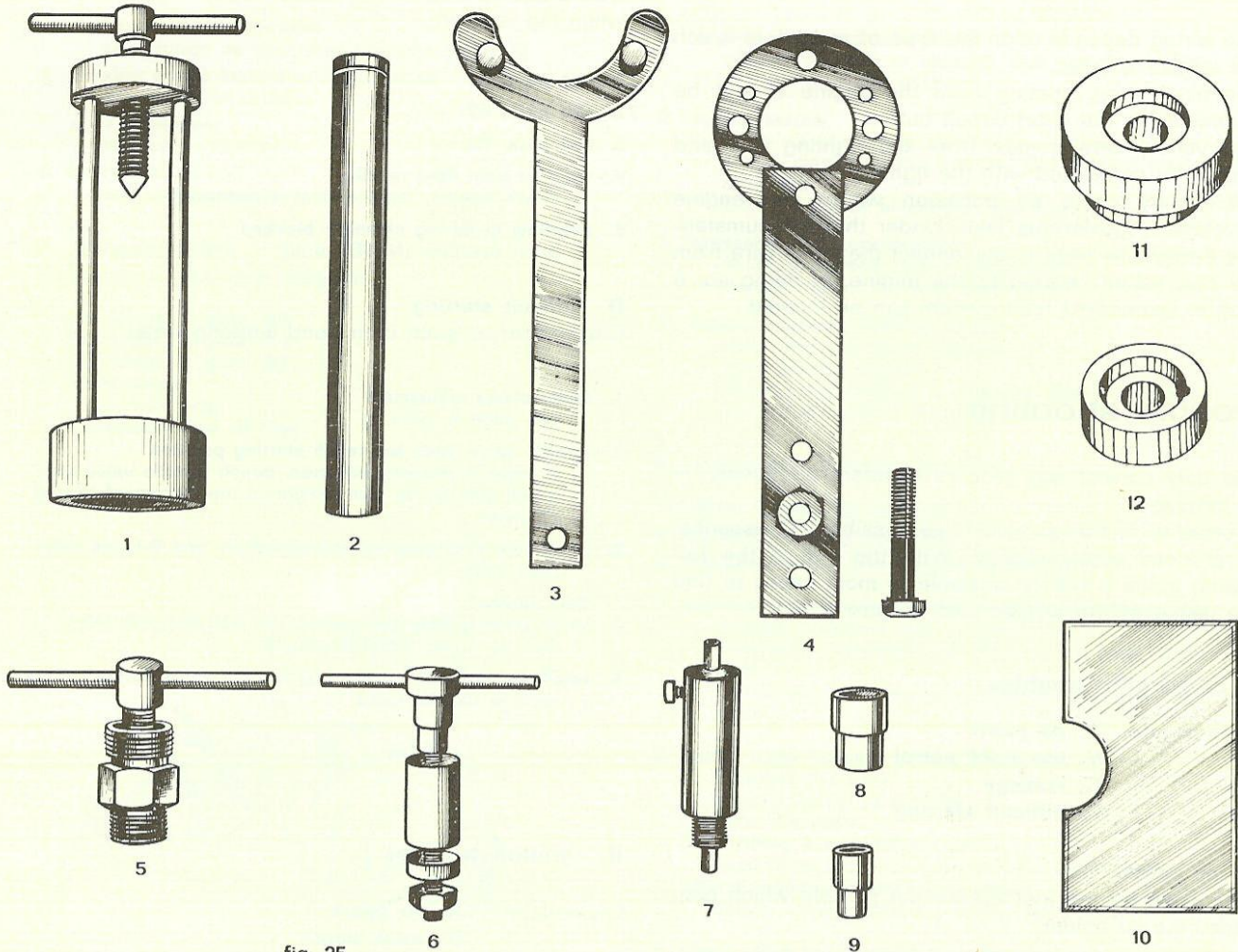

fig. 25

## special tools

nr.	description
1	extractor for crankshaft bearings
2	dolly for fitting crankshaft bearings
3	flywheel steady
4	combined steady and puller for clutch hob
5	flywheel extractor
6	press for little end bush
7	ignition timing tool
8	fitting sleeve for clutch oil seal
9	adapter M10 for crankshaft
10	support plate for crankshaft bearings
11	Fitting tool for oil seal
12	Fitting tool for oil seal.

## self made tools (all sizes in millimetres)

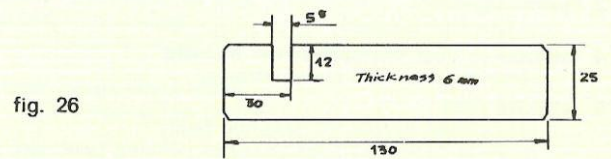

fig. 26

connecting rod aligning tool



fig. 27

wooden fork to support piston when fitting cylinder

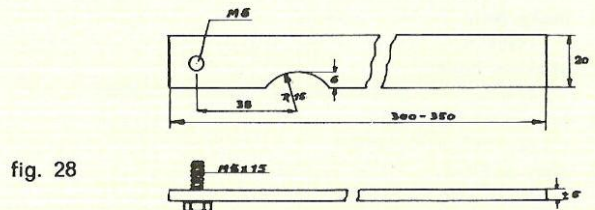

fig. 28

special lever to tighten Vee-belt



## wiring

The wiring depends upon the type of moped, in which the engine is used.

The black wire, coming from the engine should be connected to the short-circuit button.

The yellow wire comes from the lighting coil and should be connected with the lighting switch.

There may come an occasion where the engine develops a mysterious fault. Under these circumstances it might be wise to disconnect the black wire from the connection nearest to the engine. In doing so, a fault in the short-circuit system can be located.

## trouble shooting

The only correct way to cure a defect effectively, is to localize it.

In order to do this as quickly as possible it is essential to proceed systematically. With the aid of the following guide it will be possible in most cases to find the cause of the trouble and to cure it.

### I. carburettor troubles

Divided into: **A. no petrol**  
**B. too much petrol**  
**C. leakage**  
**D. difficult starting**

#### A. no petrol

With open tap no fuel comes out of hole which contained the jet holder.

- 1. air vent in filler cap blocked**  
check air vent, enlarge vent if necessary
- 2. petrol tap blocked**  
strainer or passages blocked  
displaced cork washer in tap
- 3. petrol pipe**  
pinched or blocked
- 4. strainer in float chamber cover blocked**  
remove union and check strainer
- 5. sticking float**  
check float needle for possible faults  
guide in bottom of float chamber polluted (see pag. 5, para. a)
- 6. dirt inside jet holder and/or atomiser**  
this only occurs, when polluted fuel has been used

#### B. too much petrol

Engine runs 4-stroke, excessive smoke from exhaust.

- 1. wrong type of float or jet**  
see spares list
- 2. leaky float**  
replace
- 3. sticking float**  
check float and guide for possible faults
- 4. jet out of jetholder**  
jet lost or forgotten
- 5. dirty airfilter**  
rinse and oil lightly
- 6. butterfly valve does not return fully (S-types only)**  
cable unsuitable or spring too weak or out of order

#### C. leakage

Carburettor floods or fuel leaks from mixing chamber when tap is open.

- 1. see para. B1**
- 2. see para. B2**
- 3. see para. B3**
- 4. worn or bent float needle**  
check needle, replace float if necessary
- 5. overflow in mixing chamber blocked**  
prick overflow (NEVER drill)

#### D. difficult starting

Carburettor as such is in good working order.

- 1. faulty choke adjustment**  
see page 4, para. 2
- 2. throttle valve does not reach starting position**  
if cable is properly adjusted, polish throttle valve until it will sink by its own weight to the bottom of mixing chamber
- 3. small hole in throttle valve blocked (A- and B-types only)**  
prick hole  
**Very rarely:**
- 4. small starting hole too narrow (A- and B-types only)**  
drill to 1 mm (NEVER larger)
- 5. small starting hole covered by throttle valve spring**  
replace throttle valve

### II. ignition troubles

Divided into: **A. no spark**  
**B. weak spark**  
**C. irregular spark**

#### A. no spark

Check as shown in fig. 29. Distance between arrows about 3 à 4 mm.

- 1. faulty connection between HT lead in plug cover or at HT coil**  
cut off a little piece of HT lead and connect lead again
- 2. HT lead fractured or insulation damaged**  
check lead, replace if necessary
- 3. breaker points do not open**  
adjust points, replace if necessary
- 4. loose connection in base plate**  
check connections, re-solder if necessary
- 5. breaker hammer spring broken**  
replace hammer
- 6. hammer spring connection shorts to earth**  
replace insulating washers
- 7. short circuit button makes earth connection**  
first disconnect black wire from terminal block. If still no spark, check black wire leading to condenser
- 8. short in lighting switch**  
check connections following diagram
- 9. short or faulty connection in head lamp**  
check connections following diagram
- 10. faulty HT coil**  
test coil, replace in case of doubt



### B. weak spark

Check as shown in fig. 29

1. **rupture distance incorrect**  
set ignition as described on page 6 (fig. 9)
2. **breaker points burned or badly pitted**  
file points or replace
3. **poor condenser**  
replace condenser
4. **faulty ignition coil**  
test coil or replace

### C. irregular spark

Engine runs, but very irregular

1. see chapt. 2, para. A2
2. see chapt. 2, para. A4
3. see chapt. 2, para. A7
4. **faulty plug**  
replace plug
5. **insufficient flow of fuel**

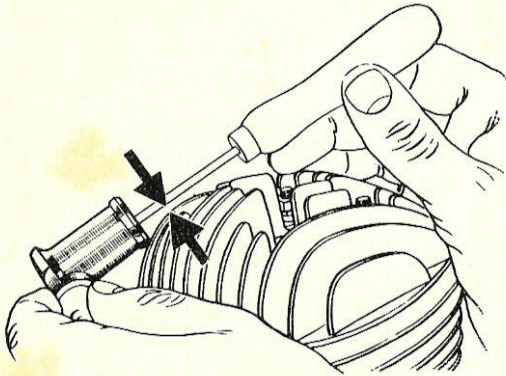

fig. 29

### III. mechanical troubles

Assumed is that carburettor and ignition are in good working order

Divided into: **A. engine troubles**  
**B. clutch troubles and Vee-belt troubles**

### A. engine troubles

1. **engine starts and pulls badly**  
carbon deposit in exhaust and scavenge ports, in exhaust pipe and silencer
2. **engine seizes**  
faulty oil or mixture ratio  
piston clearance too narrow. Old seizure marks not removed.  
Con-rod out of alignment: see pag. 8
3. **excessive fuel consumption**  
faulty membrane and/or carburetter  
always replace a faulty membrane
4. **engine produces rattling noises**  
worn little end bush: replace  
worn piston: replace  
piston rings jammed in grooves: free and replace  
worn clutch parts: replace

### B. clutch and Vee-belt troubles

Troubles are to be divided in:

- a. **troubles during the ride,**
- b. **troubles while the engine is idling.**

1. **starting engine is impossible or practically impossible**  
slipping belt (see pag. 11, para. 12)  
incorrectly adjusted starting cable (see page 4, para. 1)  
leaf spring bent and touches brim of clutch housing: replace
2. **clutch turns heavily**  
Vee-belt too tight  
bearing defective or dirty  
defective parts  
**after fitting a new friction plate**  
used plate too thick (non-genuine parts used)  
**after complete dismantling of clutch**  
saucer spring fitted the wrong way round
3. **clutch does not function and when housing is rotated, a grinding noise is audible**  
clutch spring has come undone: dismantle clutch, refill spring with 31 balls and re-connect spring with proper pre-load (see page 7, para. 8)
4. **clutch continues to slip, even when starting lever is pulled when riding**  
Vee-belt slips or friction plate is worn
5. **clutch drags when idling**  
idling speed too fast



STW MOENCHEN

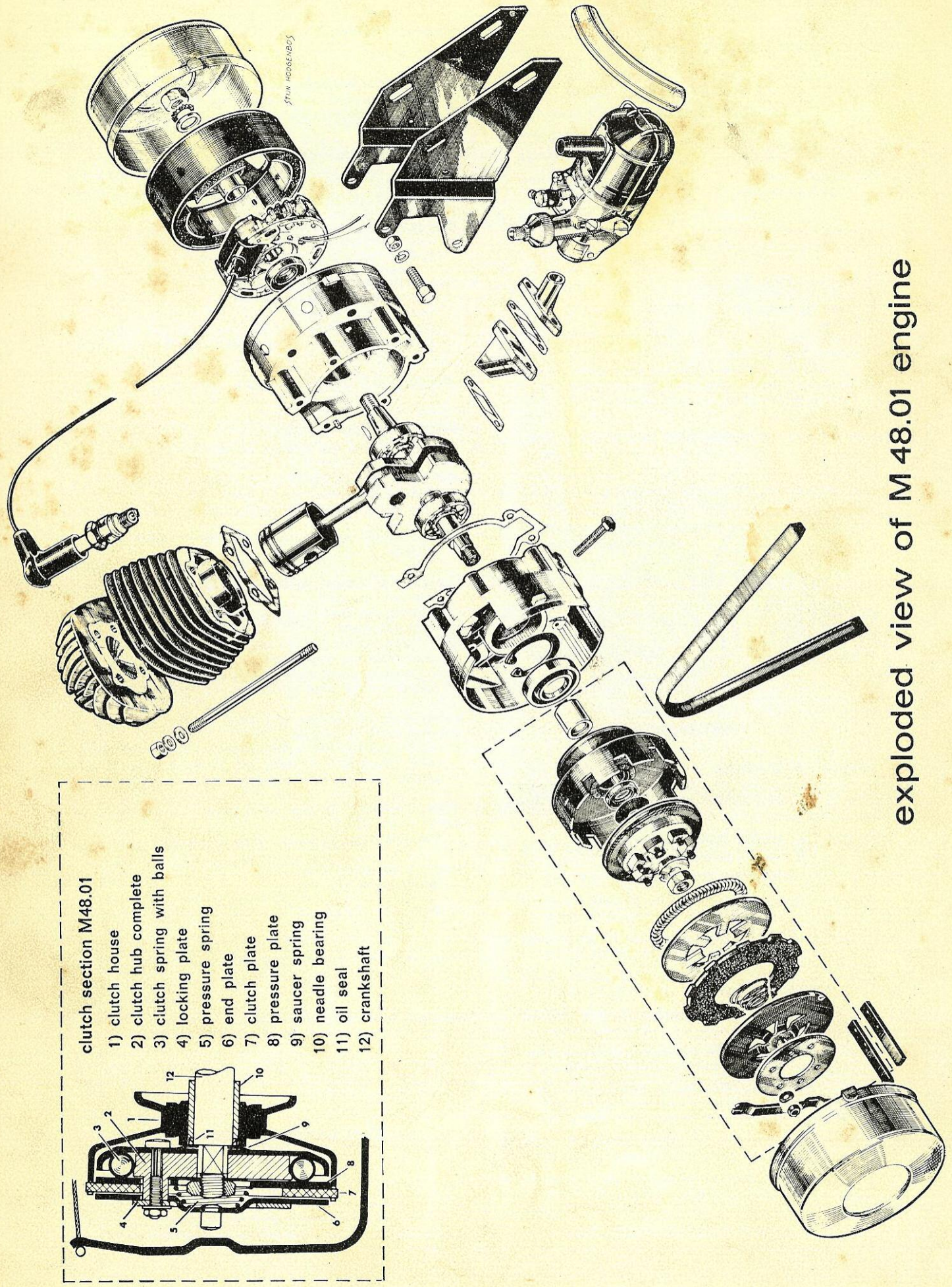

clutch section M48.01

- 1) clutch house
- 2) clutch hub complete
- 3) clutch spring with balls
- 4) locking plate
- 5) pressure spring
- 6) end plate
- 7) clutch plate
- 8) pressure plate
- 9) saucer spring
- 10) needle bearing
- 11) oil seal
- 12) crankshaft

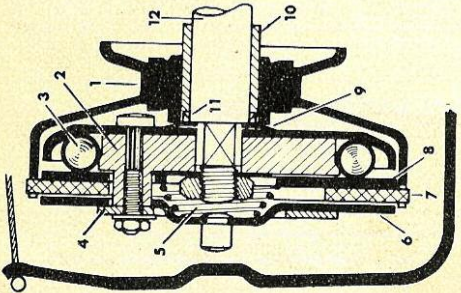

exploded view of M 48.01 engine



# IceniCAM Information Service

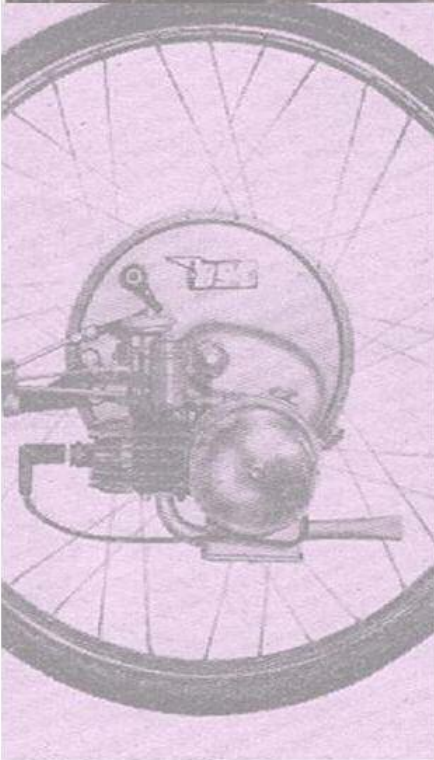

[www.icenicam.org.uk](http://www.icenicam.org.uk)