

Microfiche



www.xt250.de

YAMAHA XT 250 '81



YAMAHA





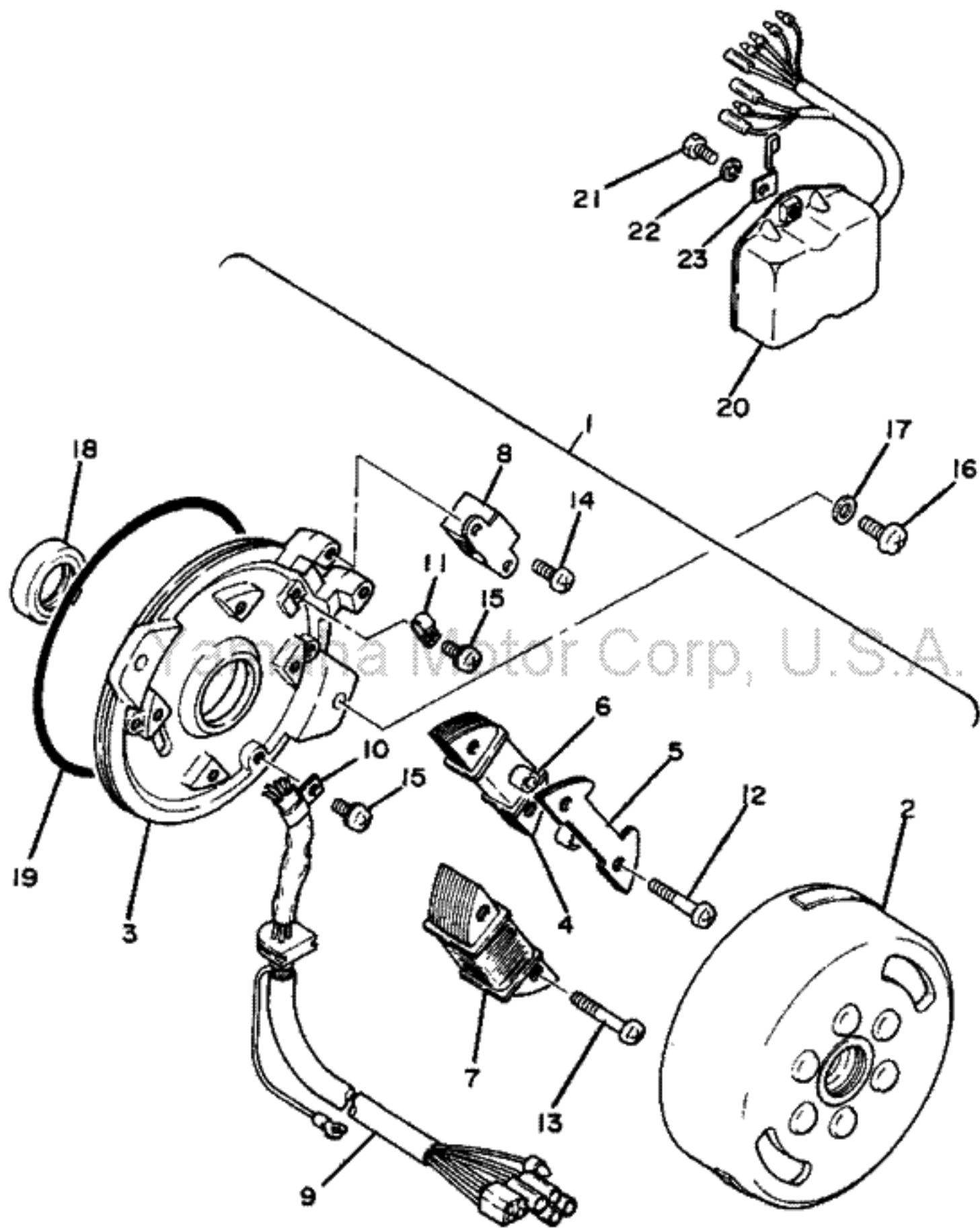



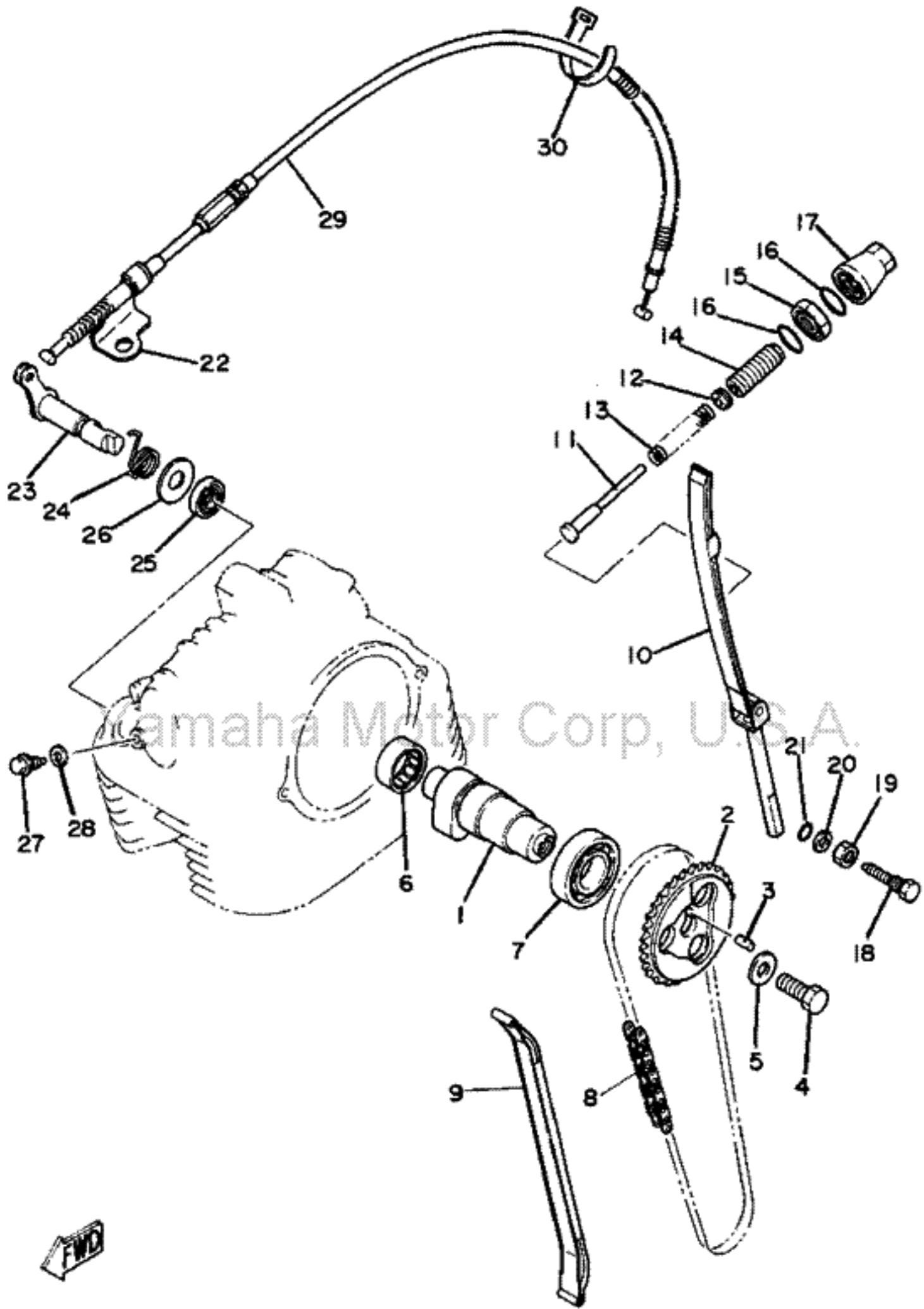







Touching Your Heart

11.08.2006 CrazyStevie









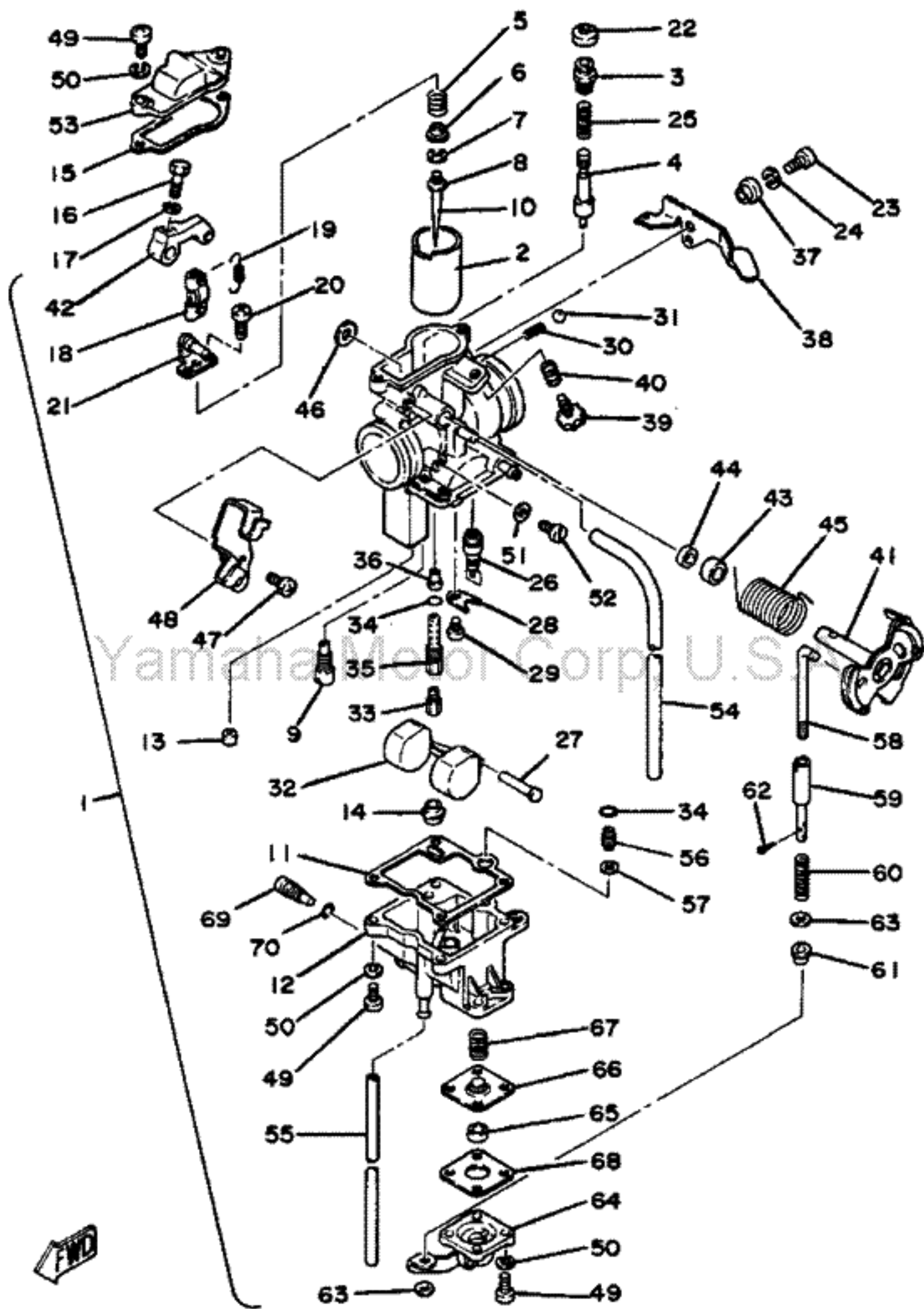







































Item	Part #	Description	Notes	Req	
1	3Y1-85500-20-00	C. D. I. MAGNETO ASS'Y		1	ADD TO WISH LIST 
2	3Y1-85550-20-00	ROTOR ASS'Y		1	ADD TO WISH LIST 
3	3Y1-85509-20-00	BASE, MAGNETO		1	ADD TO WISH LIST 
4	3Y1-85512-20-00	COIL, SOURCE		1	ADD TO WISH LIST 
5	3Y1-85519-20-00	SPACER		1	ADD TO WISH LIST 
6	3Y1-81343-20-00	COLLAR, COIL FITTING		2	ADD TO WISH LIST 
7	3Y1-85513-20-00	COIL, LIGHTING 1		1	ADD TO WISH LIST 
8	3Y1-85580-20-00	COIL, PULSER		1	ADD TO WISH LIST 
9	3Y1-85515-20-00	LEAD WIRE ASS'Y		1	ADD TO WISH LIST 
10	445-81328-20-00	CLAMP		1	ADD TO WISH LIST 
11	3Y1-85528-20-00	CLAMP, LEAD		1	ADD TO WISH LIST 
12	98501-05030-00	SCREW, PAN HEAD		2	ADD TO WISH LIST 
13	98501-05035-00	SCREW, PAN HEAD		2	ADD TO WISH LIST 
14	98503-05012-00	SCREW, PAN HEAD (98501-05012)		2	ADD TO WISH LIST 
15	110-81345-21-00	SCREW, PAN HEAD		2	ADD TO WISH LIST 
16	92503-06020-00	SCREW, PAN HEAD (92501-06020)		2	ADD TO WISH LIST 
17	92903-06200-00	WASHER, PLAIN (92901-06200)		2	ADD TO WISH LIST 
18	93102-25226-00	OIL SEAL		1	ADD TO WISH LIST 
19	93211-19413-00	O-RING		1	ADD TO WISH LIST 
20	3Y1-85540-20-00	C. D. I. UNIT ASS'Y		1	ADD TO WISH LIST 
21	97301-06016-00	BOLT (97301-06015)		2	ADD TO WISH LIST 
22	92903-06100-00	WASHER, SPRING (92902-06100)		2	ADD TO WISH LIST 
23	90462-08068-00	CLAMP		1	ADD TO WISH LIST 











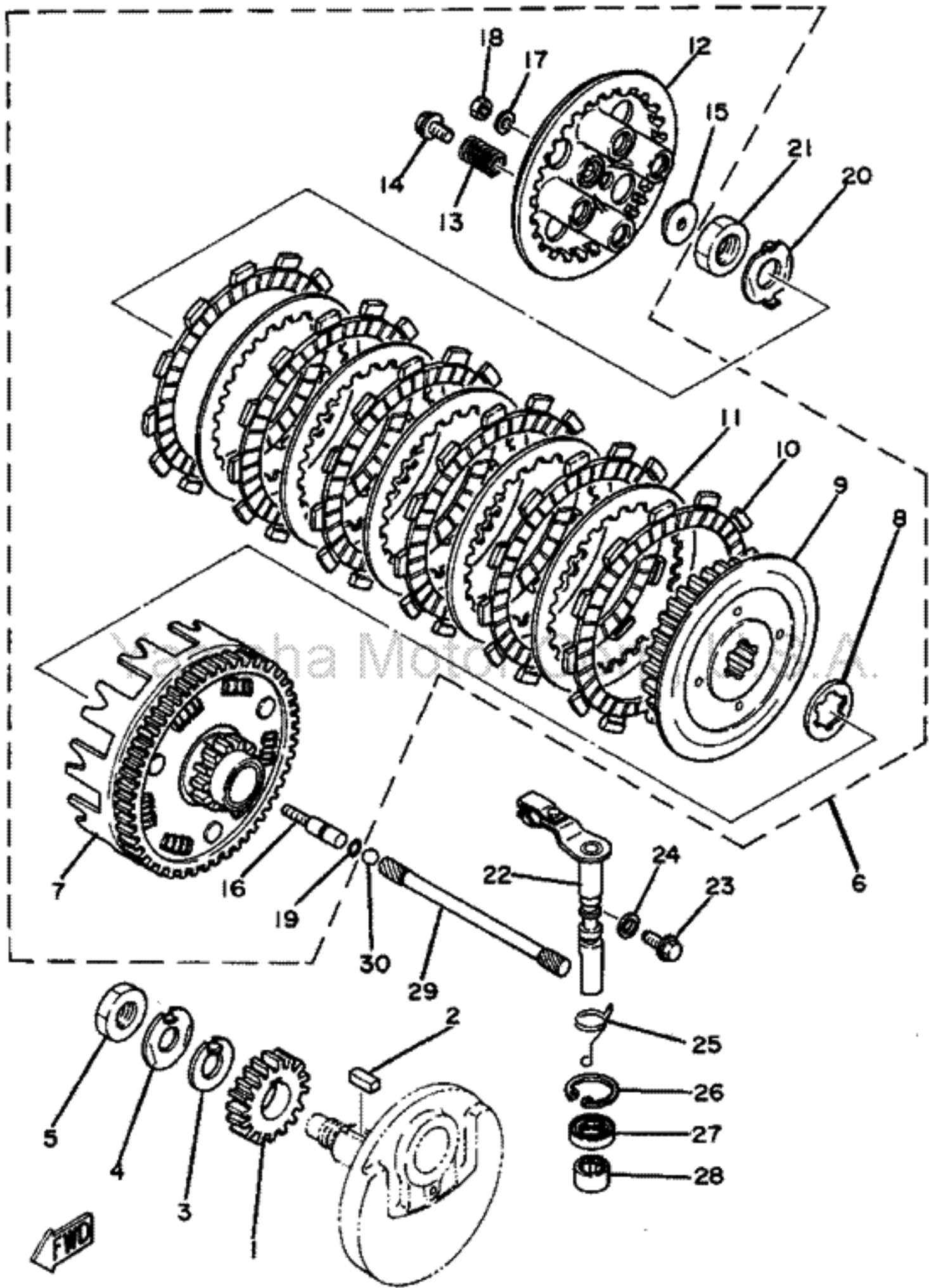









Item	Part #	Description	Notes	Req	
1	3Y1-12170-00-00	CAMSHAFT ASS'Y		1	ADD TO WISH LIST 
2	3Y1-12176-00-00	SPROCKET, CAM CHAIN (32T)		1	ADD TO WISH LIST 
3	93604-10011-00	PIN, DOWEL		1	ADD TO WISH LIST 
4	90101-10303-00	BOLT		1	ADD TO WISH LIST 
5	90201-10591-00	WASHER, PLATE			ADD TO WISH LIST 
6	93315-32516-00	BEARING, CYLINDRICAL			ADD TO WISH LIST 
7	93306-00501-00	BEARING (B6005)(93306-00502)		1	ADD TO WISH LIST 
8	94500-02090-00	CHAIN (BF05M 90L)		1	ADD TO WISH LIST 
9	3Y1-12231-01-00	GUIDE, STOPPER 1		1	ADD TO WISH LIST 
10	3Y1-12241-00-00	GUIDE, STOPPER 2		1	ADD TO WISH LIST 
11	3Y1-12217-00-00	ROD, CHAIN TENSIONER		1	ADD TO WISH LIST 
12	3Y1-12232-00-00	DAMPER		1	ADD TO WISH LIST 
13	90501-10587-00	SPRING, COMPRESSION		1	ADD TO WISH LIST 
14	90149-14146-00	SCREW,		1	ADD TO WISH LIST 
15	90179-14298-00	NUT,		1	ADD TO WISH LIST 
16	93210-16325-00	O-RING		2	ADD TO WISH LIST 
17	3Y1-12212-00-00	CASE, CHAIN TENSIONER		1	ADD TO WISH LIST 
18	90109-06555-00	BOLT		1	ADD TO WISH LIST 
19	95301-08700-00	NUT		1	ADD TO WISH LIST 
20	92901-06600-00	WASHER, PLATE		1	ADD TO WISH LIST 
21	93210-06001-00	O-RING		1	ADD TO WISH LIST 
22	3Y1-12283-00-00	BRACKET, DECOMP		1	ADD TO WISH LIST 
23	3Y1-12288-00-00	CAM, DECOMP		1	ADD TO WISH LIST 
24	90508-16428-00	SPRING, TORSION		1	ADD TO WISH LIST 
25	93102-12106-00	OIL SEAL		1	ADD TO WISH LIST 
26	90201-12588-00	WASHER, PLATE		1	ADD TO WISH LIST 
27	90109-06418-00	BOLT		1	ADD TO WISH LIST 
28	90430-06014-00	GASKET		1	ADD TO WISH LIST 
29	3Y1-12292-00-00	CABLE, DECOMP		1	ADD TO WISH LIST 
30	366-82591-00-00	BAND		1	ADD TO WISH LIST 











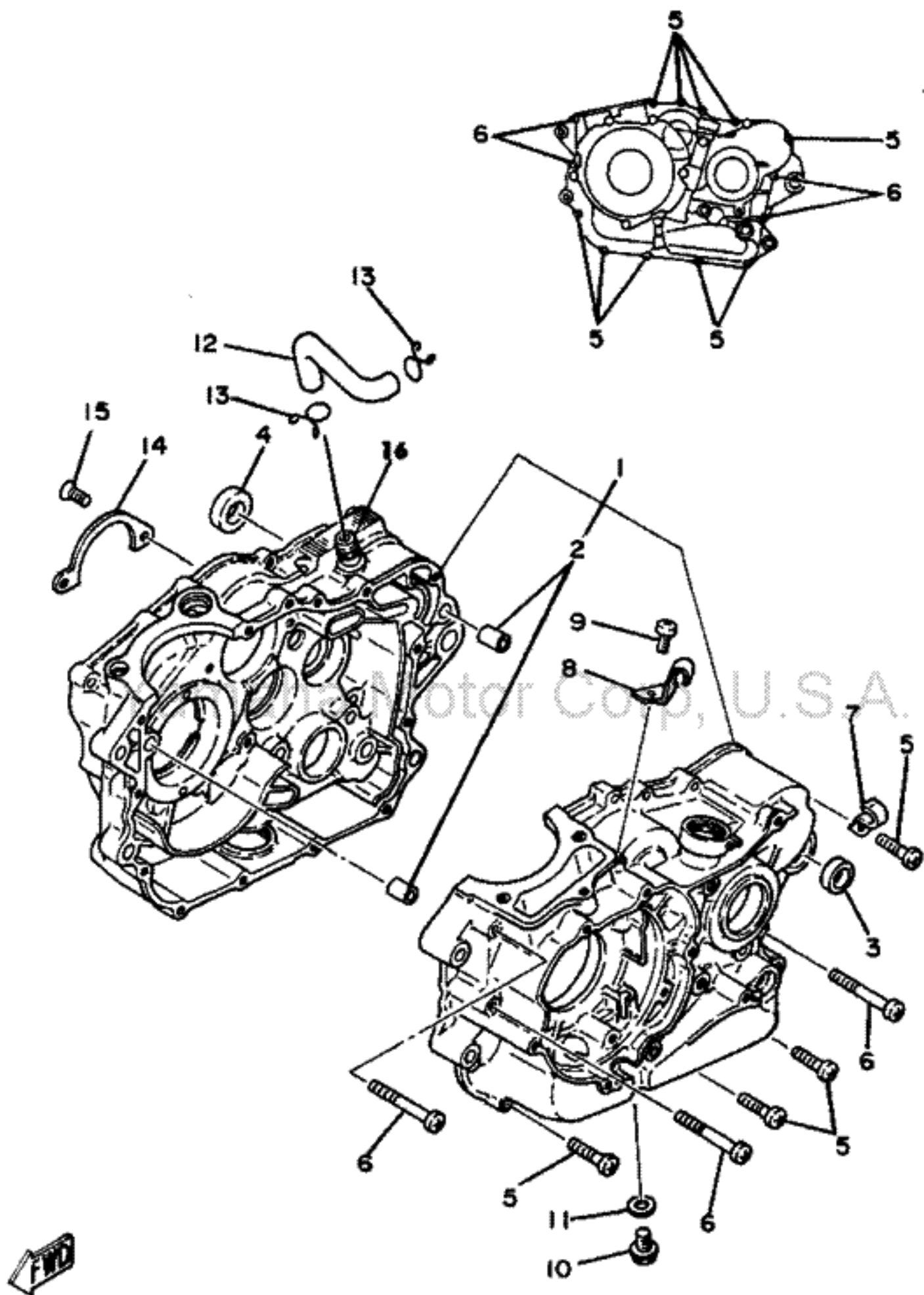







Item	Part #	Description	Notes	Req	
1	3Y1-14101-00-00	CARBURETOR ASS'Y 1		1	ADD TO WISH LIST 
2	3Y1-14112-25-00	VALVE, THROTTLE 1		1	ADD TO WISH LIST 
3	3Y1-14174-00-00	CAP, PLUNGER		1	ADD TO WISH LIST 
4	3Y1-14171-00-00	PLUNGER, STARTER		1	ADD TO WISH LIST 
5	3H1-14589-00-00	SPRING		1	ADD TO WISH LIST 
6	2N6-14227-00-00	WASHER		1	ADD TO WISH LIST 
7	164-14137-00-00	CLIP		1	ADD TO WISH LIST 
8	2N6-14918-01-00	RING		1	ADD TO WISH LIST 
9	3Y1-14142-17-A0	JET, PILOT (#17.5)		1	ADD TO WISH LIST 
10	168-14116-65-00	NEEDLE		1	ADD TO WISH LIST 
11	3Y1-14184-00-00	GASKET, FLOAT CHAMBER		1	ADD TO WISH LIST 
12	3Y1-14981-10-00	BODY, FLOAT CHAMBER		1	ADD TO WISH LIST 
13	3F9-14118-00-00	CAP (3A3-14118-00)		1	ADD TO WISH LIST 
14	3Y1-14153-00-00	WASHER, MAIN JET		1	ADD TO WISH LIST 
15	3Y1-14536-00-00	GASKET		1	ADD TO WISH LIST 
16	3Y1-14592-00-00	SCREW		1	ADD TO WISH LIST 
17	92901-04100-00	WASHER, SPRING (92903-04100)		1	ADD TO WISH LIST 
18	3Y1-14276-00-00	LEVER		1	ADD TO WISH LIST 
19	3Y1-14275-00-00	SPRING		1	ADD TO WISH LIST 
20	3Y1-24453-00-00	SCREW		2	ADD TO WISH LIST 
21	3Y1-14291-00-00	BRACKET 1		1	ADD TO WISH LIST 
22	1M3-14169-00-00	CAP		1	ADD TO WISH LIST 
23	92503-06012-00	SCREW, PAN HEAD (92501-06012)		1	ADD TO WISH LIST 
24	92903-06100-00	WASHER, SPRING (92902-06100)		1	ADD TO WISH LIST 
25	156-14135-00-00	SPRING, PLUNGER		1	ADD TO WISH LIST 
26	2H0-14190-20-00	NEEDLE VALVE ASS'Y		1	ADD TO WISH LIST 
27	537-14186-00-00	PIN, FLOAT		1	ADD TO WISH LIST 
28	2H0-14146-00-00	PLATE		1	ADD TO WISH LIST 
29	98501-04005-00	SCREW, PAN HEAD (98502-04006)		1	ADD TO WISH LIST 
30	583-14589-00-00	SPRING		1	ADD TO WISH LIST 
31	93501-08001-00	BALL		1	ADD TO WISH LIST 
32	3H1-14185-00-00	FLOAT		1	ADD TO WISH LIST 
33	137-14143-33-A0	JET, MAIN (#165)		1	ADD TO WISH LIST 
34	583-14561-00-00	O-RING		2	ADD TO WISH LIST 
35	3H1-14148-00-00	PIPE		1	ADD TO WISH LIST 
36	3Y1-14141-38-00	NOZZLE, MAIN		1	ADD TO WISH LIST 
37	583-14594-00-00	COLLAR		1	ADD TO WISH LIST 
38	3Y1-14175-00-00	LEVER, STARTER 1		1	ADD TO WISH LIST 
39	3Y1-14991-00-00	SCREW		1	ADD TO WISH LIST 
40	3F7-14934-00-00	SPRING, THROTTLE STOP		1	ADD TO WISH LIST 
41	3Y1-14215-00-00	SHAFT, THROTTLE LEVER		1	ADD TO WISH LIST 
42	3Y1-14292-00-00	BRACKET 2		1	ADD TO WISH LIST 
43	3F7-14265-00-00	COLLAR		1	ADD TO WISH LIST 

44	2A2-14997-00-00	SEAL	1	ADD TO WISH LIST 
45	3Y1-14131-00-00	SPRING, THROTTLE VALVE	1	ADD TO WISH LIST 
46	1A8-14958-00-00	COVER, DIAPHRAGM	1	ADD TO WISH LIST 
47	98501-05010-00	SCREW, PAN HEAD	2	ADD TO WISH LIST 
48	3Y1-14571-00-00	BRACKET, THROTTLE	1	ADD TO WISH LIST 
49	98503-04014-00	SCREW, PAN HEAD (98503-04015)	10	ADD TO WISH LIST 
50	92901-04100-00	WASHER, SPRING (92903-04100)	10	ADD TO WISH LIST 
51	584-14956-00-00	WASHER	1	ADD TO WISH LIST 
52	2F5-14115-00-00	PLUG, SCREW	1	ADD TO WISH LIST 
53	3Y1-14158-00-00	TOP, MIXING CHAMBER	1	ADD TO WISH LIST 
54	3Y1-14197-00-00	PIPE	1	ADD TO WISH LIST 
55	3Y3-14196-00-00	PIPE	1	ADD TO WISH LIST 
56	2H0-14272-00-00	VALVE, CHECK SEAT	1	ADD TO WISH LIST 
57	2H0-14195-00-00	WASHER, NEEDLE VALVE	1	ADD TO WISH LIST 
58	3Y1-14992-00-00	ROD	1	ADD TO WISH LIST 
59	2H0-14992-00-00	ROD	1	ADD TO WISH LIST 
60	3Y1-14933-00-00	SPRING, DIAPHRAGM	1	ADD TO WISH LIST 
61	2H0-14534-00-00	RING, ROD	1	ADD TO WISH LIST 
62	91402-10006-00	PIN, COTTER	1	ADD TO WISH LIST 
63	2H0-14227-00-00	WASHER	2	ADD TO WISH LIST 
64	3Y1-14905-00-00	LEVER, STARTER	1	ADD TO WISH LIST 
65	3Y0-14918-00-00	RING	1	ADD TO WISH LIST 
66	3Y1-14940-00-00	DIAPHRAGM ASS'Y	1	ADD TO WISH LIST 
67	3Y1-14589-00-00	SPRING	1	ADD TO WISH LIST 
68	3Y1-14936-00-00	SEAT, SPRING	1	ADD TO WISH LIST 
69	12R-14191-00-00	PLUG, DRAIN	1	ADD TO WISH LIST 
70	3Y1-14561-00-00	O-RING	1	ADD TO WISH LIST 



Item	Part #	Description	Notes	Req	
1	3Y1-16111-01-00	GEAR, PRIMARY DRIVE		1	ADD TO WISH LIST 
2	90282-07023-00	KEY, STRAIGHT		1	ADD TO WISH LIST 
3	90215-16156-00	WASHER, LOCK		1	ADD TO WISH LIST 
4	90215-16157-00	WASHER, LOCK		1	ADD TO WISH LIST 
5	90170-16256-00	NUT		1	ADD TO WISH LIST 
6	3Y1-16300-01-00	CLUTCH ASS'Y		1	ADD TO WISH LIST 
7	3Y1-16150-01-00	PRIMARY DRIVEN GEAR COMP		1	ADD TO WISH LIST 
8	3Y1-16154-00-00	PLATE, THRUST 1		1	ADD TO WISH LIST 
9	3Y1-16371-00-00	BOSS, CLUTCH		1	ADD TO WISH LIST 
10	583-16321-00-00	PLATE, FRICTION		6	ADD TO WISH LIST 
11	360-16325-00-00	PLATE, CLUTCH 2		5	ADD TO WISH LIST 
12	3Y1-16351-00-00	PLATE, PRESSURE 1		12	ADD TO WISH LIST 
13	90501-26148-00	SPRING, COMPRESSION		4	ADD TO WISH LIST 
14	90159-06016-00	SCREW, WITH WASHER		4	ADD TO WISH LIST 
15	1W1-16358-00-00	PLATE, PUSH		1	ADD TO WISH LIST 
16	3Y1-16356-01-00	ROD, PUSH 1		1	ADD TO WISH LIST 
17	92903-06200-00	WASHER, PLAIN (92901-06200)		1	ADD TO WISH LIST 
18	95301-06600-00	NUT		1	ADD TO WISH LIST 
19	93210-06422-00	O-RING		1	ADD TO WISH LIST 
20	90215-20159-00	WASHER, LOCK		1	ADD TO WISH LIST 
21	90170-20257-00	NUT		1	ADD TO WISH LIST 
22	3Y1-16380-01-00	PUSH LEVER ASS'Y		1	ADD TO WISH LIST 
23	90149-08067-00	SCREW		1	ADD TO WISH LIST 
24	90430-08119-00	GASKET		1	ADD TO WISH LIST 
25	90508-14433-00	SPRING, TORSION		1	ADD TO WISH LIST 
26	93420-28055-00	CIRCLIP		1	ADD TO WISH LIST 
27	93102-14209-00	OIL SEAL		1	ADD TO WISH LIST 
28	93315-31428-00	BEARING, CYLINDRICAL		1	ADD TO WISH LIST 
29	3Y1-16357-00-00	ROD, PUSH 2		1	ADD TO WISH LIST 
30	93511-32017-00	BALL		1	ADD TO WISH LIST 





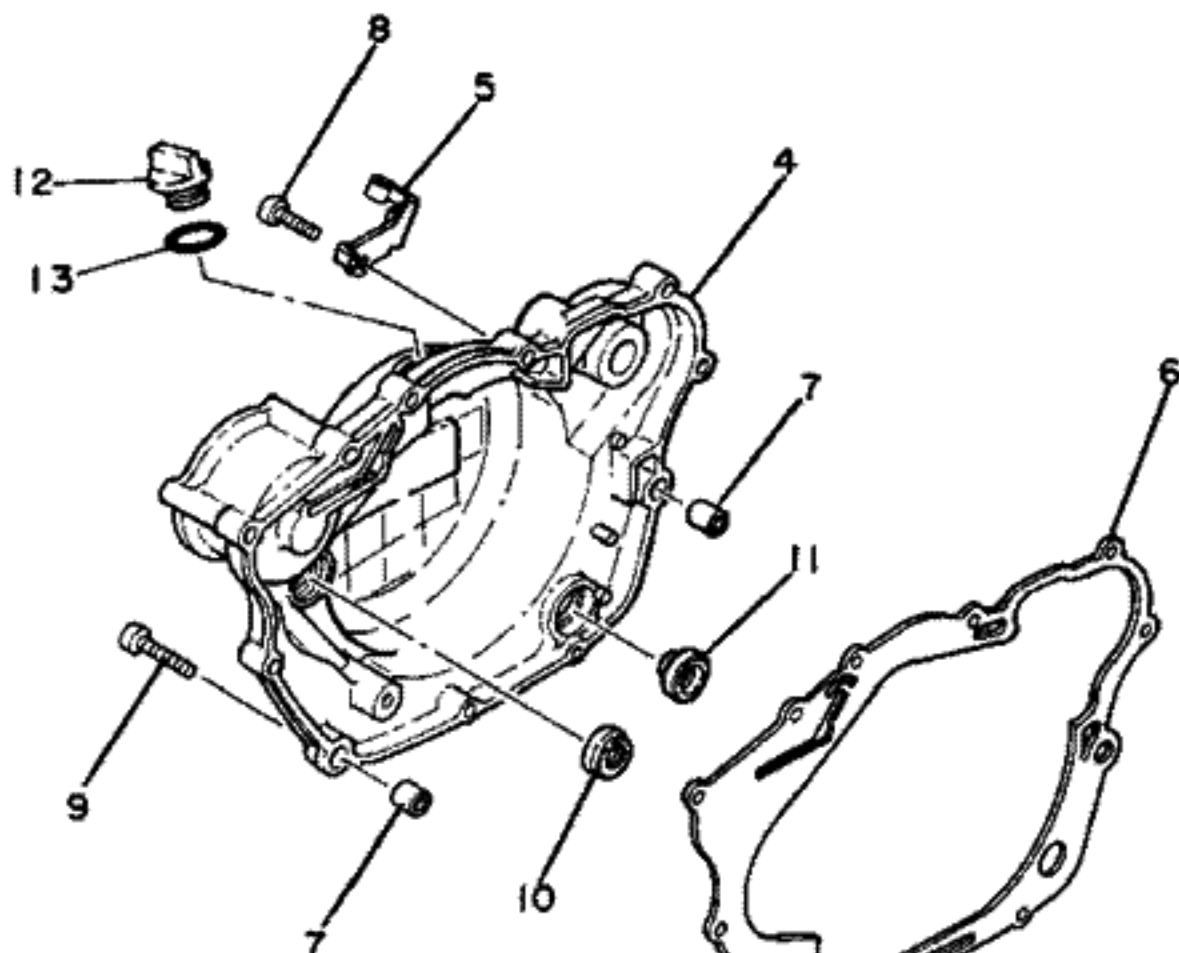



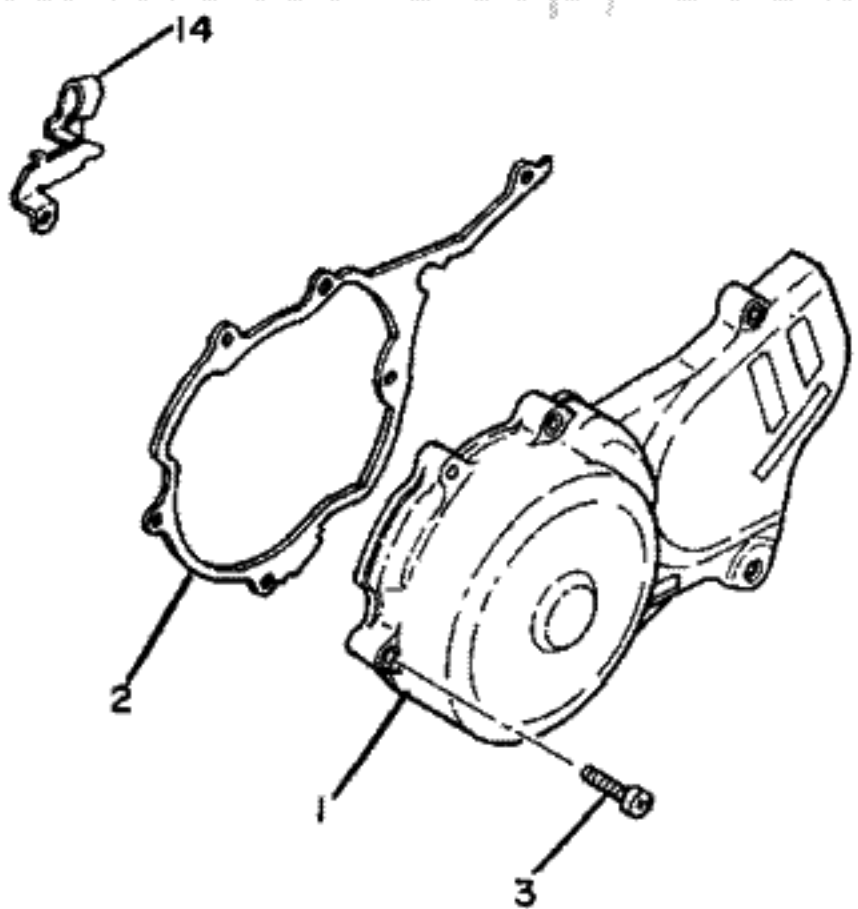







Item	Part #	Description	Notes	Req	
1	3Y1-15100-02-00	CRANKCASE ASS'Y		1	ADD TO WISH LIST 
2	91830-22016-00	PIN, DOWEL		2	ADD TO WISH LIST 
3	90387-17783-00	COLLAR		1	ADD TO WISH LIST 
4	90387-16782-00	COLLAR		1	ADD TO WISH LIST 
5	92506-06030-00	SCREW, PAN HEAD		10	ADD TO WISH LIST 
6	92506-06060-00	SCREW, PAN HEAD		4	ADD TO WISH LIST 
7	90465-08122-00	CLAMP		1	ADD TO WISH LIST 
8	3Y1-15441-01-00	HOLDER, CLUTCH CABLE		1	ADD TO WISH LIST 
9	92503-06015-00	SCREW, PAN HEAD (92501-06015)		1	ADD TO WISH LIST 
10	90340-10003-00	PLUG, STRAIGHT SCREW		1	ADD TO WISH LIST 
11	90201-10118-00	WASHER, PLATE		1	ADD TO WISH LIST 
12	3Y1-11166-00-00	PIPE, BREATHER 1		1	ADD TO WISH LIST 
13	90467-14015-00	CLIP		2	ADD TO WISH LIST 
14	3Y1-15383-00-00	PLATE, BEARING COVER		1	ADD TO WISH LIST 
15	92701-06015-00	SCREW, FLAT HEAD		2	ADD TO WISH LIST 
16	371-11167-01-00	PIPE, BREATHER 2		1	ADD TO WISH LIST 









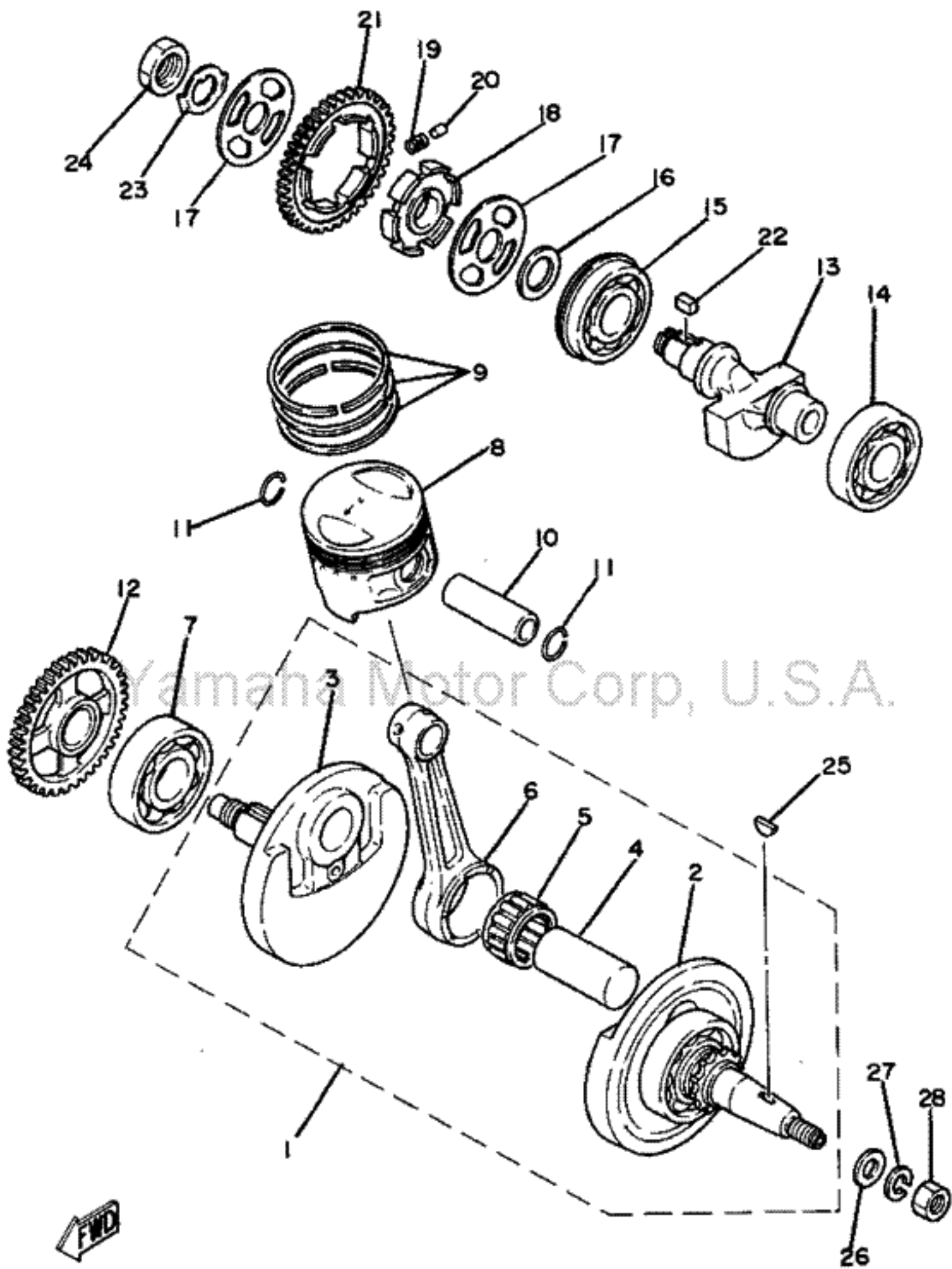





























Yamaha Motor Corp, U.S.A.



Item	Part #	Description	Notes	Req	
1	3Y1-15411-01-00	COVER, CRANKCASE 1		1	ADD TO WISH LIST 
2	3Y1-15451-01-00	GASKET, CRANKCASE COVER		1	ADD TO WISH LIST 
3	92506-06030-00	SCREW, PAN HEAD		6	ADD TO WISH LIST 
4	3Y1-15421-00-00	COVER, CRANKCASE 2		1	ADD TO WISH LIST 
5	3Y1-15378-01-00	HOLDER		1	ADD TO WISH LIST 
6	3Y1-15461-00-00	GASKET, CRANKCASE COVER 2		1	ADD TO WISH LIST 
7	91830-22016-00	PIN, DOWEL (91810-05016)		2	ADD TO WISH LIST 
8	92506-06025-00	SCREW, PAN HEAD		7	ADD TO WISH LIST 
9	92506-06035-00	SCREW, PAN HEAD		2	ADD TO WISH LIST 
10	93101-14092-00	OIL SEAL		1	ADD TO WISH LIST 
11	3Y1-15361-00-00	GAUGE, LEVEL		1	ADD TO WISH LIST 
12	3Y1-15363-00-00	PLUG, OIL		1	ADD TO WISH LIST 
13	93210-19123-00	O-RING		1	ADD TO WISH LIST 
14	90462-08062-00	CLAMP		1	ADD TO WISH LIST 





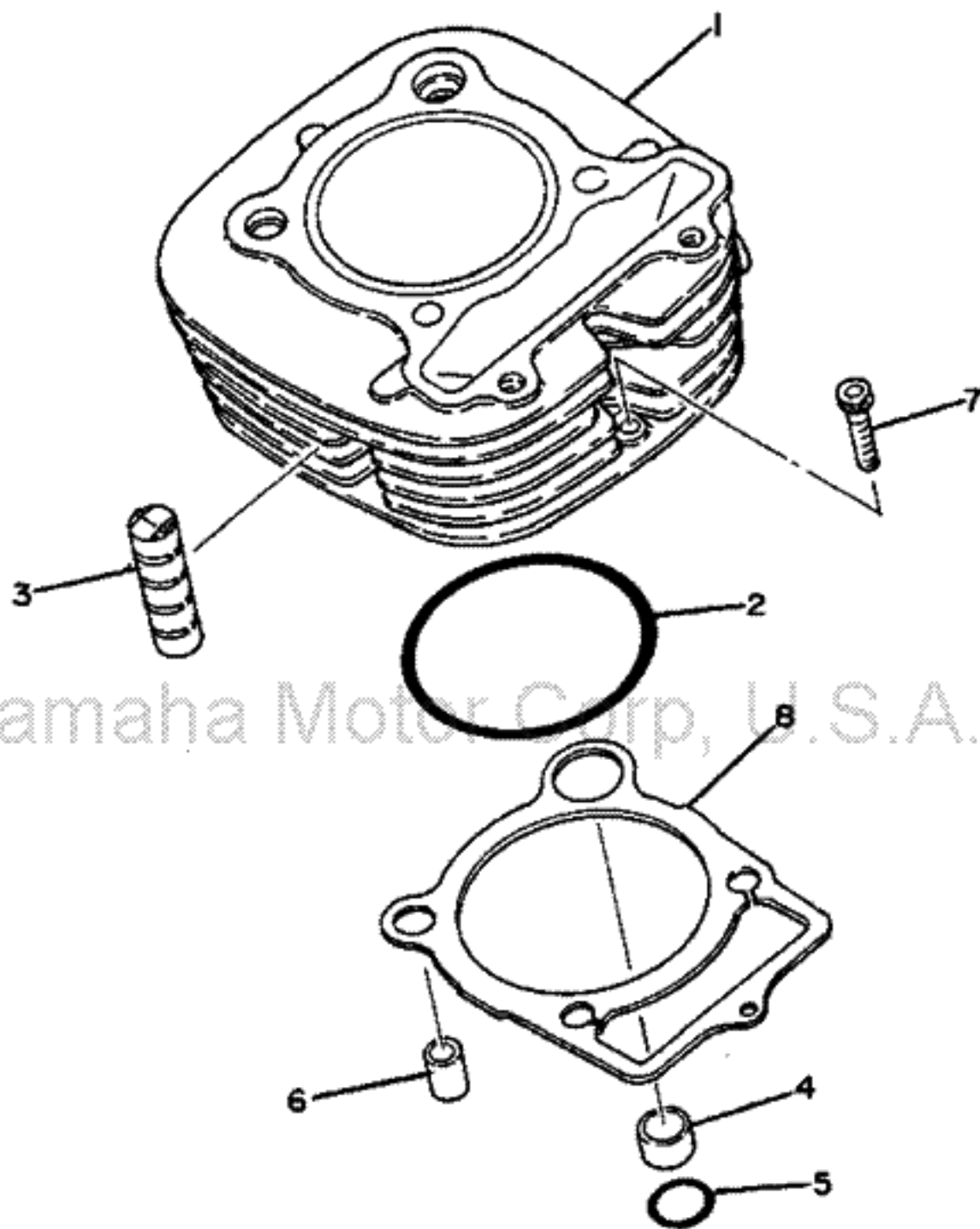





Item	Part #	Description	Notes	Req	
1	3Y1-11400-00-00	CRANK SHAFT ASS'Y		1	ADD TO WISH LIST 
2	3Y1-11412-09-00	CRANK 1		1	ADD TO WISH LIST 
3	3Y1-11422-00-00	CRANK 2		1	ADD TO WISH LIST 
4	3Y1-11681-00-00	PIN, CRANK 1		1	ADD TO WISH LIST 
5	93310-831H1-00	BEARING, CYLINDRICAL		1	ADD TO WISH LIST 
6	3Y1-11651-00-00	ROD, CONNECTING		1	ADD TO WISH LIST 
7	93306-30616-00	BEARING (B6306)		1	ADD TO WISH LIST 
8	3Y1-11631-00-A0	PISTON (STD)		1	ADD TO WISH LIST 
8	3Y1-11635-00-00	PISTON (1ST O/S 0.25MM)	ALTERNATE PARTS	1	ADD TO WISH LIST 
8	3Y1-11636-00-00	PISTON (2ND O/S 0.50MM)	ALTERNATE PARTS	1	ADD TO WISH LIST 
8	3Y1-11637-00-00	PISTON (3RD O/S 0.75MM)	ALTERNATE PARTS	1	ADD TO WISH LIST 
8	3Y1-11638-00-00	PISTON (4TH O/S 1.00MM)	ALTERNATE PARTS	1	ADD TO WISH LIST 
9	3Y1-11610-00-00	PISTON RING SET (STD)		1	ADD TO WISH LIST 
9	3Y1-11610-10-00	PISTON RING SET (1ST O/S)	ALTERNATE PARTS	1	ADD TO WISH LIST 
9	3Y1-11610-20-00	PISTON RING SET (2ND O/S)	ALTERNATE PARTS	1	ADD TO WISH LIST 
9	3Y1-11610-30-00	PISTON RING SET (3RD O/S)	ALTERNATE PARTS	1	ADD TO WISH LIST 
9	3Y1-11610-40-00	PISTON RING SET (4TH O/S)	ALTERNATE PARTS	1	ADD TO WISH LIST 
10	447-11633-00-00	PIN, PISTON		1	ADD TO WISH LIST 
11	93450-22027-00	CIRCLIP		2	ADD TO WISH LIST 
12	3Y1-11536-00-00	GEAR, DRIVE (43T)		1	ADD TO WISH LIST 
13	3Y1-11454-00-00	WEIGHT 1		1	ADD TO WISH LIST 
14	93306-30525-00	BEARING (B6305)		1	ADD TO WISH LIST 
15	93306-30526-00	BEARING (83A539SN2-9C3)		1	ADD TO WISH LIST 
16	90201-20792-00	WASHER, PLATE		1	ADD TO WISH LIST 
17	3Y1-11565-00-00	WASHER, BEARING COVER		2	ADD TO WISH LIST 
18	3Y1-11496-00-00	BOSS, BUFFER		1	ADD TO WISH LIST 
19	90501-21133-00	SPRING, COMPRESSION		6	ADD TO WISH LIST 
20	93605-10090-00	PIN, DOWEL		3	ADD TO WISH LIST 
21	3Y1-11531-00-00	GEAR, BALANCE WT (43T)		1	ADD TO WISH LIST 
22	90282-05013-00	KEY, STRAIGHT		1	ADD TO WISH LIST 
23	90215-20158-00	WASHER, LOCK		1	ADD TO WISH LIST 
24	90179-16018-00	NUT		1	ADD TO WISH LIST 
25	90280-05013-00	KEY, WOODRUFF		1	ADD TO WISH LIST 
26	90201-12593-00	WASHER, PLATE		1	ADD TO WISH LIST 
27	92901-12100-00	WASHER, SPRING		1	ADD TO WISH LIST 
28	90170-12067-00	NUT		1	ADD TO WISH LIST 



Yamaha Motor Corp, U.S.A.





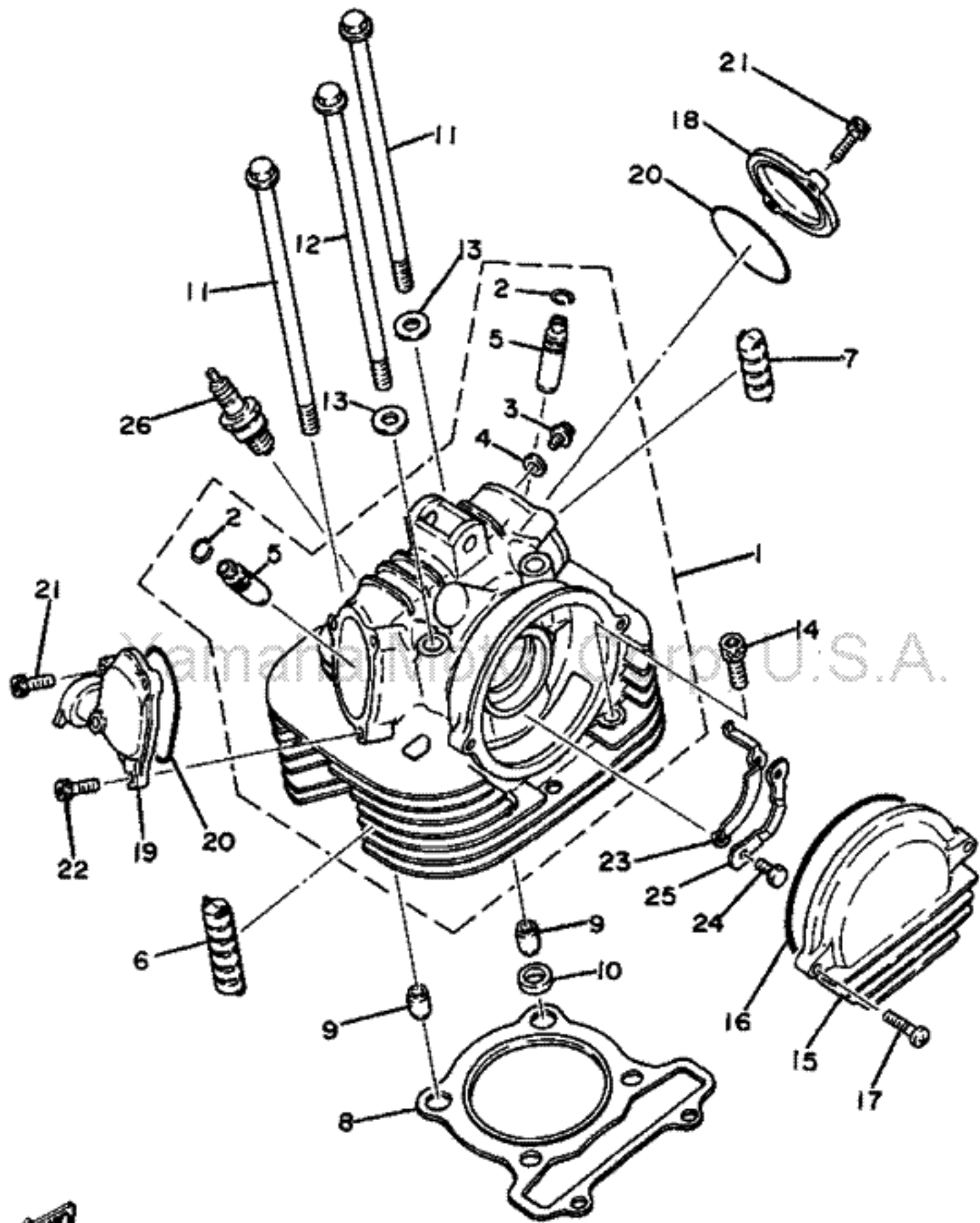



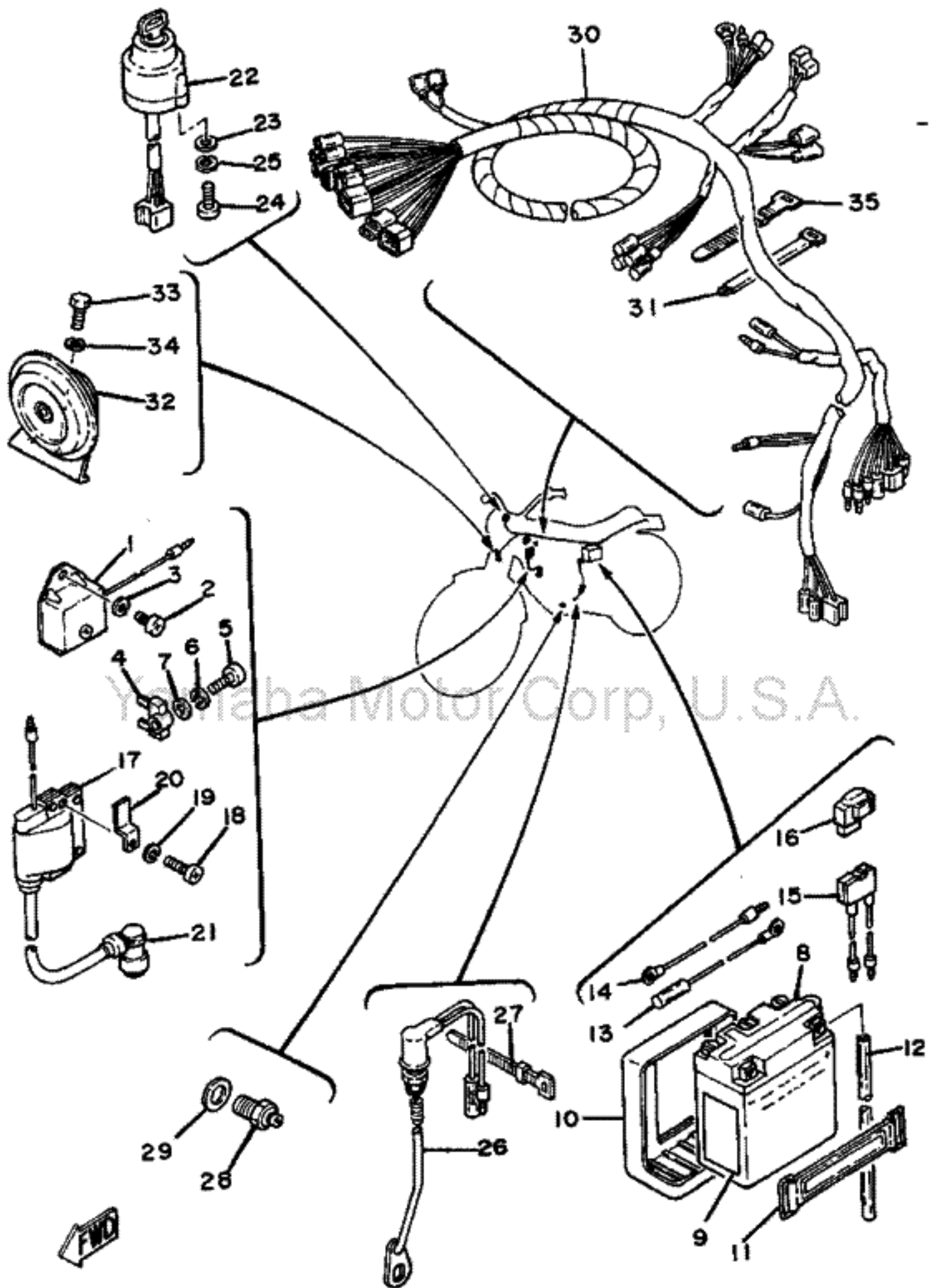



























Item	Part #	Description	Notes	Req	
1	3Y1-11310-00-00	CYLINDER		1	ADD TO WISH LIST 
2	93210-81411-00	O-RING		1	ADD TO WISH LIST 
3	3Y1-11162-00-00	ABSORBER 2		4	ADD TO WISH LIST 
4	90387-16547-00	COLLAR		1	ADD TO WISH LIST 
5	93210-18322-00	O-RING		1	ADD TO WISH LIST 
6	91830-24016-00	PIN, DOWEL		1	ADD TO WISH LIST 
7	91316-06030-00	BOLT		1	ADD TO WISH LIST 
8	3Y1-11351-01-00	GASKET, CYLINDER		1	ADD TO WISH LIST 









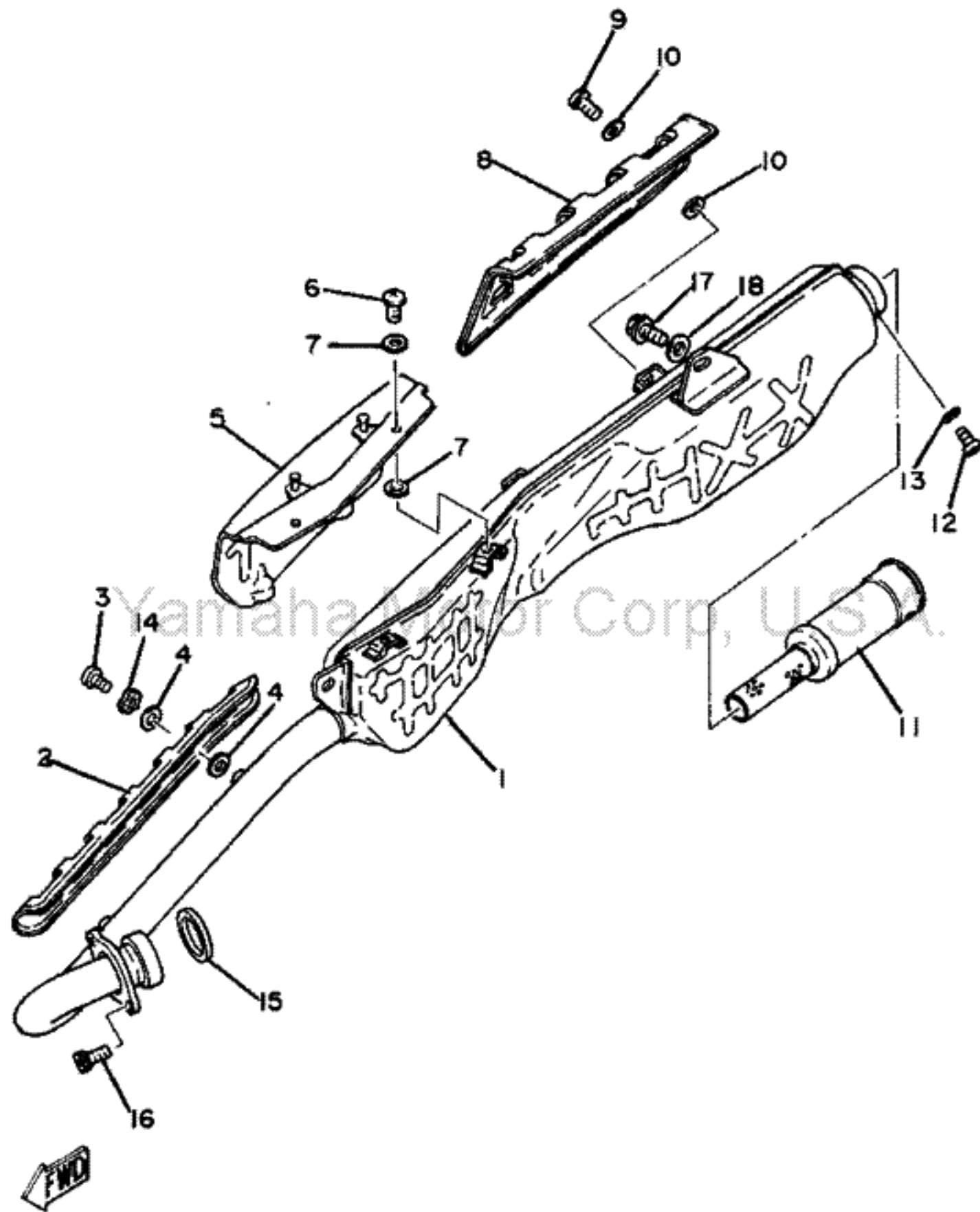











Item	Part #	Description	Notes	Req	
1	3Y1-11110-00-00	CYLINDER HEAD ASSY		1	ADD TO WISH LIST 
2	93440-12052-00	CIRCLIP		2	ADD TO WISH LIST 
3	90153-06029-00	SCREW, HEXAGON		1	ADD TO WISH LIST 
4	90430-06014-00	GASKET		1	ADD TO WISH LIST 
5	3Y1-11133-10-00	GUIDE , INTAKE VALVE (1ST O/S)		2	ADD TO WISH LIST 
6	3Y1-11127-00-00	ABSORBER 3		3	ADD TO WISH LIST 
7	3Y1-11161-00-00	ABSORBER 1		1	ADD TO WISH LIST 
8	3Y1-11181-01-00	GASKET, CYLINDER HEAD 1		1	ADD TO WISH LIST 
9	91830-24016-00	PIN, DOWEL		2	ADD TO WISH LIST 
10	90430-14131-00	GASKET		1	ADD TO WISH LIST 
11	90105-10140-00	BOLT, WASHER BASED		2	ADD TO WISH LIST 
12	90105-10139-00	BOLT, WASHER BASED		2	ADD TO WISH LIST 
13	90201-10128-00	WASHER, PLATE		3	ADD TO WISH LIST 
14	91316-08050-00	BOLT		2	ADD TO WISH LIST 
15	3Y1-11185-00-00	COVER, CYLINDER HEAD SIDE 1		1	ADD TO WISH LIST 
16	93211-06485-00	O-RING (93211-07410)		1	ADD TO WISH LIST 
17	92506-06025-00	SCREW, PAN HEAD		2	ADD TO WISH LIST 
18	3Y1-11186-00-00	COVER, CYLINDER HEAD SIDE 2		1	ADD TO WISH LIST 
19	3Y1-11187-00-00	COVER, CYLINDER HEAD SIDE 3		1	ADD TO WISH LIST 
20	93210-57412-00	O-RING		2	ADD TO WISH LIST 
21	91316-06020-00	BOLT		4	ADD TO WISH LIST 
22	90109-06556-00	BOLT		1	ADD TO WISH LIST 
23	3Y1-1111F-00-00	PLATE		1	ADD TO WISH LIST 
24	97301-06012-00	BOLT		2	ADD TO WISH LIST 
25	90215-06162-00	WASHER, LOCK		1	ADD TO WISH LIST 
26	94701-00117-00	PLUG, SPARK (NGK BP-7ES)		1	ADD TO WISH LIST 



Item	Part #	Description	Notes	Req	
1	498-81910-23-00	VOLTAGE REGULATOR ASS'Y		1	ADD TO WISH LIST 
2	92503-06012-00	SCREW, PAN HEAD (92501-06012)		2	ADD TO WISH LIST 
3	92903-06100-00	WASHER, SPRING (92902-06100)		2	ADD TO WISH LIST 
4	1M1-81970-60-00	RECTIFIER ASS'Y		1	ADD TO WISH LIST 
5	98503-05020-00	SCREW, PAN HEAD (98501-05020)		1	ADD TO WISH LIST 
6	92903-05100-00	WASHER, SPRING (92902-05100)		1	ADD TO WISH LIST 
7	92901-05600-00	WASHER, PLATE		1	ADD TO WISH LIST 
8	1E6-82110-29-00	BATTERY ASS'Y (6N6-3B-1)		1	ADD TO WISH LIST 
9	LIT-82141-09-00	LABEL, BATTERY (118-82141-09)		1	ADD TO WISH LIST 
10	3Y1-82122-00-00	SEAT, BATTERY		1	ADD TO WISH LIST 
11	1E6-82131-00-00	BAND, BATTERY		1	ADD TO WISH LIST 
12	90445-08348-00	HOSE		1	ADD TO WISH LIST 
13	2A6-82115-00-00	WIRE, PLUS LEAD		1	ADD TO WISH LIST 
14	1M1-82519-00-00	WIRE, EARTH LEAD		1	ADD TO WISH LIST 
15	3J0-82181-00-00	CIRCUIT BREAKER COMP		1	ADD TO WISH LIST 
16	3J0-82182-00-00	COVER, CIRCUIT BREAKER		1	ADD TO WISH LIST 
17	3Y1-82310-40-00	IGNITION COIL ASS'Y		1	ADD TO WISH LIST 
18	92501-06025-00	SCREW, PAN HEAD (92502-06025)		2	ADD TO WISH LIST 
19	92903-06100-00	WASHER, SPRING (92902-06100)		2	ADD TO WISH LIST 
20	3Y1-82594-00-00	CLAMP		1	ADD TO WISH LIST 
21	1L9-82370-00-00	PLUG CAP ASS'Y		1	ADD TO WISH LIST 
22	2A6-82508-20-00	MAIN SWITCH ASS'Y		1	ADD TO WISH LIST 
23	90201-05033-00	WASHER, PLATE		2	ADD TO WISH LIST 
24	98503-05025-00	SCREW, PAN HEAD (98501-05025)		2	ADD TO WISH LIST 
25	92903-05100-00	WASHER, SPRING (92902-05100)		2	ADD TO WISH LIST 
26	3Y1-82530-00-00	STOP SWITCH ASS'Y		1	ADD TO WISH LIST 
27	437-83936-00-00	BAND, SWITCH CORD		1	ADD TO WISH LIST 
28	2H7-82540-00-00	NEUTRAL SWITCH ASS'Y		1	ADD TO WISH LIST 
29	90430-10148-00	GASKET		1	ADD TO WISH LIST 
30	3Y1-82590-50-00	WIRE HARNESS ASS'Y		1	ADD TO WISH LIST 
31	341-26397-01-00	BAND		1	ADD TO WISH LIST 
32	3Y1-83371-10-00	HORN		1	ADD TO WISH LIST 
33	97301-06012-00	BOLT (97302-06012)		2	ADD TO WISH LIST 
34	92903-06100-00	WASHER, SPRING (92902-06100)		2	ADD TO WISH LIST 
35	437-83936-00-00	BAND, SWITCH CORD		1	ADD TO WISH LIST 



Item	Part #	Description	Notes	Req	
1	3Y1-14711-00-00	MUFFLER 1		1	ADD TO WISH LIST 
2	3Y1-14628-00-00	PROTECTOR, EXHAUST PIPE		1	ADD TO WISH LIST 
3	98906-06008-00	SCREW, BIND		2	ADD TO WISH LIST 
4	583-14766-00-00	WASHER, PROTECTOR		4	ADD TO WISH LIST 
5	3Y1-14718-00-00	PROTECTOR, MUFFLER 1		1	ADD TO WISH LIST 
6	98906-06008-00	SCREW, BIND		3	ADD TO WISH LIST 
7	583-14766-00-00	WASHER, PROTECTOR		6	ADD TO WISH LIST 
8	3Y1-14728-00-00	PROTECTOR, MUFFLER 2		1	ADD TO WISH LIST 
9	98906-06008-00	SCREW, BIND		2	ADD TO WISH LIST 
10	583-14766-00-00	WASHER, PROTECTOR		4	ADD TO WISH LIST 
11	3Y1-14752-00-00	PIPE, OUTLET		1	ADD TO WISH LIST 
12	92501-06008-00	SCREW, PAN HEAD		1	ADD TO WISH LIST 
13	92903-06100-00	WASHER, SPRING (92901-06100)		1	ADD TO WISH LIST 
14	90206-06060-00	WASHER, WAVE		4	ADD TO WISH LIST 
15	341-14613-00-00	GASKET, EXHAUST PIPE		1	ADD TO WISH LIST 
16	91316-06020-00	BOLT		2	ADD TO WISH LIST 
17	95811-08016-00	BOLT, FLANGE		2	ADD TO WISH LIST 
18	90201-08326-00	WASHER, PLATE		1	ADD TO WISH LIST 

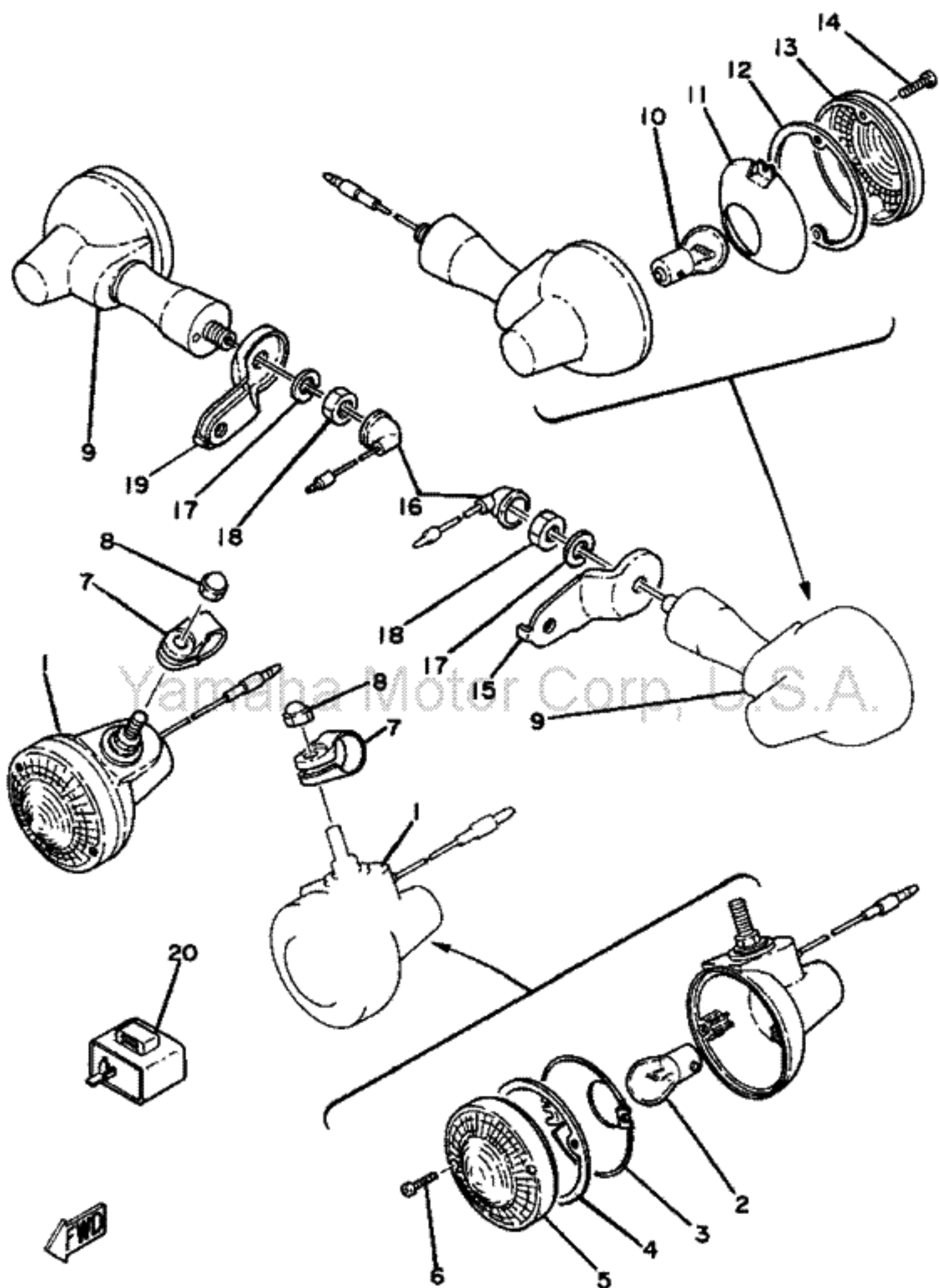

Item	Part #	Description	Notes	Req	
1	1M1-83310-60-00	FRONT FLASHER LIGHT ASS'Y		2	ADD TO WISH LIST 
2	115-83311-60-00	BULB (6V-18W)		1	ADD TO WISH LIST 
3	1M1-83309-60-00	REFLECTOR		1	ADD TO WISH LIST 
4	1M1-83313-60-00	GASKET, FLASHER LENS		1	ADD TO WISH LIST 
5	341-83312-70-00	LENS, FLASHER		1	ADD TO WISH LIST 
6	97701-30520-00	SCREW, PAN HEAD TAPPING		2	ADD TO WISH LIST 
7	1M1-83318-00-00	STAY, FLASHER 1		2	ADD TO WISH LIST 
8	95303-08800-00	NUT, CROWN		2	ADD TO WISH LIST 
9	1T9-83330-60-00	REAR FLASHER LIGHT ASS'Y		12	ADD TO WISH LIST 
10	115-83311-60-00	BULB (6V-18W)		1	ADD TO WISH LIST 
11	1M1-83309-60-00	REFLECTOR		1	ADD TO WISH LIST 
12	1M1-83313-60-00	GASKET, FLASHER LENS		1	ADD TO WISH LIST 
13	341-83312-70-00	LENS, FLASHER		1	ADD TO WISH LIST 
14	97701-30520-00	SCREW, PAN HEAD TAPPING		2	ADD TO WISH LIST 
15	1T2-83368-00-00	STAY, FLASHER		1	ADD TO WISH LIST 
16	3Y1-83365-00-00	CAP		2	ADD TO WISH LIST 
17	92903-10100-00	WASHER, SPRING (92901-10100)		2	ADD TO WISH LIST 
18	95301-10600-00	NUT (95302-10600)		2	ADD TO WISH LIST 
19	1T2-83369-00-00	STAY, FLASHER		1	ADD TO WISH LIST 
20	2A6-83350-60-00	FLASHER RELAY ASS'Y		1	ADD TO WISH LIST 

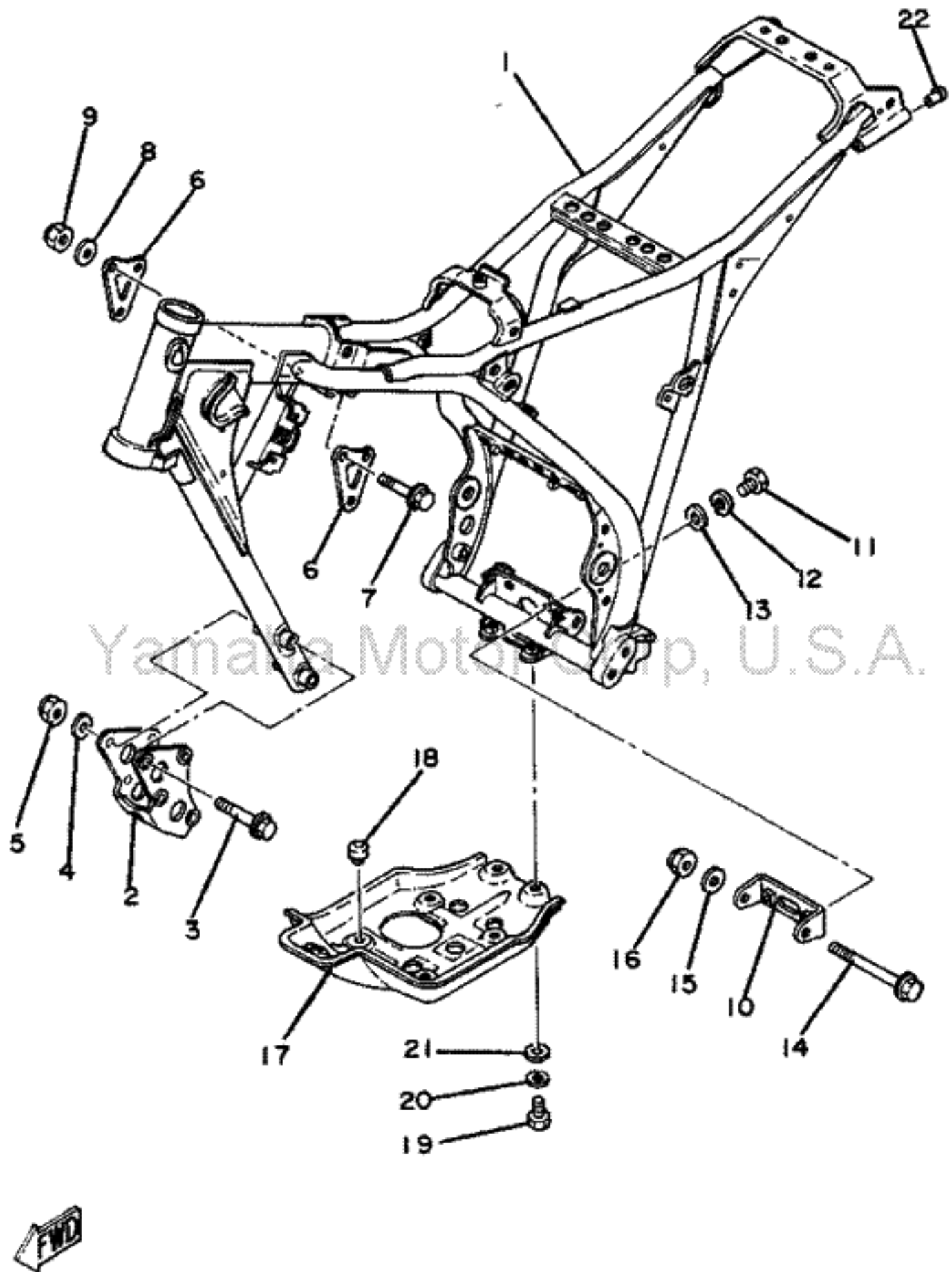



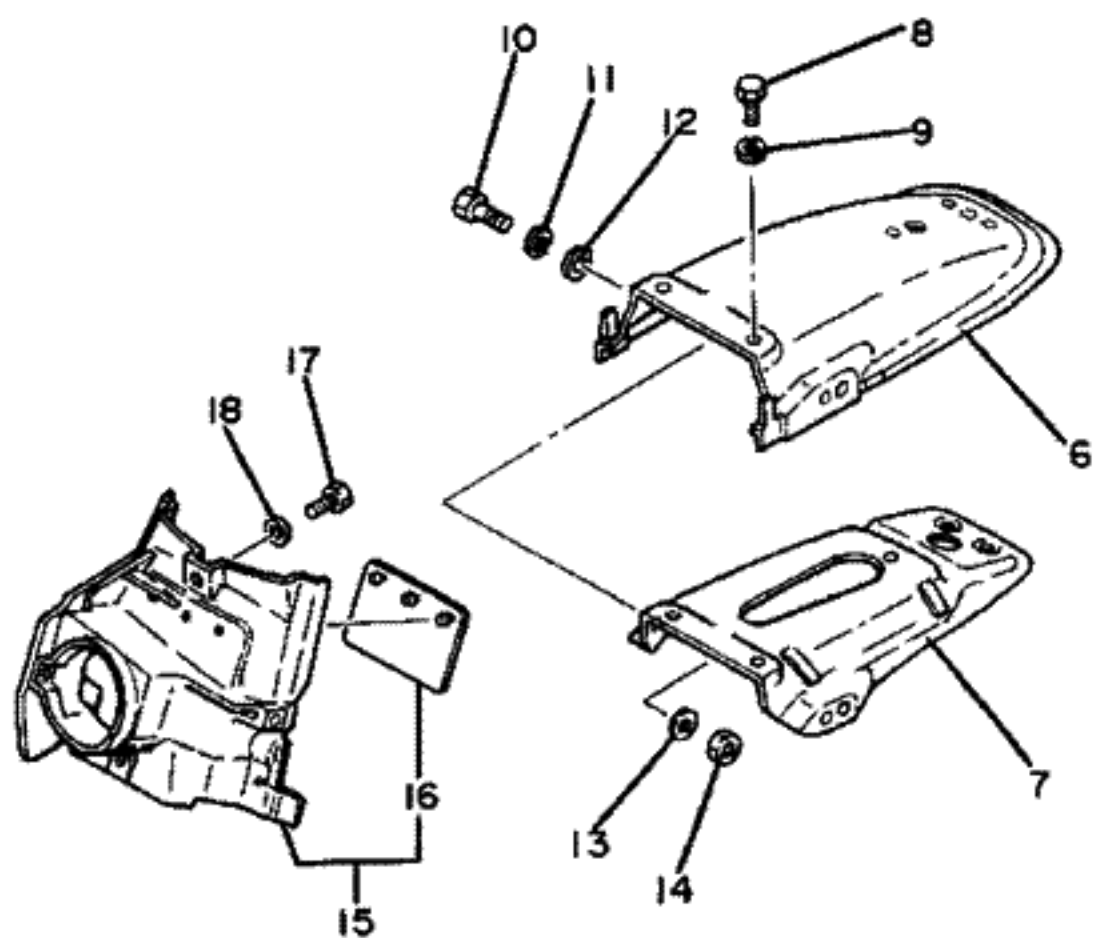



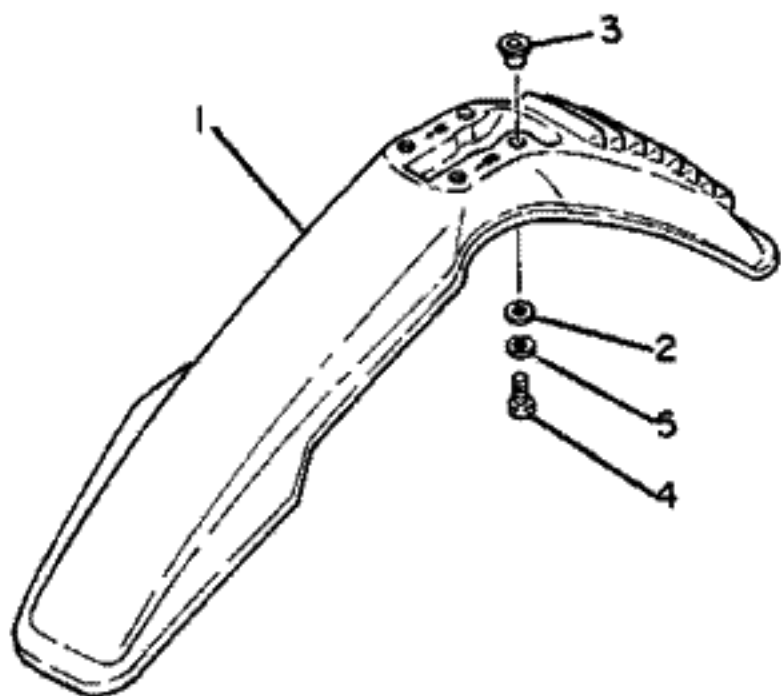











Item	Part #	Description	Notes	Req	
1	3Y1-21110-00-33	FRAME COMP	YAMAHA BLACK	1	ADD TO WISH LIST 
2	3Y1-21316-00-00	STAY, ENGINE 3		1	ADD TO WISH LIST 
3	95811-08070-00	BOLT, FLANGE		4	ADD TO WISH LIST 
4	90201-08366-00	WASHER, PLATE		4	ADD TO WISH LIST 
5	90185-08089-00	NUT, SELF-LOCKING		4	ADD TO WISH LIST 
6	3Y1-21315-00-00	STAY, ENGINE 2		2	ADD TO WISH LIST 
7	95812-08055-00	BOLT, FLANGE		3	ADD TO WISH LIST 
8	90201-08366-00	WASHER, PLATE		3	ADD TO WISH LIST 
9	90185-08089-00	NUT, SELF-LOCKING		3	ADD TO WISH LIST 
10	3Y1-21475-00-00	PLATE, ENGINE ADJUSTING		1	ADD TO WISH LIST 
11	97321-08016-00	BOLT (97322-08016)		2	ADD TO WISH LIST 
12	92903-08100-00	WASHER, SPRING (92902-08100)		2	ADD TO WISH LIST 
13	92901-08600-00	WASHER, PLATE (92902-08600)		2	ADD TO WISH LIST 
14	90105-08162-00	BOLT, WASHER BASED		1	ADD TO WISH LIST 
15	90201-08366-00	WSHER, PLATE		1	ADD TO WISH LIST 
16	90185-08089-00	NUT, SELF-LOCKING		1	ADD TO WISH LIST 
17	3Y1-21471-00-35	PROTECTOR, ENGINE	SILVER	1	ADD TO WISH LIST 
18	3Y1-24768-00-00	STOPPER		4	ADD TO WISH LIST 
19	97301-06016-00	BOLT (97301-06015)		3	ADD TO WISH LIST 
20	92903-06100-00	WASHER, SPRING (92902-06100)		3	ADD TO WISH LIST 
21	92901-06600-00	WASHER (92902-06600)		3	ADD TO WISH LIST 
22	3Y1-21279-00-00	PLUG, BLIND		2	ADD TO WISH LIST 





Yamaha Motor Corp, U.S.A.

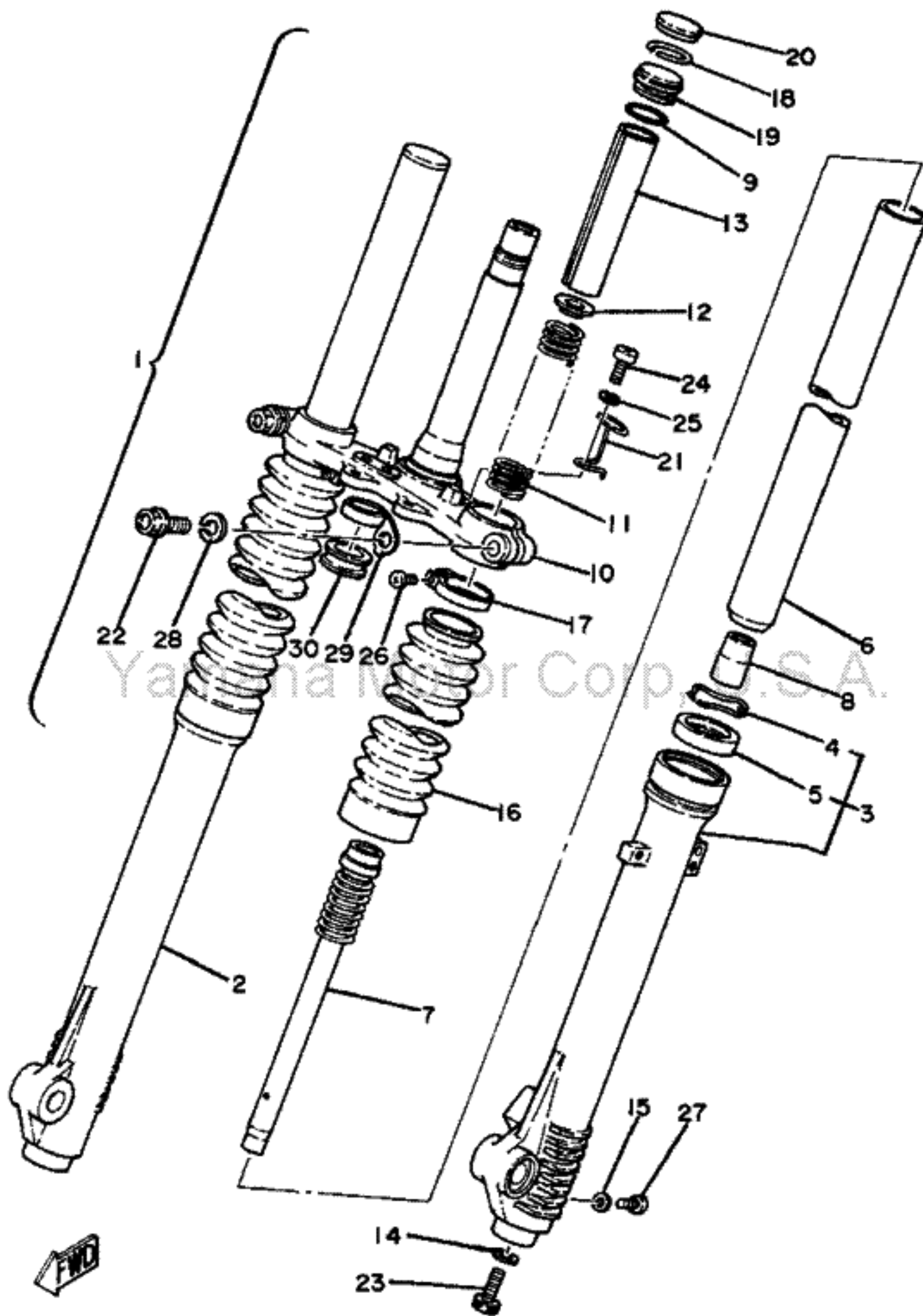

Item	Part #	Description	Notes	Req	
1	3Y1-21511-01-00	FENDER, FRONT	WHITE	1	ADD TO WISH LIST 
2	90201-06067-00	WASHER, PLATE		4	ADD TO WISH LIST 
3	90387-07789-00	COLLAR		4	ADD TO WISH LIST 
4	97301-06016-00	BOLT (97301-06015)		4	ADD TO WISH LIST 
5	92903-06100-00	WASHER, SPRING (92902-06100)		4	ADD TO WISH LIST 
6	3Y1-21611-00-00	FENDER, REAR	WHITE	1	ADD TO WISH LIST 
7	3Y1-21670-00-00	REINF. COMP		1	ADD TO WISH LIST 
8	97301-06016-00	BOLT (97301-06015)		2	ADD TO WISH LIST 
9	92903-06100-00	WASHER, SPRING (92902-06100)		2	ADD TO WISH LIST 
10	97301-08030-00	BOLT		2	ADD TO WISH LIST 
11	92903-08100-00	WASHER, SPRING (92901-08100)		2	ADD TO WISH LIST 
12	92901-08600-00	WASHER, PLATE		2	ADD TO WISH LIST 
13	90201-08100-00	WASHER, PLATE		2	ADD TO WISH LIST 
14	95301-08600-00	NUT (95302-08600)		2	ADD TO WISH LIST 
15	3Y1-21620-00-00	MUD GUARD COMP		1	ADD TO WISH LIST 
16	1M1-21621-00-00	FLAP		1	ADD TO WISH LIST 
17	97301-06016-00	BOLT (9730-06015)		2	ADD TO WISH LIST 
18	90201-06067-00	WASHER, PLATE		2	ADD TO WISH LIST 





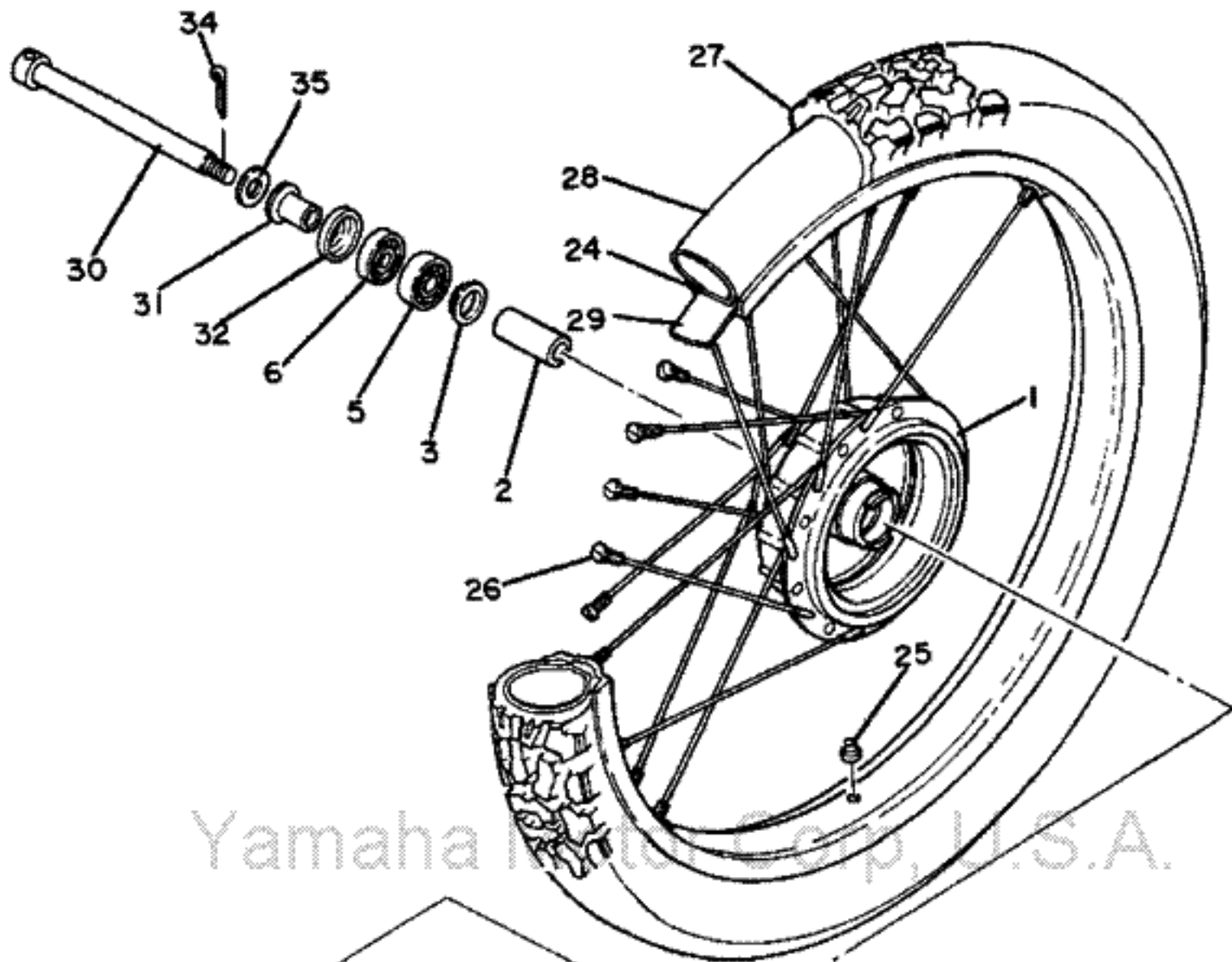



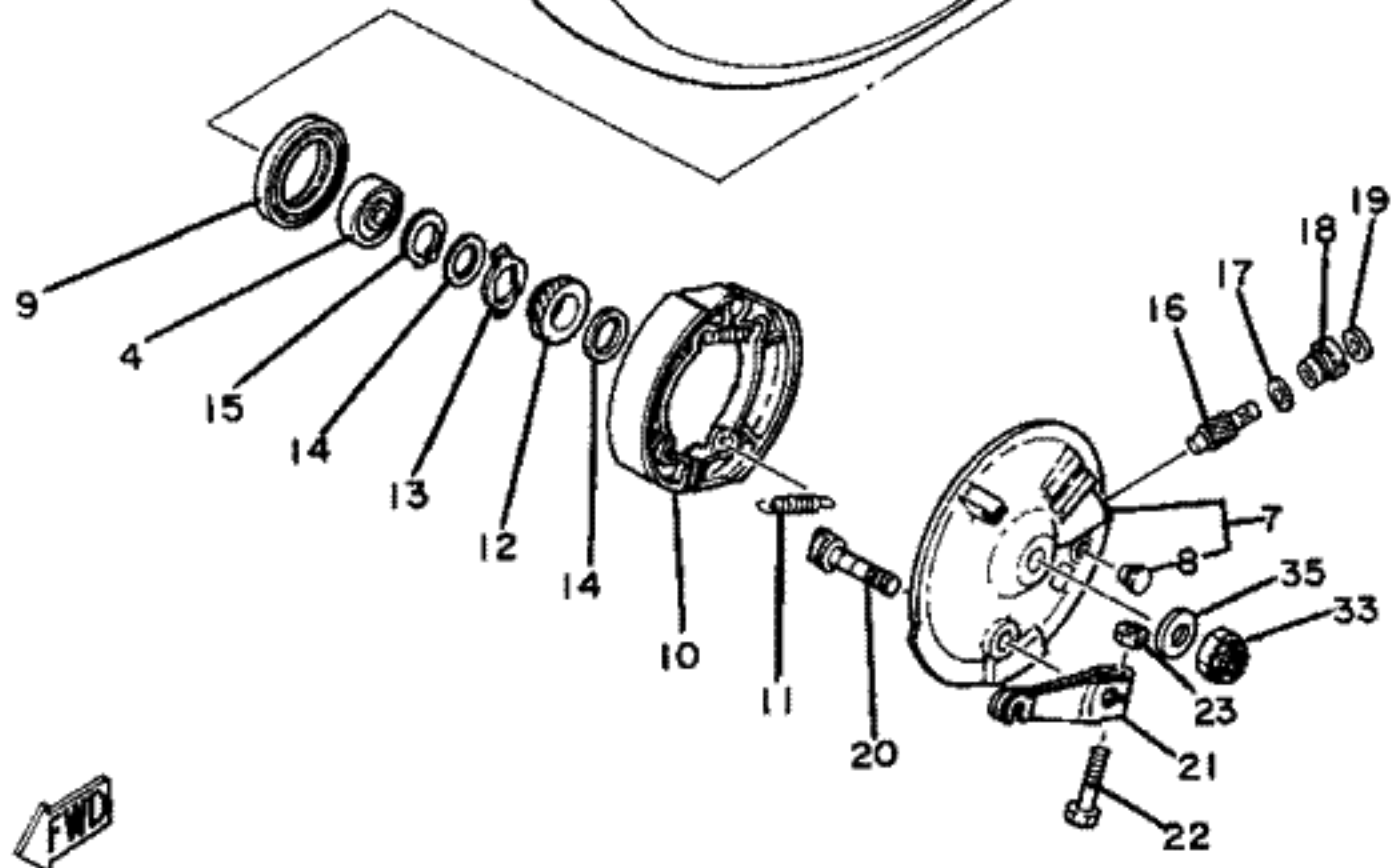



























Item	Part #	Description	Notes	Req	
1	3Y1-23100-00-00	FRONT FORK ASS'Y		1	ADD TO WISH LIST 
2	3Y1-23136-00-98	TUBE, OUTER 2	LOW GLOSS BLK	1	ADD TO WISH LIST 
3	3Y1-23126-00-98	TUBE, OUTER 1	LOW GLOSS BLK	1	ADD TO WISH LIST 
4	4A1-23156-00-00	CLIP, OIL SEAL		2	ADD TO WISH LIST 
5	1T3-23145-00-00	OIL SEAL		2	ADD TO WISH LIST 
6	3Y1-23110-00-00	INNER TUBE COMP. 1		2	ADD TO WISH LIST 
7	3Y1-23170-00-00	CYLINDER COMP., FRONT FORK		2	ADD TO WISH LIST 
8	1W1-23173-L0-00	SPINDLE, TAPER		2	ADD TO WISH LIST 
9	3J2-23114-00-00	O-RING		2	ADD TO WISH LIST 
10	3Y1-23340-00-33	UNDERBRACKET COMP	YAMAHA BLACK	1	ADD TO WISH LIST 
11	3Y1-23141-00-00	SPRING, FRONT FORK		2	ADD TO WISH LIST 
12	583-23142-00-00	SEAT, SPRING UPPER		2	ADD TO WISH LIST 
13	2W6-23118-00-00	SPACER		2	ADD TO WISH LIST 
14	509-23158-L0-00	GASKET		2	ADD TO WISH LIST 
15	122-23129-00-00	GASKET, DRAIN PLUG		2	ADD TO WISH LIST 
16	3Y1-23191-00-00	BOOT		2	ADD TO WISH LIST 
17	341-92090-60-00	BAN D, BOOT		2	ADD TO WISH LIST 
18	3J2-23183-00-00	CIRCLIP		2	ADD TO WISH LIST 
19	3Y1-23111-00-00	BOLT, CAP		2	ADD TO WISH LIST 
20	3Y1-23168-00-00	CAP, FRONT FORK		2	ADD TO WISH LIST 
21	3Y1-2331E-00-00	GUIDE, CABLE		1	ADD TO WISH LIST 
22	3Y1-23346-00-00	BOLT 1		2	ADD TO WISH LIST 
23	278-23181-50-00	BOLT, HEXAGON SOCKET HEAD		2	ADD TO WISH LIST 
24	92503-06012-00	SCREW, PAN HEAD (92501-06012)		1	ADD TO WISH LIST 
25	92903-06100-00	WASH ER, SPRING (92901-06100)		1	ADD TO WISH LIST 
26	509-23194-L0-00	SCREW, BOOT BAND		2	ADD TO WISH LIST 
27	98501-04008-00	PLUG, DRAIN (122-23119-01)		2	ADD TO WISH LIST 
28	92901-12100-00	WASHER, SPRING		2	ADD TO WISH LIST 
29	3Y1-23317-00-00	HOLDER, CABLE		1	ADD TO WISH LIST 
30	1W1-23389-00-00	GUIDE, CABLE		1	ADD TO WISH LIST 



Yamaha Motor Corp., U.S.A.



Item	Part #	Description	Notes	Req	
1	3Y1-25111-00-98	HUB, FRONT	LOW GLOSS BLK	1	ADD TO WISH LIST 
2	214-25117-00-00	SPACER, BEARING		1	ADD TO WISH LIST 
3	183-25315-00-00	FLANGE, SPACER		1	ADD TO WISH LIST 
4	93306-20203-00	BEARING (B6202RS)		1	ADD TO WISH LIST 
5	93306-20205-00	BEARING (B6202)		1	ADD TO WISH LIST 
6	93102-20009-00	OIL SEAL		1	ADD TO WISH LIST 
7	3Y1-25016-00-98	BRAKE SHOE PLATE ASS'Y	LOW GLOSS BLK	1	ADD TO WISH LIST 
8	90480-10068-00	GROMMET		1	ADD TO WISH LIST 
9	93105-47007-00	OIL SEAL		1	ADD TO WISH LIST 
10	3Y1-25330-00-00	BRAKE SHOE COMP		2	ADD TO WISH LIST 
11	90506-16036-00	SPRING, TENSION		2	ADD TO WISH LIST 
12	308-25135-00-00	GEAR, DRIVE (10T)		1	ADD TO WISH LIST 
13	214-25149-01-00	CLUTCH, METER		1	ADD TO WISH LIST 
14	90201-22283-00	WASHER, PLATE		2	ADD TO WISH LIST 
15	93410-22014-00	CIRCLIP		1	ADD TO WISH LIST 
16	308-25138-00-00	GEAR, METER (10T)		1	ADD TO WISH LIST 
17	90201-07076-00	WASHER, PLATE		1	ADD TO WISH LIST 
18	109-25136-00-00	BUSH		1	ADD TO WISH LIST 
19	93104-07003-00	OILSEAL		1	ADD TO WISH LIST 
20	538-25351-01-00	CAMSHAFT		1	ADD TO WISH LIST 
21	3Y1-25155-00-00	LEVER, CAMSHAFT 1		1	ADD TO WISH LIST 
22	90101-06278-00	BOLT			ADD TO WISH LIST 
23	95301-06600-00	NUT 1			ADD TO WISH LIST 
24	94416-21241-00	RIM (1.60-21)		1	ADD TO WISH LIST 
25	90480-10068-00	GROMMET,		1	ADD TO WISH LIST 
26	3Y1-25104-00-00	SPOKE SET, FRONT		1	ADD TO WISH LIST 
27	94130-21416-00	TIRE (3.00-21)		1	ADD TO WISH LIST 
28	94227-21123-00	TUBE (2.75-21)		1	ADD TO WISH LIST 
29	94330-21084-00	BAND, RIM (3.00-21)		1	ADD TO WISH LIST 
30	403-25381-01-00	AXLE, WHEEL		1	ADD TO WISH LIST 
31	90387-15600-00	COLLAR		1	ADD TO WISH LIST 
32	322-25118-00-00	COVER, HUB DUST		1	ADD TO WISH LIST 
33	90171-14020-00	NUT, CASTLE		1	ADD TO WISH LIST 
34	91401-30030-00	PIN, COTTER		1	ADD TO WISH LIST 
35	90201-15785-00	WASHER, PLATE		2	ADD TO WISH LIST 

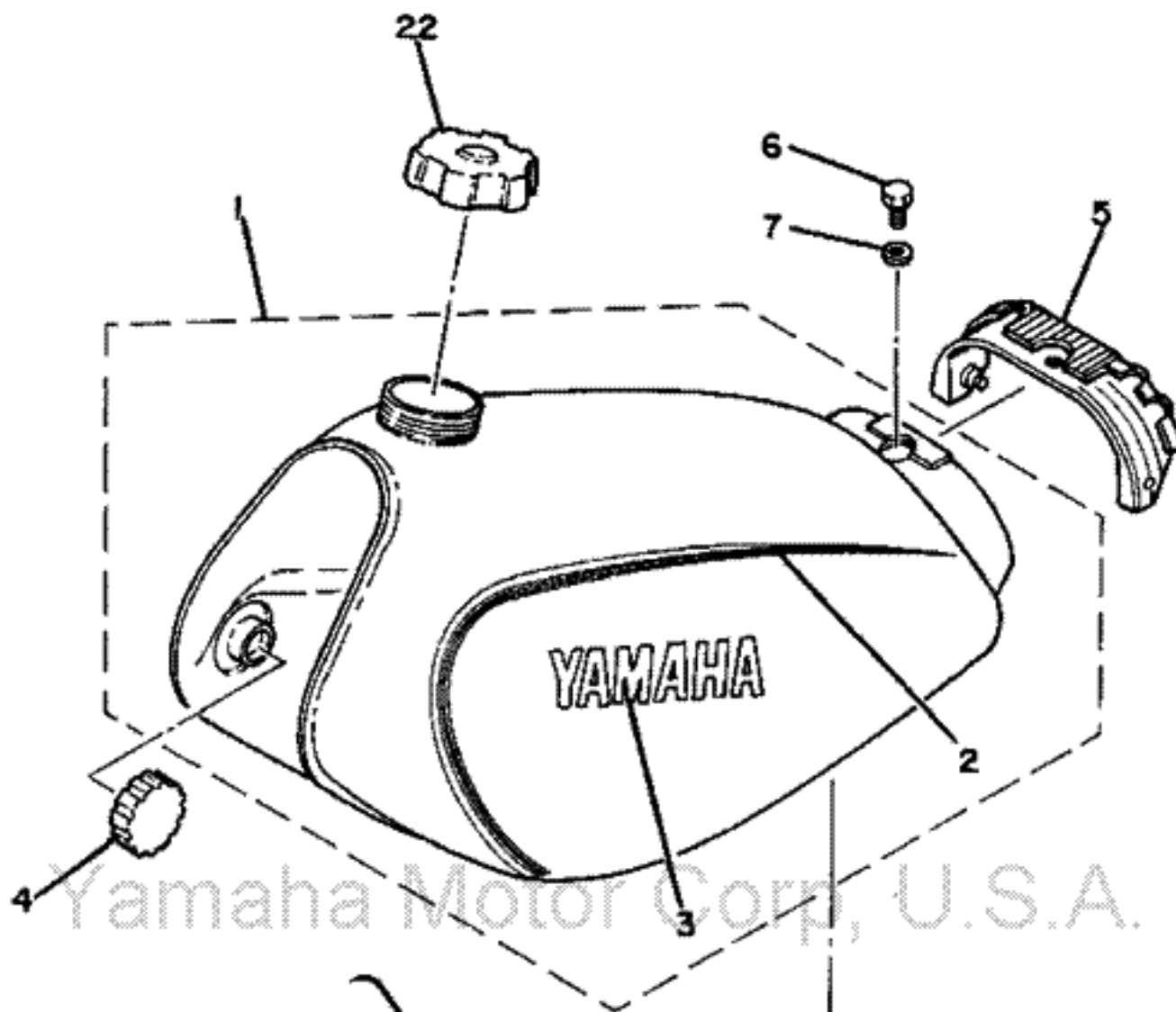

Yamaha Motor Corp, U.S.A.

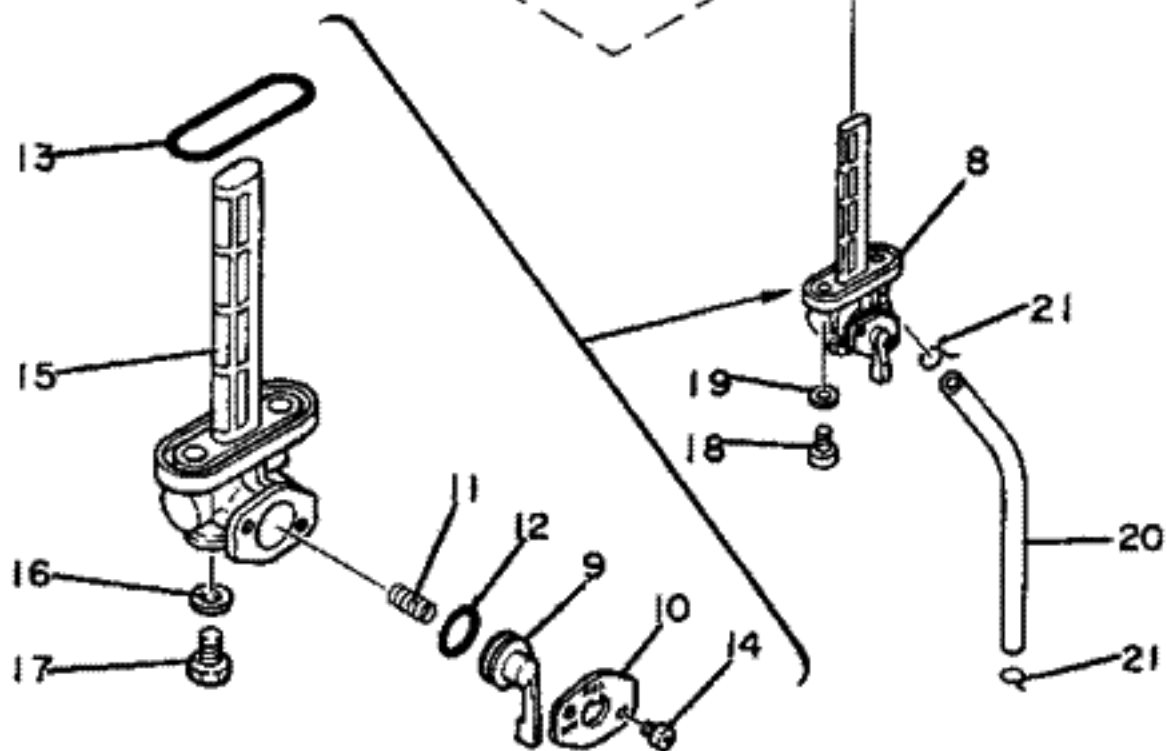



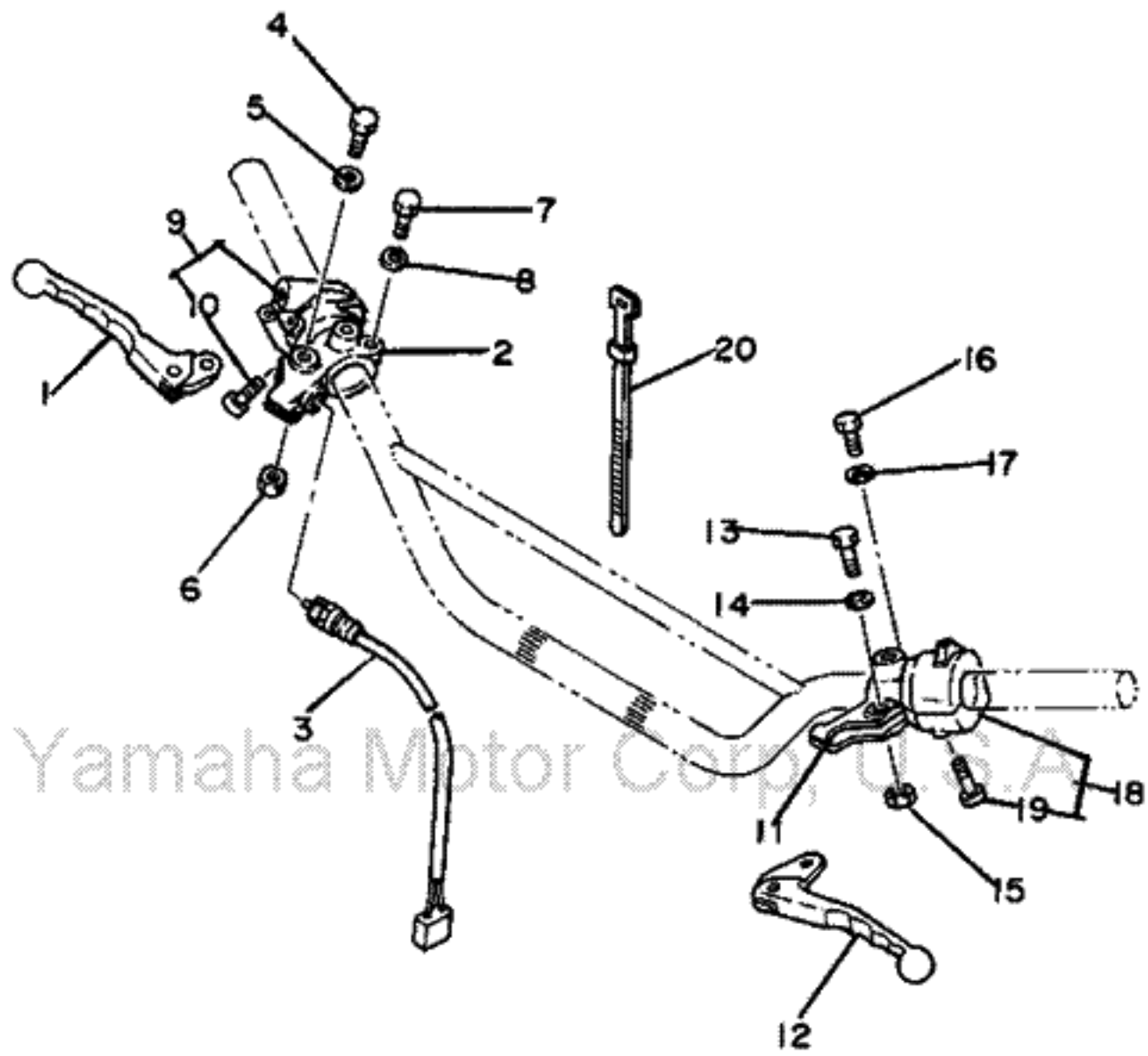



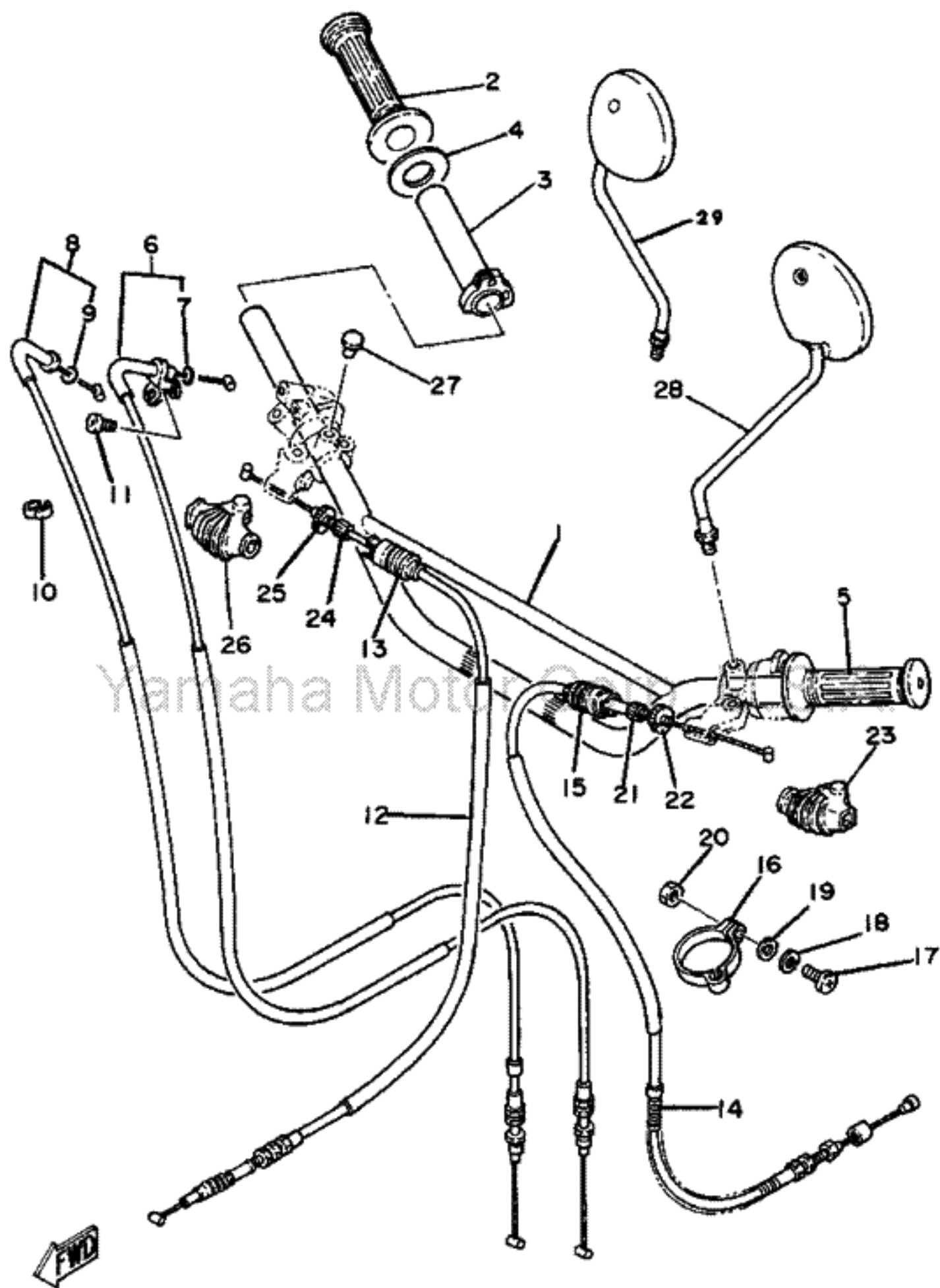





















Item	Part #	Description	Notes	Req	
1	3Y1-24110-00-08	FUEL TANK COMP	U.R. BRILLIANT RED	1	ADD TO WISH LIST 
1	3Y1-24110-00-07	FUEL TANK COMP	U.R. CRYSTAL SILVER	1	ADD TO WISH LIST 
2	3Y1-24240-20-00	GRAPHIC SET		1	ADD TO WISH LIST 
3	2J0-24161-20-00	EMBLEM 1		2	ADD TO WISH LIST 
4	278-24181-00-00	DAMPER, LOCATING 1		2	ADD TO WISH LIST 
5	3Y1-24182-01-00	DAMPER, LOCATING 2		1	ADD TO WISH LIST 
6	97301-06014-00	BOLT (97302-06014)		1	ADD TO WISH LIST 
7	90201-06063-00	WASHER, PLATE		1	ADD TO WISH LIST 
8	3Y1-24500-00-00	FUEL COCK ASS'Y 1		1	ADD TO WISH LIST 
9	3Y1-24524-00-00	LEVER, COCK		1	ADD TO WISH LIST 
10	3Y1-24525-00-00	PLATE, LEVER FITTING		1	ADD TO WISH LIST 
11	2W6-24529-00-00	SPRING		1	ADD TO WISH LIST 
12	2N3-24528-00-00	O-RING		1	ADD TO WISH LIST 
13	3H3-24512-00-00	O-RING, FUEL COCK		1	ADD TO WISH LIST 
14	98501-03008-00	SCREW, PAN HEAD		2	ADD TO WISH LIST 
15	3Y1-24514-00-00	NET, FILTER 1		1	ADD TO WISH LIST 
16	2G2-24522-00-00	GASKET		1	ADD TO WISH LIST 
17	2G2-24543-00-00	PLUG, DRAIN		1	ADD TO WISH LIST 
18	90149-06011-00	SCREW		2	ADD TO WISH LIST 
19	90202-06010-00	WASHER, PLATE		2	ADD TO WISH LIST 
20	90445-10458-00	HOSE		1	ADD TO WISH LIST 
21	90467-09006-00	CLIP		2	ADD TO WISH LIST 
22	3Y1-24610-01-00	CAP ASS'Y (3Y1-24610-00)		1	ADD TO WISH LIST 



Item	Part #	Description	Notes	Req	
1	2H0-83922-20-00	LEVER 2	LOW GLOSS BLK	1	ADD TO WISH LIST 
2	361-82920-93-00	HOLDER, LEVER 2 (361-82921-91)		1	ADD TO WISH LIST 
3	1M1-83980-30-00	FRONT STOP SWITCH ASSY		1	ADD TO WISH LIST 
4	90109-06410-00	BOLT		1	ADD TO WISH LIST 
5	90201-08083-00	WASHER, PLATE		1	ADD TO WISH LIST 
6	95601-06100-00	NUT, U		1	ADD TO WISH LIST 
7	97301-06022-00	BOLT		1	ADD TO WISH LIST 
8	92903-06100-00	WASHER, SPRING (92901-06100)		1	ADD TO WISH LIST 
9	3Y1-83976-00-00	SWITCH, HANDLE 1		1	ADD TO WISH LIST 
10	98503-05020-00	SCREW, PAN HEAD (98501-05020)		2	ADD TO WISH LIST 
11	498-82911-00-00	HOLDER, LEVER 1		1	ADD TO WISH LIST 
12	2H0-83912-20-00	LEVER 1	LOW GLOSS BLK	1	ADD TO WISH LIST 
13	90109-06410-00	BOLT		1	ADD TO WISH LIST 
14	90201-08083-00	WASHER, PLATE		1	ADD TO WISH LIST 
15	95601-06100-00	NUT, U		1	ADD TO WISH LIST 
16	97301-06022-00	BOLT		1	ADD TO WISH LIST 
17	92903-06100-00	WASHER, SPRING (92901-06100)		1	ADD TO WISH LIST 
18	1M1-83973-50-00	SWITCH, HANDLE 3		1	ADD TO WISH LIST 
19	98503-05020-00	SCREW, PAN HEAD (98501-05020)		2	ADD TO WISH LIST 
20	437-83936-00-00	BAND, SWITCH CORD		4	ADD TO WISH LIST 





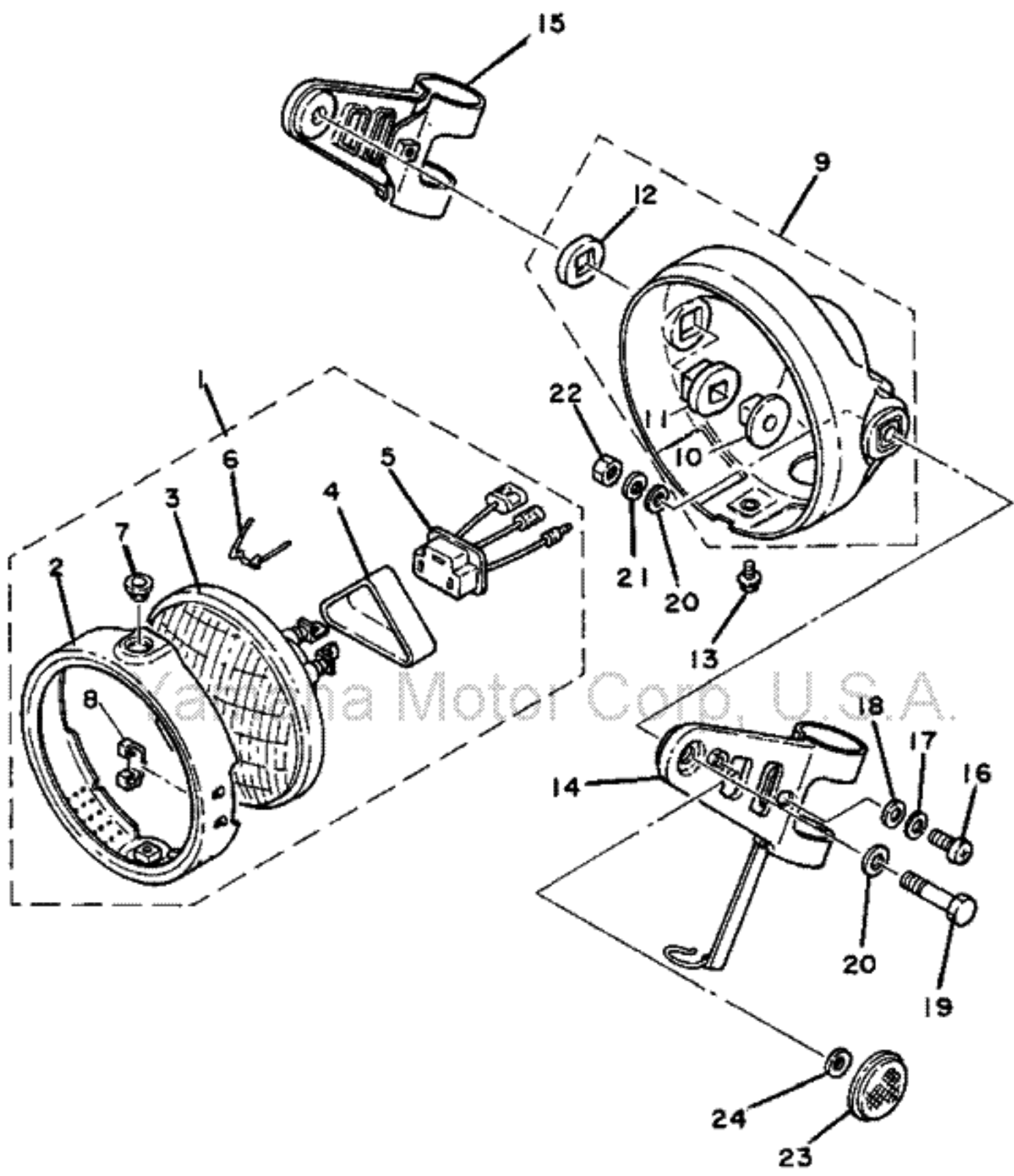



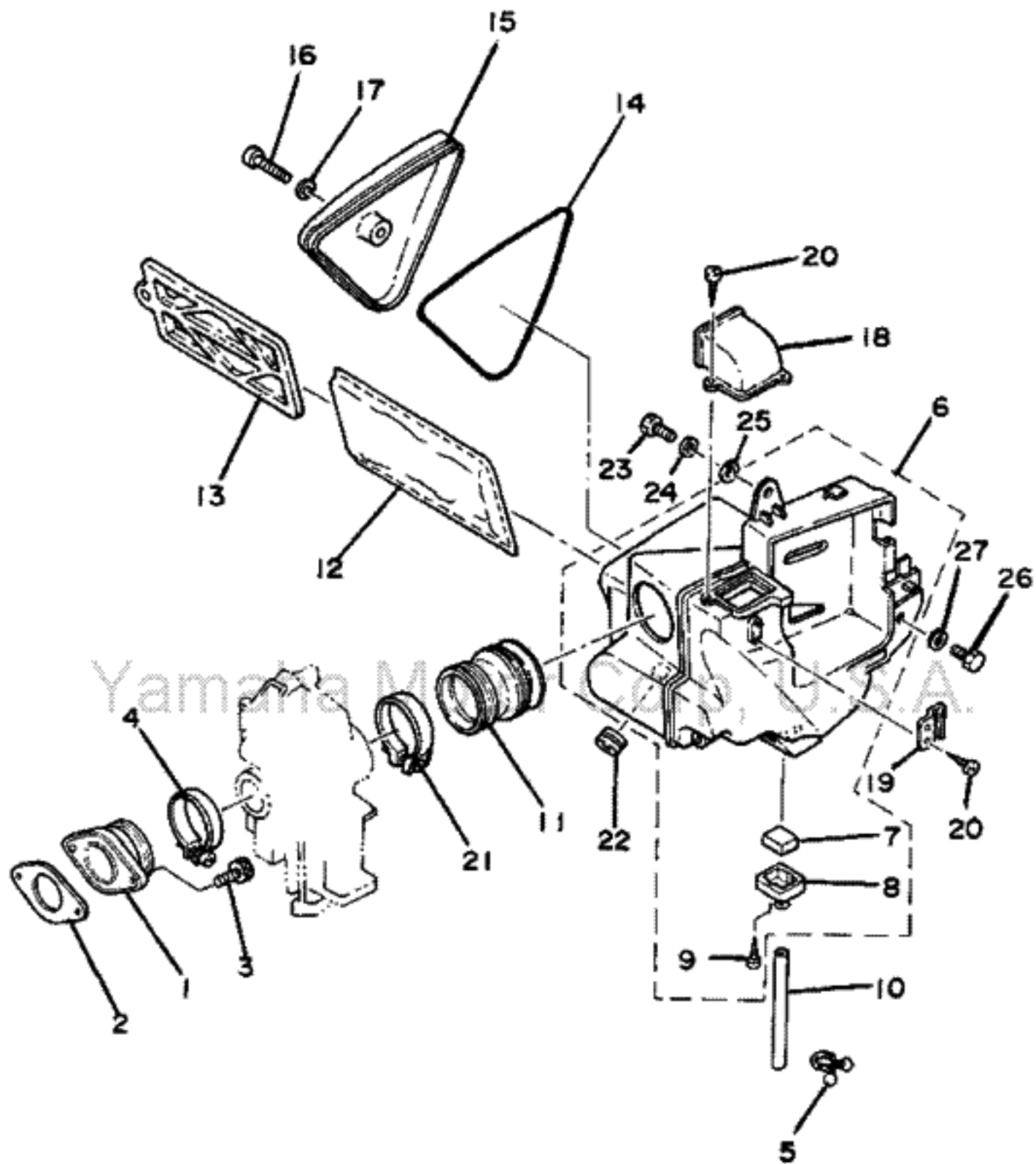



















Item	Part #	Description	Notes	Req	
1	3Y1-26111-00-00	HANDLEBAR		1	ADD TO WISH LIST 
2	1A0-26242-01-00	GRIP (R.H.)		1	ADD TO WISH LIST 
3	3Y1-26243-00-00	TUBE, THROTTLE GUIDE		1	ADD TO WISH LIST 
4	3Y1-26249-00-00	RING, LEAF		1	ADD TO WISH LIST 
5	1E6-26241-00-00	GRIP (L.H.)		1	ADD TO WISH LIST 
6	3Y1-26311-00-00	CABLE, THROTTLE 1		1	ADD TO WISH LIST 
7	93210-08408-00	O-RING		1	ADD TO WISH LIST 
8	3Y1-26312-00-00	CABLE, THROTTLE 2		1	ADD TO WISH LIST 
9	93210-08408-00	O-RING		1	ADD TO WISH LIST 
10	90468-15009-00	CLIP		1	ADD TO WISH LIST 
11	98506-05008-00	SCREW, PAN HEAD		1	ADD TO WISH LIST 
12	3Y1-26341-00-00	CABLE, BRAKE		1	ADD TO WISH LIST 
13	1E6-26342-00-00	BOOT, CABLE		1	ADD TO WISH LIST 
14	3Y0-26335-00-00	CABLE, CLUTCH		1	ADD TO WISH LIST 
15	1E6-26342-00-00	BOOT, CABLE		1	ADD TO WISH LIST 
16	3Y1-26397-00-00	BAND		1	ADD TO WISH LIST 
17	98501-05016-00	SCREW, PAN HEAD		1	ADD TO WISH LIST 
18	92903-05100-00	WASHER, SPRING (92901-05100)		1	ADD TO WISH LIST 
19	92901-05600-00	WASHER, PLATE		1	ADD TO WISH LIST 
20	95301-05600-00	NUT		1	ADD TO WISH LIST 
21	90123-08046-00	BOLT		1	ADD TO WISH LIST 
22	90179-08148-00	NUT		1	ADD TO WISH LIST 
23	1E6-26372-00-00	COVER, HANDLE LEVER		1	ADD TO WISH LIST 
24	90123-08046-00	BOLT		1	ADD TO WISH LIST 
25	90179-08148-00	NUT		1	ADD TO WISH LIST 
26	1E6-26372-00-00	COVER, HANDLE LEVER		1	ADD TO WISH LIST 
27	90338-09012-00	PLUG		1	ADD TO WISH LIST 
28	3Y1-26290-10-00	MIRROR ASS'Y		1	ADD TO WISH LIST 
29	3Y1-26290-00-00	MIRROR ASS'Y (R.H.)	ALTERNATE PART	1	ADD TO WISH LIST 









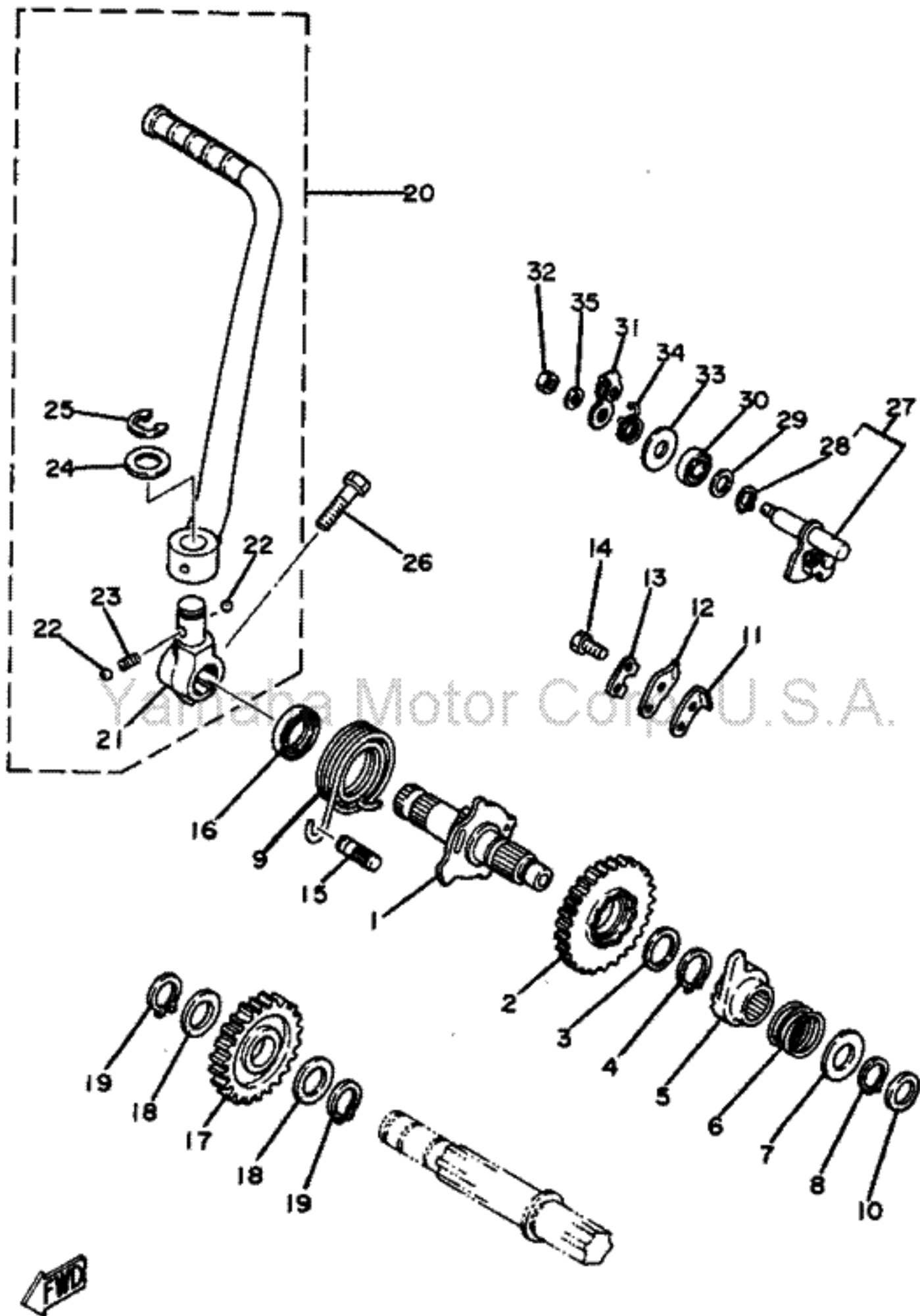

















Item	Part #	Description	Notes	Req	
1	3J0-84110-60-00	HEADLIGHT UNIT ASS'Y	N/A	1	ADD TO WISH LIST 
2	3J0-84195-60-00	RING, RETAINING		1	ADD TO WISH LIST 
3	2A6-84120-60-00	LENS ASS'Y		1	ADD TO WISH LIST 
4	341-84397-61-00	COVER, SOCKET		1	ADD TO WISH LIST 
5	371-84312-60-00	SOCKET		1	ADD TO WISH LIST 
6	1M1-84124-60-00	SPRING, SET		3	ADD TO WISH LIST 
7	1M1-84133-60-00	COLLAR, SCREW		1	ADD TO WISH LIST 
8	498-84128-60-00	COVER, FITTING		1	ADD TO WISH LIST 
9	3J0-84130-60-00	BODY ASS'Y, HEADLIGHT	BLACK	1	ADD TO WISH LIST 
10	498-84145-60-00	COLLAR, BODY FITTING		2	ADD TO WISH LIST 
11	498-84163-60-00	DAMPER		2	ADD TO WISH LIST 
12	1M1-84164-60-00	DAMPER		2	ADD TO WISH LIST 
13	1M1-84137-60-00	BOLT, SPECIAL		1	ADD TO WISH LIST 
14	3Y1-84118-01-00	STAY, HEADLIGHT 1		1	ADD TO WISH LIST 
15	3Y1-84119-01-00	STAY, HEADLIGHT 2		1	ADD TO WISH LIST 
16	92506-06018-00	SCREW, PAN HEAD		2	ADD TO WISH LIST 
17	92906-06100-00	WASHER, SPRING		2	ADD TO WISH LIST 
18	92906-06600-00	WASHER, PLATE		2	ADD TO WISH LIST 
19	97301-08040-00	BOLT		2	ADD TO WISH LIST 
20	92903-08200-00	WASHER, PLAIN (92901-08200)		4	ADD TO WISH LIST 
21	92903-08100-00	WASHER, SPRING (92902-08100)		2	ADD TO WISH LIST 
22	95301-08600-00	NUT (95302-08600)		2	ADD TO WISH LIST 
23	2N8-85111-00-00	REFLECTOR, FRONT 1		2	ADD TO WISH LIST 
24	90430-06012-00	GASKET		2	ADD TO WISH LIST 









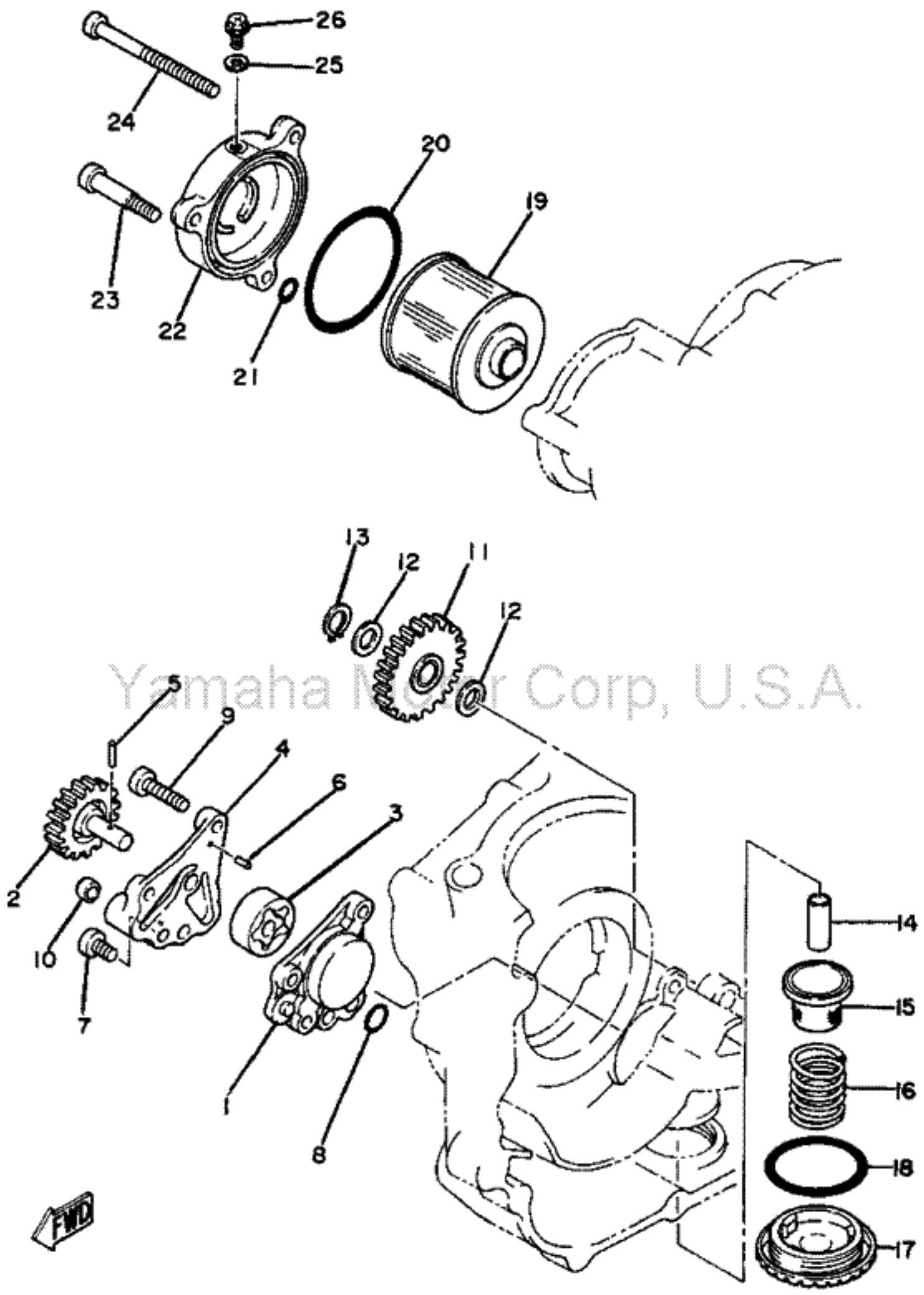





















Item	Part #	Description	Notes	Req	
1	3Y1-13586-00-00	JOINT, CARBURETOR 1		1	ADD TO WISH LIST 
2	3Y1-13556-01-00	GASKET, MANIFOLD		1	ADD TO WISH LIST 
3	91316-06020-00	BOLT		2	ADD TO WISH LIST 
4	90460-49160-00	CLAMP, HOSE		1	ADD TO WISH LIST 
5	90464-16039-00	CLAMP		1	ADD TO WISH LIST 
6	3Y1-14401-01-00	AIR CLEANER CASE ASS'Y		1	ADD TO WISH LIST 
7	3Y1-14462-00-00	SEAL		1	ADD TO WISH LIST 
8	3Y1-14419-00-00	PIPE		1	ADD TO WISH LIST 
9	97701-30520-00	SCREW, PAN HEAD TAPPING		2	ADD TO WISH LIST 
10	90446-11021-00	HOSE		1	ADD TO WISH LIST 
11	3Y1-14453-00-00	JOINT, AIR CLEANER 1		1	ADD TO WISH LIST 
12	3Y1-14451-00-00	ELEMENT, AIR CLEANER		1	ADD TO WISH LIST 
13	3Y1-14458-00-00	GUIDE		1	ADD TO WISH LIST 
14	93211-05393-00	O-RING		1	ADD TO WISH LIST 
15	3Y1-14412-00-00	CAP, CLEANER CASE 1		1	ADD TO WISH LIST 
16	92506-06035-00	SCREW, PAN HEAD		1	ADD TO WISH LIST 
17	92906-06600-00	WASHER, PLATE		1	ADD TO WISH LIST 
18	3Y1-14431-00-00	SILENCER, INTAKE 1		1	ADD TO WISH LIST 
19	3Y1-2175R-00-00	HOOK, BANK		1	ADD TO WISH LIST 
20	97701-40508-00	SCREW, TAPPING		4	ADD TO WISH LIST 
21	90460-54085-00	CLAMP, HOSE		1	ADD TO WISH LIST 
22	90480-16265-00	GROMMET		1	ADD TO WISH LIST 
23	97301-06016-00	BOLT (97301-06015)		1	ADD TO WISH LIST 
24	90201-06067-00	WASHER, PLATE		1	ADD TO WISH LIST 
25	90202-06013-00	WASHER, PLATE		1	ADD TO WISH LIST 
26	97301-06016-00	BOLT (97301-06015)		1	ADD TO WISH LIST 
27	92901-06600-00	WASHER (92902-06600)		1	ADD TO WISH LIST 



Item	Part #	Description	Notes	Req	
1	3Y1-15660-00-00	KICK AXLE ASS'Y		1	ADD TO WISH LIST 
2	3Y1-15641-00-00	GEAR, KICK (30T)		1	ADD TO WISH LIST 
3	90201-20685-00	WASHER, PLATE		1	ADD TO WISH LIST 
4	93410-20038-00	CIRCLIP		1	ADD TO WISH LIST 
5	3Y1-15671-00-00	WHEEL, RATCHET		1	ADD TO WISH LIST 
6	90501-16107-00	SPRING, COMPRESSION		1	ADD TO WISH LIST 
7	168-15676-00-00	COVER, SPRING		1	ADD TO WISH LIST 
8	93410-15005-00	CIRCLIP		1	ADD TO WISH LIST 
9	90508-32432-00	SPRING, TORSION		1	ADD TO WISH LIST 
10	90201-15701-00	WASHER, PLATE (1.0T)		1	ADD TO WISH LIST 
11	2K7-15668-00-00	STOPPER		1	ADD TO WISH LIST 
12	214-15674-00-00	GUIDE, RATCHET WHEEL		1	ADD TO WISH LIST 
13	214-15686-00-00	WASHER, LOCK		1	ADD TO WISH LIST 
14	97321-06016-00	BOLT		2	ADD TO WISH LIST 
15	248-15668-00-00	STOPPER		1	ADD TO WISH LIST 
16	93102-20108-00	OIL SEAL		1	ADD TO WISH LIST 
16	93102-20108-00	OIL SEAL		1	ADD TO WISH LIST 
17	3Y1-15651-00-00	GEAR, KICK IDLE (27T)		1	ADD TO WISH LIST 
18	90201-20276-00	WASHER, PLATE		2	ADD TO WISH LIST 
19	93410-20009-00	CIRCLIP		2	ADD TO WISH LIST 
20	3Y1-15620-01-00	KICK CRANK ASS'Y		1	ADD TO WISH LIST 
21	3Y1-15621-01-00	BOSS, KICK CRANK		1	ADD TO WISH LIST 
22	93507-32009-00	BALL		2	ADD TO WISH LIST 
23	90501-10589-00	SPRING, COMPRESSION		1	ADD TO WISH LIST 
24	90201-15340-00	WASHER, PLATE		1	ADD TO WISH LIST 
25	93430-10016-00	CIRCLIP		1	ADD TO WISH LIST 
26	97311-08030-00	BOLT		1	ADD TO WISH LIST 
27	3Y1-1561A-01-00	LEVER DECOMP. ASS'Y		1	ADD TO WISH LIST 
28	93410-10025-00	CIRCLIP		1	ADD TO WISH LIST 
29	90201-10644-00	WASHER, PLATE		1	ADD TO WISH LIST 
30	93102-10207-00	OIL SEAL		1	ADD TO WISH LIST 
31	3Y1-1561G-01-00	LEVER, CABLE		1	ADD TO WISH LIST 
32	95311-06700-00	NUT		1	ADD TO WISH LIST 
33	90201-10135-00	WASHER, PLATE		1	ADD TO WISH LIST 
34	90508-14436-00	SPRING, TORSION		1	ADD TO WISH LIST 
35	92901-06600-00	WASHER, PLATE		1	ADD TO WISH LIST 



Item	Part #	Description	Notes	Req	
1	3Y1-13336-00-00	HOUSING ROTOR	-110279	1	ADD TO WISH LIST 
1	3Y1-13336-01-00	HOUSING ROTOR	110280 - SEE NOTE	1	ADD TO WISH LIST 
2	3Y6-13326-00-00	GEAR, PUMP DRIVEN 2 (14T)	-110279	1	ADD TO WISH LIST 
2	3Y6-13326-01-00	GEAR, PUMP DRIVEN 2 (14T)	110280 - SEE NOTE	1	ADD TO WISH LIST 
3	3Y1-13310-00-00	ROTOR ASS'Y 1	-110279	1	ADD TO WISH LIST 
3	3Y1-13310-01-00	ROTOR ASS'Y 1	110280 - SEE NOTE	1	ADD TO WISH LIST 
4	3Y1-13316-00-00	COVER, PUMP		1	ADD TO WISH LIST 
5	93603-12030-00	PIN, DOWEL		1	ADD TO WISH LIST 
6	93603-07073-00	PIN, DOWEL		2	ADD TO WISH LIST 
7	92503-06015-00	SCREW, PAN HEAD (92501-06015)		1	ADD TO WISH LIST 
8	93210-10096-00	O-RING		1	ADD TO WISH LIST 
9	92501-06025-00	SCREW, PAN HEAD		3	ADD TO WISH LIST 
10	90430-06156-00	GASKET		1	ADD TO WISH LIST 
11	3Y1-13341-00-00	GEAR, OIL PUMP IDLE (20T)		1	ADD TO WISH LIST 
12	90201-10119-00	WASHER, PLATE		2	ADD TO WISH LIST 
13	93410-10025-00	CIRCLIP		1	ADD TO WISH LIST 
14	3Y1-13416-00-00	PIPE, OIL 1		1	ADD TO WISH LIST 
15	3Y1-13411-00-00	STRAINER, OIL		1	ADD TO WISH LIST 
16	90501-18576-00	SPRING, COMPRESSION		1	ADD TO WISH LIST 
17	3Y1-15351-01-00	PLUG, DRAIN		1	ADD TO WISH LIST 
18	93210-40351-00	O-RING		1	ADD TO WISH LIST 
19	2H0-13440-90-00	ELEMENT ASS'Y, OIL CLEANER		1	ADD TO WISH LIST 
20	93210-64297-00	O-RING		1	ADD TO WISH LIST 
21	93210-07155-00	O-RING (93210-07135)		1	ADD TO WISH LIST 
22	583-13447-00-00	COVER, OIL ELEMENT		1	ADD TO WISH LIST 
23	90109-06419-00	BOLT		1	ADD TO WISH LIST 
24	92506-06075-00	SCREW, PAN HEAD		2	ADD TO WISH LIST 
25	90430-05126-00	GASKET		1	ADD TO WISH LIST 
26	90149-05110-00	SCREW		1	ADD TO WISH LIST 



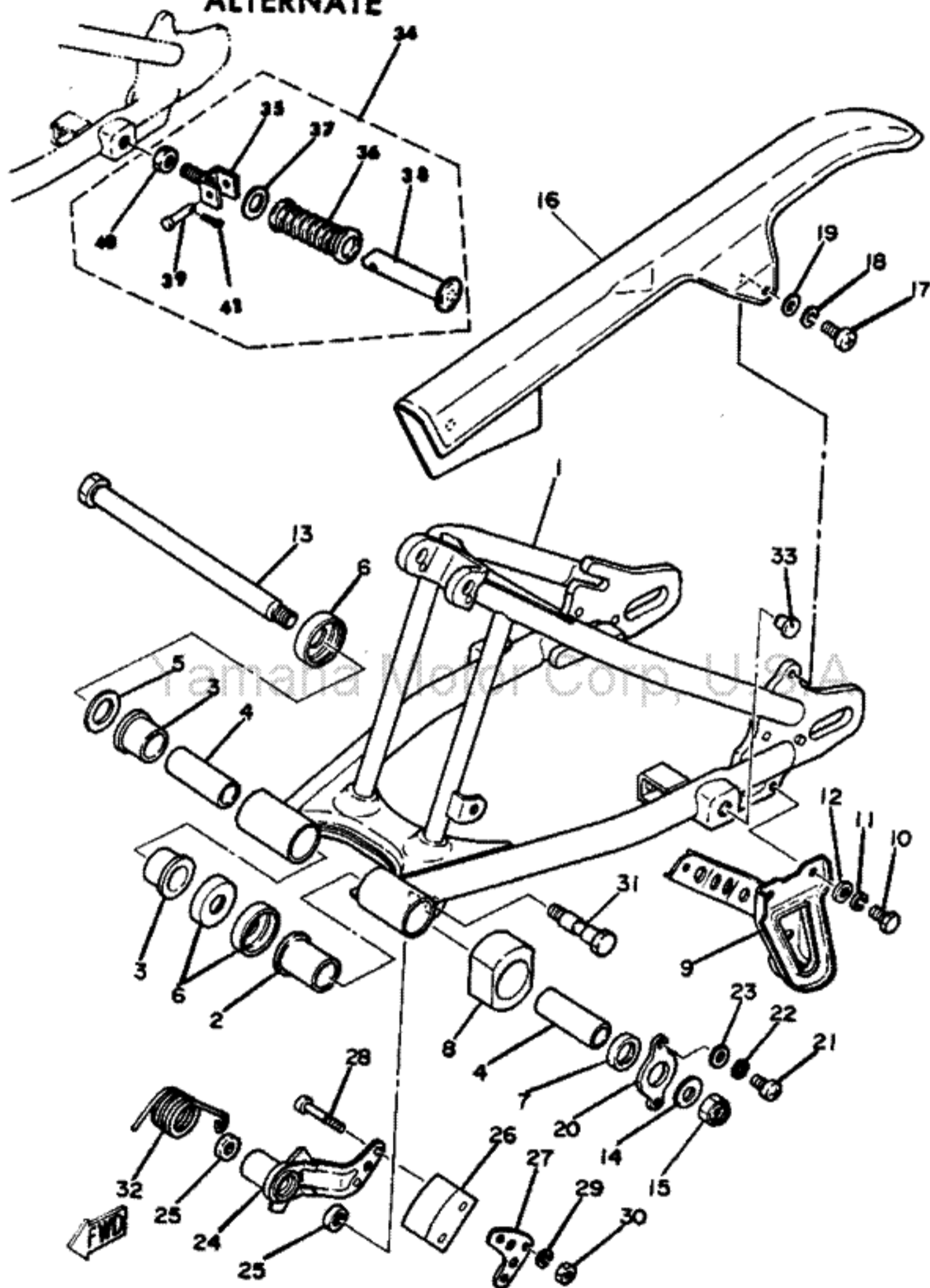

ALTERNATE

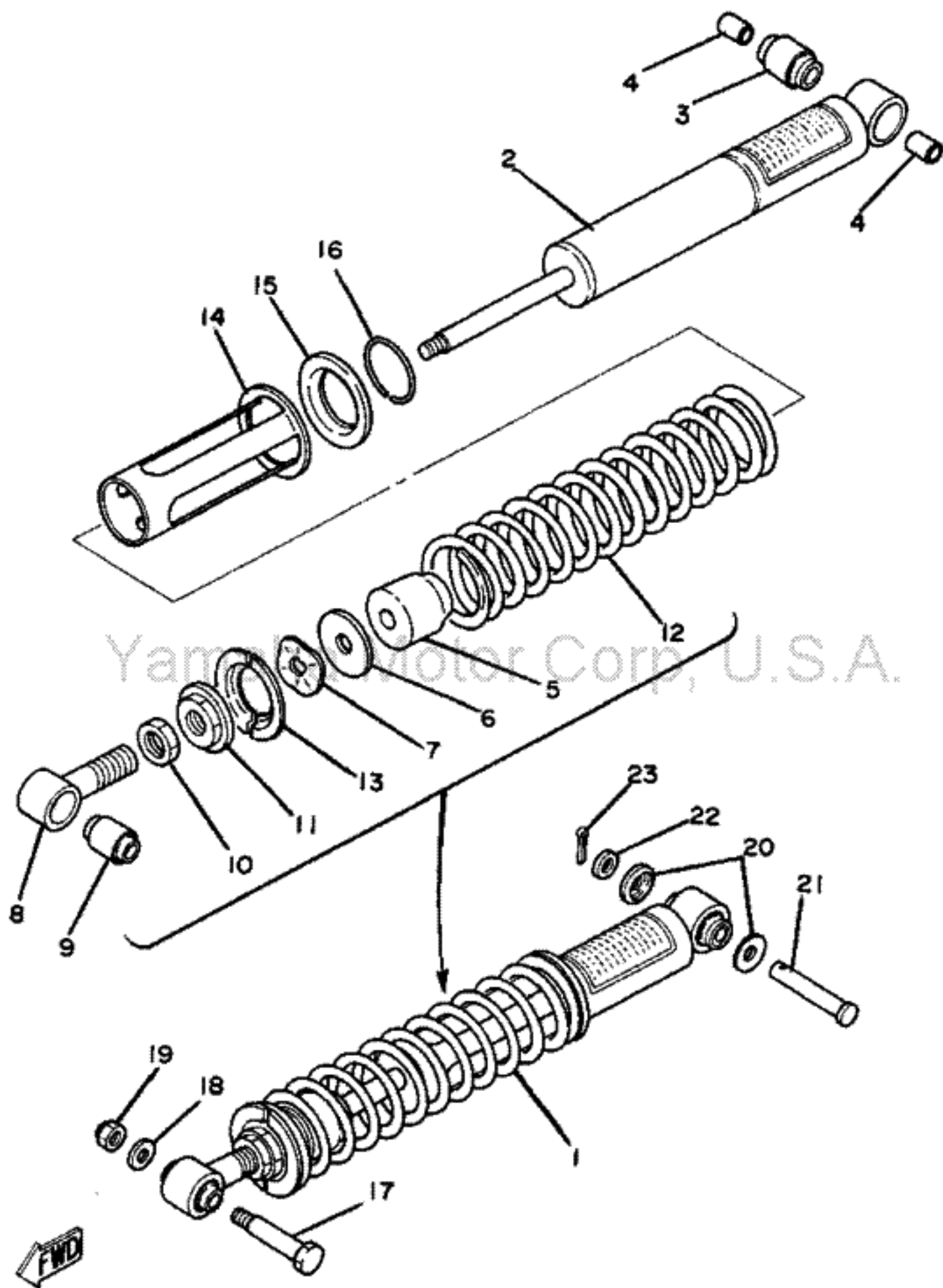









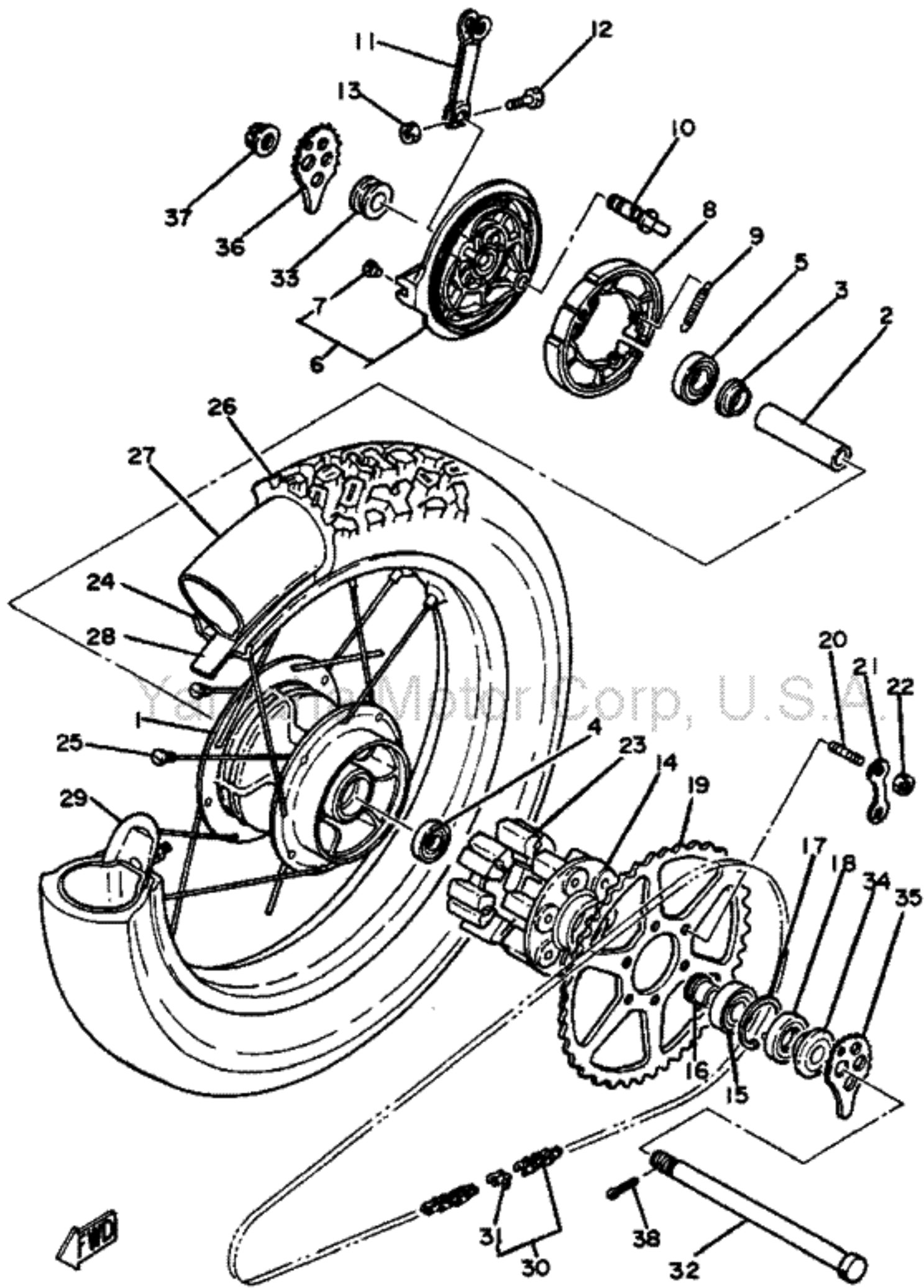



























Item	Part #	Description	Notes	Req	
1	3Y1-22110-00-33	REAR ARM COMP	YAMAHA BLACK	1	ADD TO WISH LIST 
2	3Y1-22184-00-00	BUSH		1	ADD TO WISH LIST 
3	3Y1-22123-00-00	BUSH 1		2	ADD TO WISH LIST 
4	3Y1-22124-01-00	BUSH 2 (3Y1-22124-00)		2	ADD TO WISH LIST 
5	240-22127-00-00	SHIM (156-22127-00)		1	ADD TO WISH LIST 
6	322-22128-01-00	COVER, THRUST 1		3	ADD TO WISH LIST 
7	93109-22019-00	OIL SEAL		1	ADD TO WISH LIST 
8	3Y1-22151-00-00	SEAL, GUARD		1	ADD TO WISH LIST 
9	3Y1-22318-00-00	GUARD, CHAIN		1	ADD TO WISH LIST 
10	97301-06016-00	BOLT (97301-06015)		3	ADD TO WISH LIST 
11	92903-06100-00	WASHER, SPRING (92902-06100)		3	ADD TO WISH LIST 
12	92901-06600-00	WASHER (92902-06600)		3	ADD TO WISH LIST 
13	2N6-22141-00-00	SHAFT, PIVOT		1	ADD TO WISH LIST 
14	90201-14577-00	WASHER, PLATE		1	ADD TO WISH LIST 
15	90185-14070-00	NUT, SELF-LOCKING		1	ADD TO WISH LIST 
16	3Y1-22311-00-00	CASE, CHAIN	BLACK	1	ADD TO WISH LIST 
17	92503-06015-00	SCREW, PAN HEAD (92502-06016)		2	ADD TO WISH LIST 
18	92903-06100-00	WASHER, SPRING (92902-06100)		2	ADD TO WISH LIST 
19	90201-06053-00	WASHER, PLATE		2	ADD TO WISH LIST 
20	3Y1-21329-00-00	PLATE		1	ADD TO WISH LIST 
21	92503-06012-00	SCREW, PAN HEAD (92501-06012)		2	ADD TO WISH LIST 
22	92903-06100-00	WASHER, SPRING (92902-06100)		2	ADD TO WISH LIST 
23	92901-06600-00	WASHER (92902-06600)		2	ADD TO WISH LIST 
24	3Y1-22179-00-00	ARM, TENSIONER		1	ADD TO WISH LIST 
25	93104-14044-00	OIL SEAL		2	ADD TO WISH LIST 
26	ACC-11130-00-25	TENSIONER (2N0-22178-00)		1	ADD TO WISH LIST 
27	1W1-22187-00-00	GUIDE, CHAIN		1	ADD TO WISH LIST 
28	98501-05040-00	SCREW, PAN HEAD		2	ADD TO WISH LIST 
29	92903-05100-00	WASHER, SPRING (92901-05100)		2	ADD TO WISH LIST 
30	95301-05600-00	NUT		2	ADD TO WISH LIST 
31	90109-10483-00	BOLT		1	ADD TO WISH LIST 
32	90508-35350-00	SPRING, TORSION		1	ADD TO WISH LIST 
33	90338-11111-00	PLUG		2	ADD TO WISH LIST 
34	120-27430-02-00	REAR FOOTREST ASS'Y 1	ALTERNATE PARTS	2	ADD TO WISH LIST 
35	120-27432-02-00	BRACKET 1	ALTERNATE PART	1	ADD TO WISH LIST 
36	120-27433-00-00	COVER, REAR FOOTREST	ALTERNATE PART	1	ADD TO WISH LIST 
37	90201-20279-00	WASHER, PLATE	ALTERNATE PART	1	ADD TO WISH LIST 
38	120-27431-00-00	FOOTREST, REAR 1	ALTERNATE PART	1	ADD TO WISH LIST 
39	90240-06009-00	PIN, CLEVIS	ALTERNATE PART	1	ADD TO WISH LIST 
40	95301-12700-00	NUT	ALTERNATE PART	1	ADD TO WISH LIST 
41	91401-16015-00	PIN, COTTER	ALTERNATE PART	1	ADD TO WISH LIST 











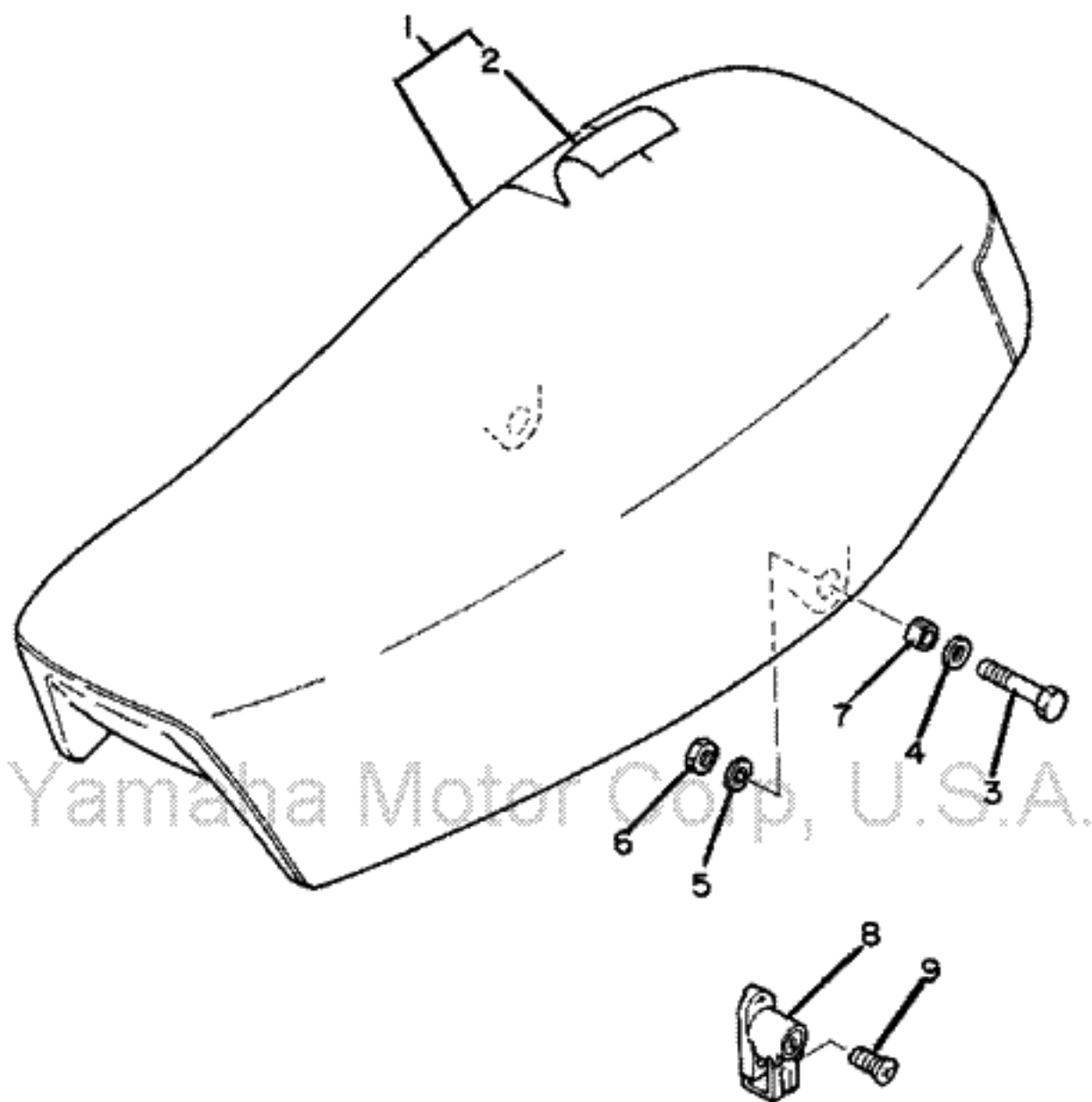

Yamaha Motor Corp, U.S.A.

Item	Part #	Description	Notes	Req	
1	3Y1-22210-00-00	SHOCK ABSORBER ASS'Y, REAR		1	ADD TO WISH LIST 
2	3Y1-22401-00-00	DAMPER SUB ASS'Y		1	ADD TO WISH LIST 
3	3R4-22226-00-00	BUSH, SHOCK ABSORBER LOWER		1	ADD TO WISH LIST 
4	90380-12051-00	BUSH, SOLID		2	ADD TO WISH LIST 
5	1W1-22493-00-00	STOPPER , BUMP		1	ADD TO WISH LIST 
6	3R4-22228-00-00	SUPPORT, BUMP STOP		1	ADD TO WISH LIST 
7	90206-14067-00	WASHER, WAVE		1	ADD TO WISH LIST 
8	3Y1-22409-00-00	UPPER BRACKET SUB ASS'Y		1	ADD TO WISH LIST 
9	1W1-22216-00-00	BUSH, REAR SHOCK ABSORBER		1	ADD TO WISH LIST 
10	90170-20211-00	NUT		1	ADD TO WISH LIST 
11	3R4-22213-00-00	SEAT, SPRING UPPER		1	ADD TO WISH LIST 
12	3Y1-22212-00-00	SPRING		1	ADD TO WISH LIST 
13	3R4-22214-00-00	GUIDE, SPRING 1		2	ADD TO WISH LIST 
14	3Y1-22224-00-00	GUIDE, SPRING 2		1	ADD TO WISH LIST 
15	3Y1-22223-00-00	SEAT, SPRING LOWER		1	ADD TO WISH LIST 
16	93440-48079-00	CIRCLIP		1	ADD TO WISH LIST 
17	90109-10554-00	BOLT		1	ADD TO WISH LIST 
18	90201-10126-00	WASHER, PLATE		1	ADD TO WISH LIST 
19	95602-10100-00	NUT, U		1	ADD TO WISH LIST 
20	1W1-22128-00-00	COVER, THRUST 1		2	ADD TO WISH LIST 
21	90240-12075-00	PIN, CLEVIS		1	ADD TO WISH LIST 
22	92901-12600-00	WASHER, PLATE		1	ADD TO WISH LIST 
23	91401-30022-00	PIN, COTTER		1	ADD TO WISH LIST 



Item	Part #	Description	Notes	Req	
1	3Y1-25311-00-98	HUB, REAR	LOW GLOSS BLK	1	ADD TO WISH LIST 
2	275-25317-00-00	SPACER, BEARING		1	ADD TO WISH LIST 
3	146-25315-00-00	FLANGE, SPACER		1	ADD TO WISH LIST 
4	93306-20309-00	BEARING (B6203)		1	ADD TO WISH LIST 
5	93306-20310-00	BEARING (B6203RS)		1	ADD TO WISH LIST 
6	3Y1-25026-00-98	BRAKE SHOE PLATE ASS'Y	LOW GLOSS BLK	1	ADD TO WISH LIST 
7	90480-10068-00	GROMMET		1	ADD TO WISH LIST 
8	3Y1-25330-00-00	BRAKE SHOE COMP		2	ADD TO WISH LIST 
9	90506-16036-00	SPRING, TENSION		2	ADD TO WISH LIST 
10	538-25351-01-00	CAMSHAFT		1	ADD TO WISH LIST 
11	1E2-25155-00-00	LEVER, CAMSHAFT 1		1	ADD TO WISH LIST 
12	90101-06278-00	BOLT		1	ADD TO WISH LIST 
13	95301-06600-00	NUT		1	ADD TO WISH LIST 
14	3Y1-25366-00-98	CLUTCH, HUB	LOW GLOSS BLK	1	ADD TO WISH LIST 
15	93306-20421-00	BEARING (B6204)		1	ADD TO WISH LIST 
16	3Y1-25377-00-00	COLLAR, WHEEL		1	ADD TO WISH LIST 
17	93420-47010-00	CIRCLIP		1	ADD TO WISH LIST 
18	93102-28022-00	OIL SEAL		1	ADD TO WISH LIST 
19	3Y1-25447-10-33	SPROCKET, DRIVEN (47T)		1	ADD TO WISH LIST 
20	90116-08218-00	BOLT, STUD		6	ADD TO WISH LIST 
21	90215-08160-00	WASHER, LOCK		3	ADD TO WISH LIST 
22	90170-08258-00	NUT		6	ADD TO WISH LIST 
23	3Y1-25364-00-00	DAMPER		6	ADD TO WISH LIST 
24	94421-17242-00	RIM (2.15-17)		1	ADD TO WISH LIST 
25	3Y1-25304-00-00	SPOKE SET, REAR		1	ADD TO WISH LIST 
26	94146-17415-00	TIRE (4.60-17)		1	ADD TO WISH LIST 
27	94246-17158-00	TUBE (4.60-17)		1	ADD TO WISH LIST 
28	94332-17107-00	BAND, RIM (3.25-17)		1	ADD TO WISH LIST 
29	3Y1-25394-00-00	SPACER, BEAD		1	ADD TO WISH LIST 
30	94585-20099-00	CHAIN (52 ODS-98L)		1	ADD TO WISH LIST 
31	94685-20011-00	JOINT, CHAIN		1	ADD TO WISH LIST 
32	150-25381-00-00	AXLE, WHEEL		1	ADD TO WISH LIST 
33	90387-17141-00	COLLAR		1	ADD TO WISH LIST 
34	3Y1-25383-00-00	COLLAR, WHEEL		1	ADD TO WISH LIST 
35	3Y1-25388-00-00	PULLER, CHAIN 1		1	ADD TO WISH LIST 
36	3Y1-25389-00-00	PULLER, CHAIN 2		1	ADD TO WISH LIST 
37	90171-16024-00	NUT, CASTLE		1	ADD TO WISH LIST 
38	91401-30030-00	PIN, COTTER		1	ADD TO WISH LIST 



Item	Part #	Description	Notes	Req	
1	3Y1-W2473-00-00	SEMI-DOUBLE SEAT ASSY		1	ADD TO WISH LIST 
2	3Y1-24731-00-00	COVER, DOUBLE SEAT		1	ADD TO WISH LIST 
3	97301-06045-00	BOLT		2	ADD TO WISH LIST 
4	90201-06053-00	WASHER, PLATE		2	ADD TO WISH LIST 
5	92903-06100-00	WASHER, SPRING (92901-06100)		2	ADD TO WISH LIST 
6	95301-06600-00	NUT		2	ADD TO WISH LIST 
7	90387-10661-00	COLLAR		2	ADD TO WISH LIST 
8	2A6-21308-00-00	HELMET HANGER ASSY		1	ADD TO WISH LIST 
9	92603-06018-00	SCREW, FLAT HEAD (92701-06018)		1	ADD TO WISH LIST 

SERVICE DATA

FILE MOTORCYCLE — 250 SECTION

DATE 10/3/80 BUL M80-052

FILE MOTORCYCLE — 250 SECTION

DATE 10/3/80 BUL M80-052

XT250H 1981 SERVICE DATA

MODEL — IBM I.D. NUMBER	XT250H-R	XT250H-S	3Y1
Initial Engine Number / Frame Number	3Y1-100101 / 3Y1-100101		
Basic Color(s)	Brilliant Red (R) Crystal Silver (S)		
Fuel Type / Fuel Tank Capacity / Reserve Capacity	Regular / 8 Lit. (2.1 Gal.) / 1.7 Lt. (0.5 Gal.)		
Dry Vehicle Weight	113 kg (249 lbs.)		
ENGINE TYPE	4-Stroke, SOHC, Air-Cooled, Single		
Bore/Stroke/Number Cylinders/Displacement (cc)	75mm / 56.5mm / 1 / 249cc		
Compression Ratio/Compression Pressure Min ~ Max	9.2:1 / 10.0 ~ 13.0 kg/cm ²		
Piston Skirt Clearance New / Max	0.035 ~ 0.055mm / 0.1mm		
Ring End Gap Top / 2nd / 3rd	0.2 ~ 0.4mm / 0.2 ~ 0.4mm / 0.3 ~ 0.9mm		
Valve Clearance (Cold) Intake / Exhaust	0.08mm / 0.15mm		
Oil Pressure Hot / rpm	NA		
Oiling System	Wet Sump		
Capacity: Dry	1600cc		
Oil and Filter Change	1300cc		
Oil Change	1300cc		
Lubricant: Temp. Above 5°C (40°F)	Yamalube 4* or SAE 20W40 SE		
Temp. Below 15°C (60°F)	Yamalube 4* or SAE 20W40 SE		
AUTOLUBE — Min Stroke / Color Code	∅		
Minimum Output @ 200 Cycles	∅		
Maximum Output @ 200 Cycles	∅		
CARBURETOR — Mfr. / Type / I.D. Number	Mikuni / VM28SS / 3Y1		
Main Jet / Pilot Jet	165 / 17.5		
Needle Jet / Jet Needle-Clip Position	0-8 / 5DM65 Fixed		
Slide Cutaway or Throttle Valve	2.5 (30)		
Float Level / Fuel Level	23.5 ± 0.5mm / 3 ~ 5mm		
Idle rpm	1200 rpm		
Max CO* / Max HC* / Set CO	7.0 % / 300 ppm / 2.0 % (All settings @ Idle)		
SUSPENSION			
Front Forks: Oil Type / Level / Qty	10 Wt. Fork Oil* / 465mm / 269 ± 2cc		
Gas Pressure	∅		
Spring Length Std.	456.5mm		
Monoshock: Oil Type / Qty	NA		
Gas Pressure	15 kg/cm ² (213 psi)		
Minimum Brake Lining Thickness	Front: 2mm Rear: 2mm		
Tire Size (Nominal Pressure)	F: 3.00-21 (1.3 kg/cm ² / 18 psi) R: 4.80-17 (1.5 kg/cm ² / 21 psi)		
TRANSMISSION — Oil Type/Qty Chg/Qty Reasonable	See ENGINE Above		
Primary Drive Type / Teeth / Ratio	Spur Gear / 72-23 / 3.130		
Secondary Drive Type / Teeth / Chain	Chain Drive / 47-15 / 520DS-100L		
Clutch Friction Plate Thickness Std ~ Min	2.8 ~ 2.5mm		
Clutch Spring Length Std ~ Min	34.6 ~ 33.6mm		
Middle Gear Case Capacity	∅		
Final Gear Case Capacity	∅		
Gear Case Lubricant: Temp. Above 5°C (40°F)	∅		
Temp. Below 15°C (60°F)	∅		
All Weather Conditions	∅		









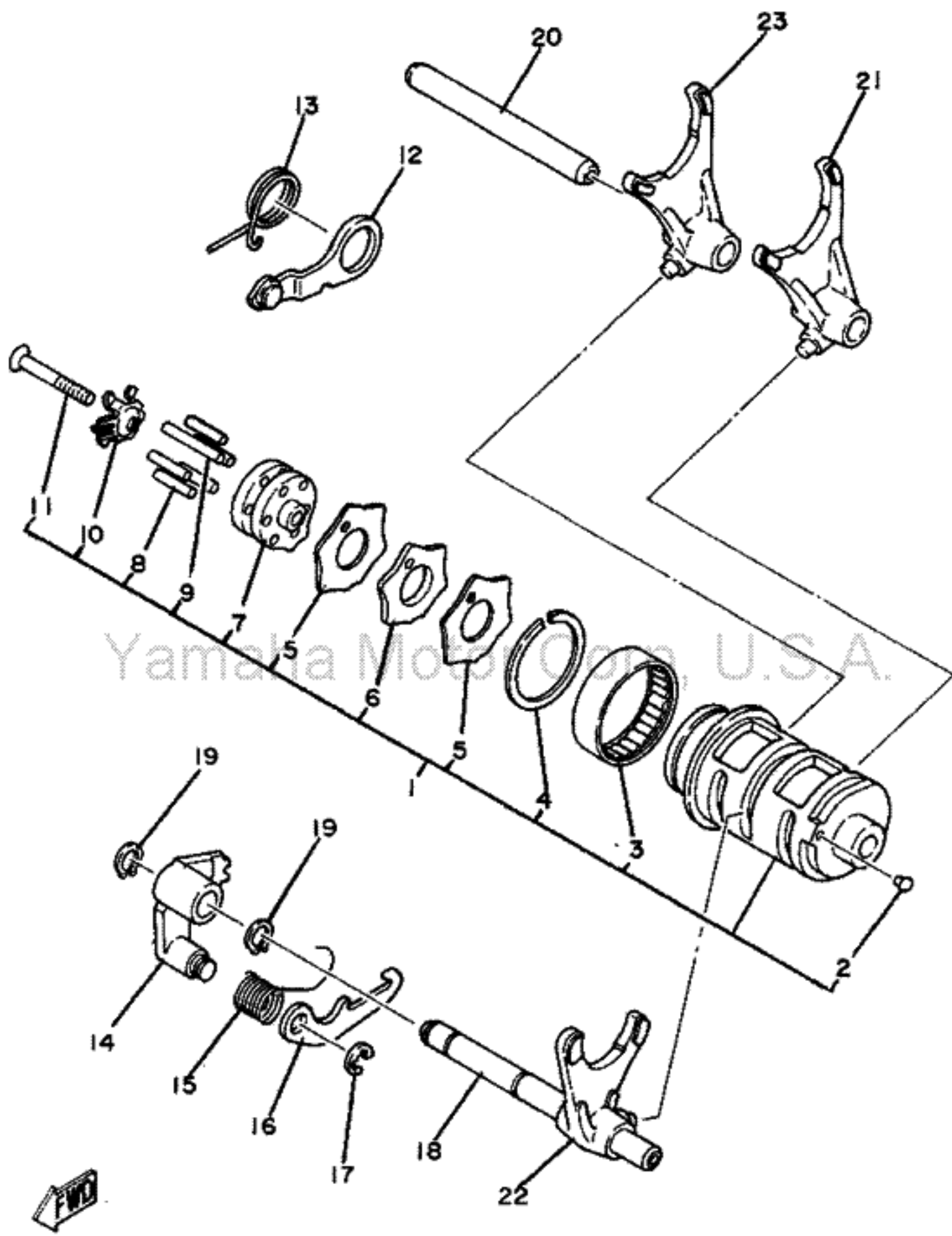





CHARGING SYSTEM	Flywheel Magneto / Single Phase / Half Wave
Battery: Model / Specific Gravity / Charge Rate	Nippon Denchi 6N6-3B-1 (6V 6AH) / 1.26 / 0.6A
Maximum Output	7.6V 2.0A @ 8000 rpm
TROUBLESHOOTING	
Field Coil Color Code / Ω	∅
Charge Coil Color Code / Ω	Grn ~ Blk / 0.34 Ω ± 10%
IGNITION SYSTEM	Capacitor-Discharge Ignition
Ignition Timing	7° Mark
	Std: 7° BTDC @ 1200 rpm Adv: 32 ± 3° @ 4000 rpm
Spark Plug Type	NGK BP-7ES or Nippon Denso W22EP
Spark Plug Gap / Torque / Cap Ω	0.7 ~ 0.8mm / 2.0 m·kg / 10K Ω ± 20%
Point Gap / Condenser Capacitance	∅ / ∅
TROUBLESHOOTING	
Ignition Coil Test Gap / Primary Ω / Secondary Ω	6mm / 1.0 Ω ± 15% / 5.9K Ω ± 15%
Pulser Coil or Pickup Coil Color Code / Ω	Gry-Red ~ Wht-Grn / 215 Ω ± 10%
Source Coil Color Code / Ω	Brn ~ Red / 490 Ω ± 10%
LIGHTING SYSTEM	
Headlight / Taillight / Signal Rating	6V35-35W / 6V25-5.3W / 6V17W
TROUBLESHOOTING	
Lighting Coil Color Code / Ω	Yel ~ Blk / 0.21 Ω ± 10%
TORQUE VALUES	
Front Axle Nut	14 x 1.5: 8.3 ~ 13.0 m·kg
Front Axle Holder Nut	∅
Rear Axle Nut	16 x 1.5: 8.3 ~ 13.0 m·kg
Rear Axle Pinch Bolt	∅
Clutch Nut	20 x 1.0: 7.0 m·kg
Drain Plug	40 x 1.5: 3.2 m·kg
Cylinder Head Cover	6 x 1.0: 1.0 m·kg
Cylinder Head:	10 x 1.25: 3.8 m·kg
	8 x 1.25: 2.0 m·kg
Engine Mounting Bolts: Front Lower	8 x 1.25: 3.2 m·kg
	Rear Lower
	8 x 1.25: 3.2 m·kg
	Rear Lower
	8 x 1.25: 2.0 m·kg
	Upper
	8 x 1.25: 3.2 m·kg

 ∅ = Does Not Apply To This Model
 NA = Information Not Available

*Available From Yamaha Parts Distributors Inc.

Item	Part #	Description	Notes	Req
No Parts List for Image				ADD TO WISH LIST 





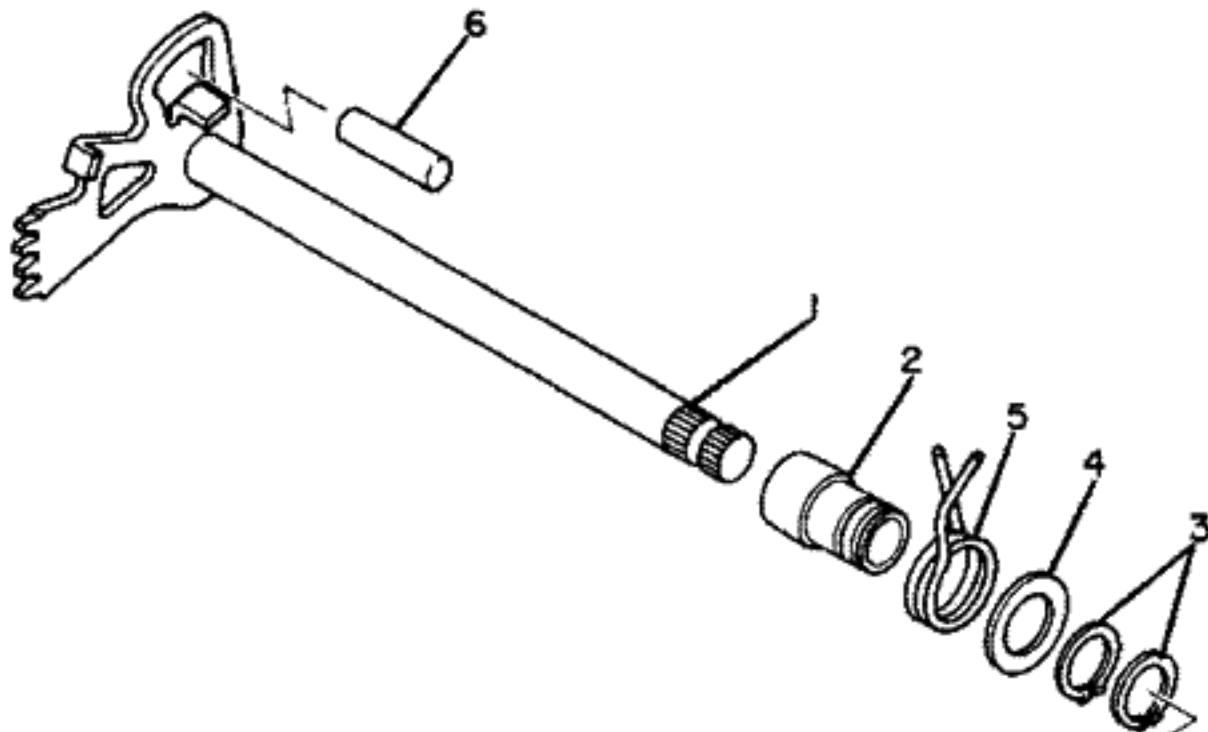



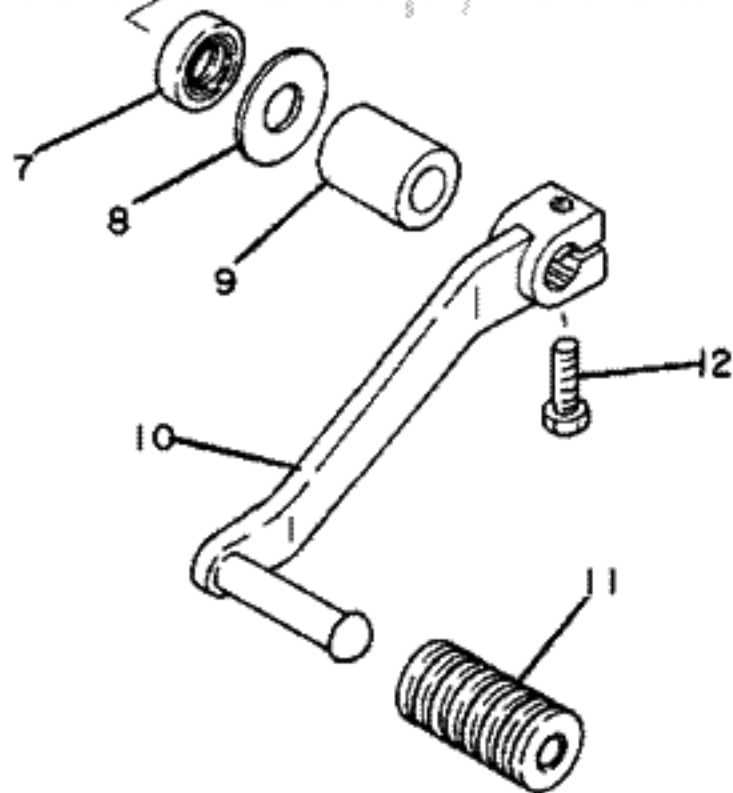





Item	Part #	Description	Notes	Req	
1	3Y1-18540-00-00	SHIFT CAM ASS'Y		1	ADD TO WISH LIST 
2	136-18542-00-00	POINT, NEUTRAL		1	ADD TO WISH LIST 
3	93315-23612-00	BEARING, CYLINDRICAL		1	ADD TO WISH LIST 
4	93440-34025-00	CIRCLIP		1	ADD TO WISH LIST 
5	3Y1-18161-00-00	GUIDE, PLATE STOPPER		2	ADD TO WISH LIST 
6	3Y1-18141-00-00	PLATE, STOPPER		1	ADD TO WISH LIST 
7	3Y1-18185-01-00	SEGMENT		1	ADD TO WISH LIST 
8	93604-18100-00	PIN, DOWEL		5	ADD TO WISH LIST 
9	93604-29151-00	PIN, DOWEL		1	ADD TO WISH LIST 
10	2K9-18561-00-00	PLATE, SIDE 1		1	ADD TO WISH LIST 
11	98701-05035-00	SCREW, FLAT HEAD		1	ADD TO WISH LIST 
12	3Y1-18140-00-00	STOPPER LEVER ASS'Y		1	ADD TO WISH LIST 
13	90508-26434-00	SPRING, TORSION		1	ADD TO WISH LIST 
14	3Y1-18122-00-00	LEVER, SHIFT 2		1	ADD TO WISH LIST 
15	90508-12430-00	SPRING, TORSION		1	ADD TO WISH LIST 
16	2K7-18151-00-00	LEVER, SHIFT 3		1	ADD TO WISH LIST 
17	93430-07012-00	CIRCLIP		1	ADD TO WISH LIST 
18	3Y1-18531-00-00	BAR, SHIFT FORK GUIDE 1		1	ADD TO WISH LIST 
19	93410-10025-00	CIRCLIP		2	ADD TO WISH LIST 
20	3Y1-18535-00-00	BAR, SHIFT FORK GUIDE 2		1	ADD TO WISH LIST 
21	3Y1-18511-00-00	FORK, SHIFT 1		1	ADD TO WISH LIST 
22	3Y1-18512-00-00	FORK, SHIFT 2		1	ADD TO WISH LIST 
23	3Y1-18513-00-00	FORK, SHIFT 3		1	ADD TO WISH LIST 



Yamaha Motor Corp, U.S.A.





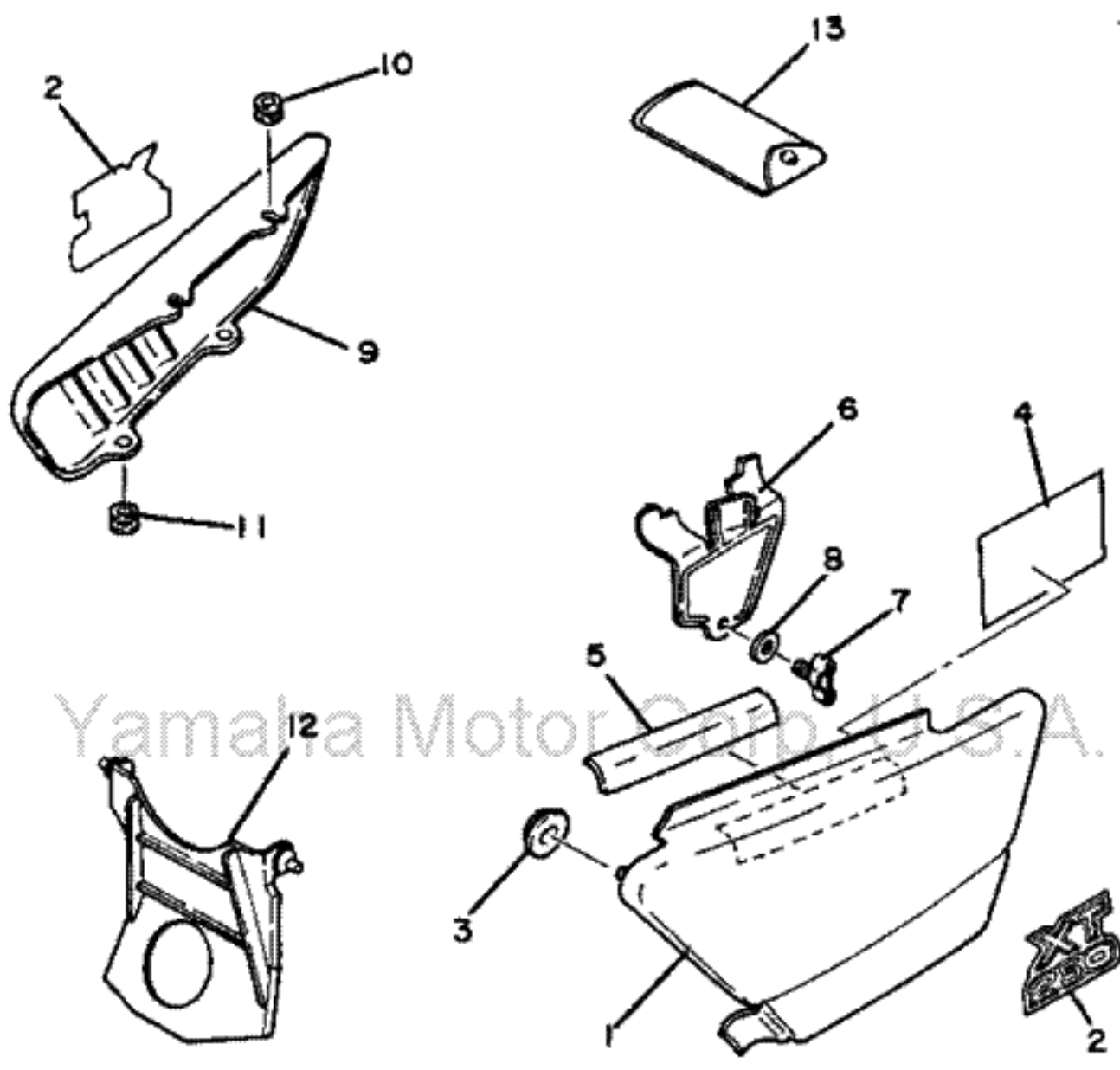











Item	Part #	Description	Notes	Req	
1	3Y1-18101-00-00	SHIFT SHAFT ASSY		1	ADD TO WISH LIST 
2	90387-12787-00	COLLAR		1	ADD TO WISH LIST 
3	93410-17008-00	CIRCLIP		2	ADD TO WISH LIST 
4	90201-17255-00	WASHER, PLATE		1	ADD TO WISH LIST 
5	90508-32374-00	SPRING, TORSION		1	ADD TO WISH LIST 
6	93608-30152-00	PIN, DOWEL		1	ADD TO WISH LIST 
7	93102-12106-00	OIL SEAL		1	ADD TO WISH LIST 
8	90201-12588-00	WASHER, PLATE		1	ADD TO WISH LIST 
9	90560-12191-00	SPACER		1	ADD TO WISH LIST 
10	3Y1-18111-00-00	PEDAL, SHIFT		1	ADD TO WISH LIST 
11	132-18113-01-00	COVER, SHIFT PEDAL		1	ADD TO WISH LIST 
12	97321-06020-00	BOLT		1	ADD TO WISH LIST 









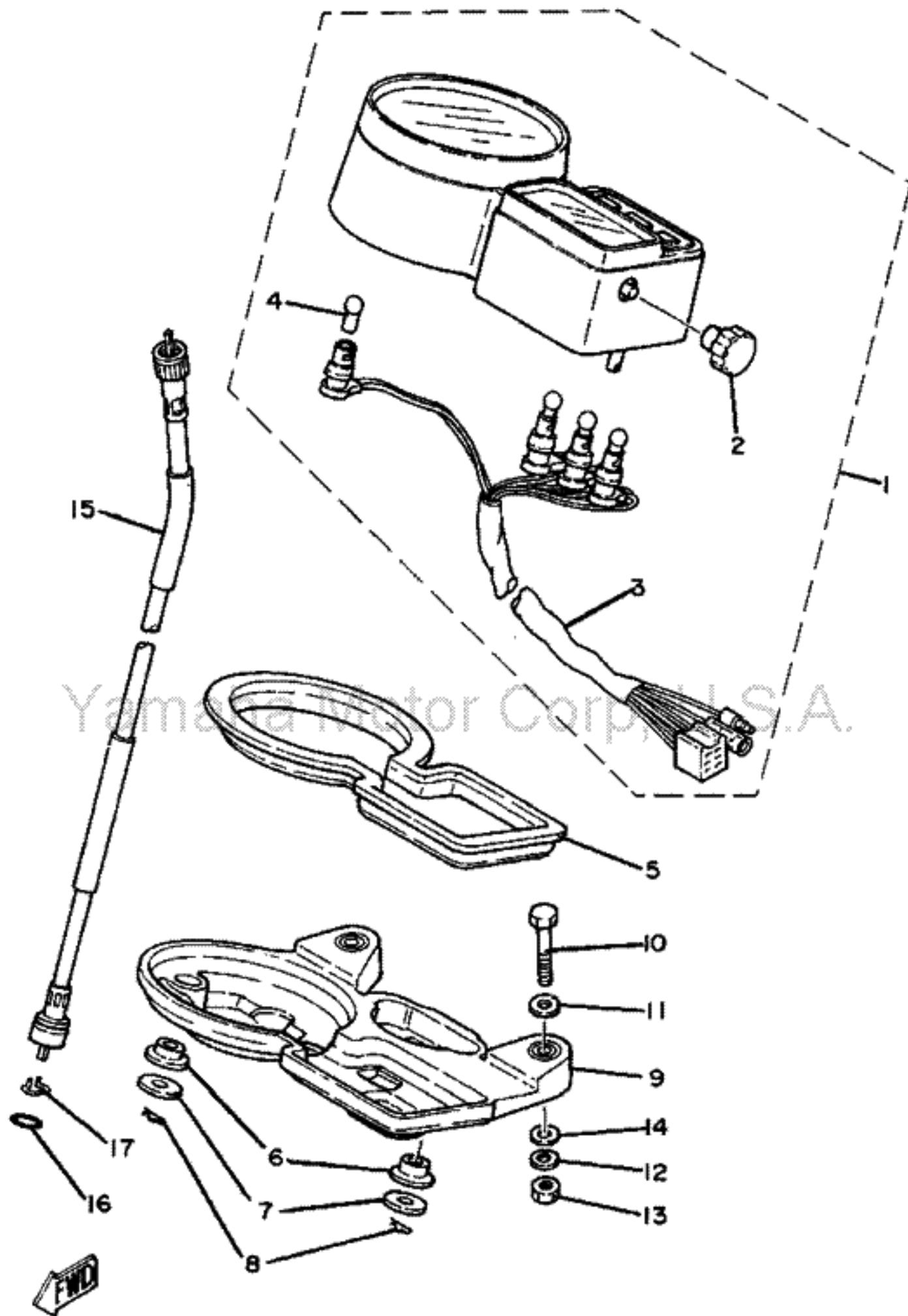









Yamaha Motor Corp. U.S.A.



Item	Part #	Description	Notes	Req	
1	3Y1-21711-00-20	COVER, SIDE (L. H.)	U.R. CRYSTAL SILVER	1	ADD TO WISH LIST 
1	3Y1-21711-00-63	COVER, SIDE (L.H.)	U.R. BRILLIANT RED	1	ADD TO WISH LIST 
2	3Y1-21786-10-00	EMBLEM 6		2	ADD TO WISH LIST 
3	90480-01141-00	GROMMET		2	ADD TO WISH LIST 
4	3Y1-21683-10-00	PLATE, SPECIFICATION		1	ADD TO WISH LIST 
5	3Y1-21746-00-00	DAMPER		1	ADD TO WISH LIST 
6	3Y1-28185-00-00	LID		1	ADD TO WISH LIST 
7	90122-05010-00	BOLT, WING		1	ADD TO WISH LIST 
8	90201-05031-00	WASHER, PLATE		1	ADD TO WISH LIST 
9	3Y1-21721-00-20	COVER, SIDE (R.H.)	U.R. CRYSTAL SILVER	1	ADD TO WISH LIST 
9	3Y1-21721-00-63	COVER, SIDE (R.H.)	U.R. BRILLIANT RED	1	ADD TO WISH LIST 
10	90480-08264-00	GROMMET		2	ADD TO WISH LIST 
11	90480-08264-00	GROMMET		2	ADD TO WISH LIST 
12	3Y1-2177F-00-00	COVER		1	ADD TO WISH LIST 
13	3Y1-28100-10-00	TOOL KIT		1	ADD TO WISH LIST 





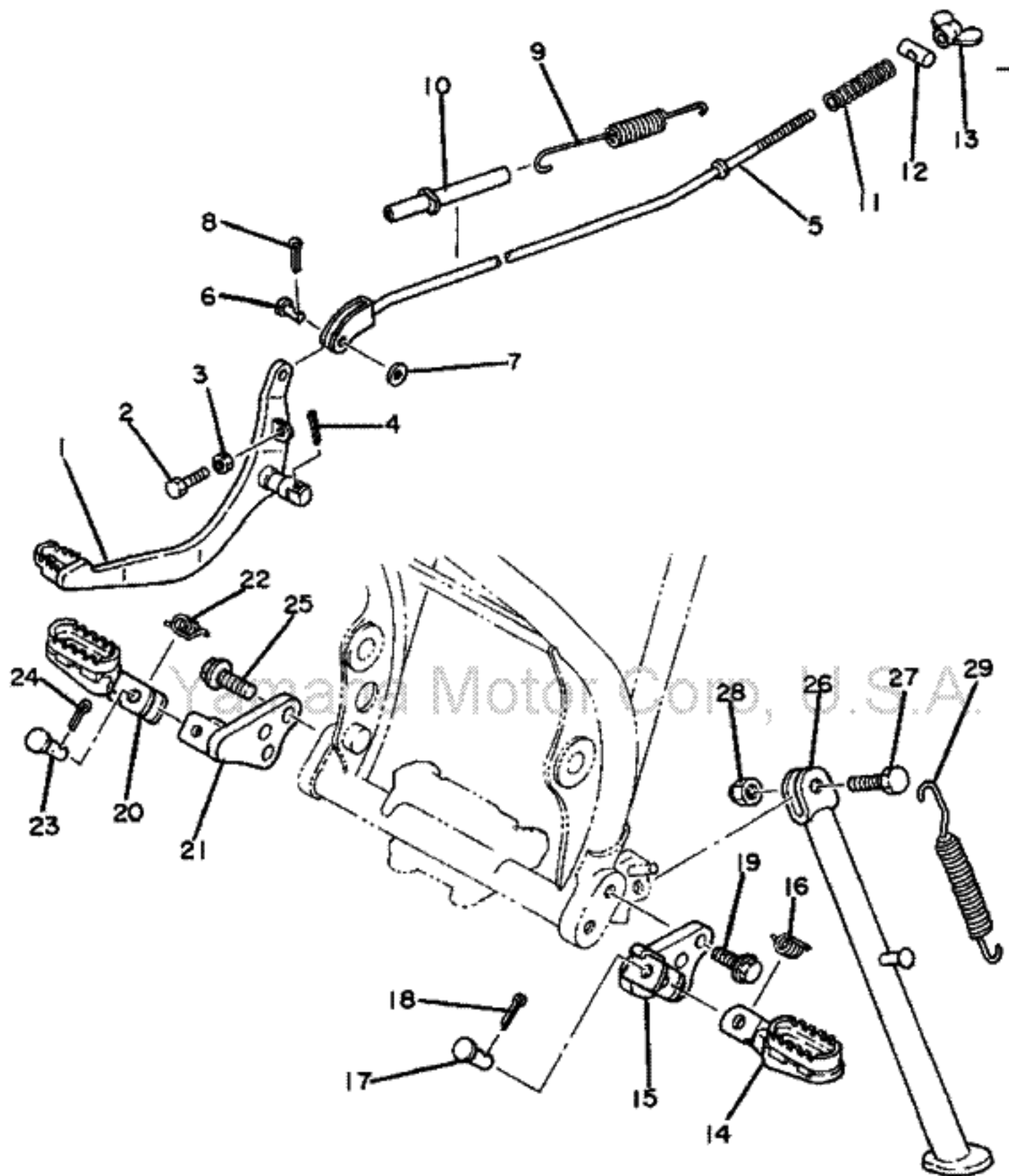



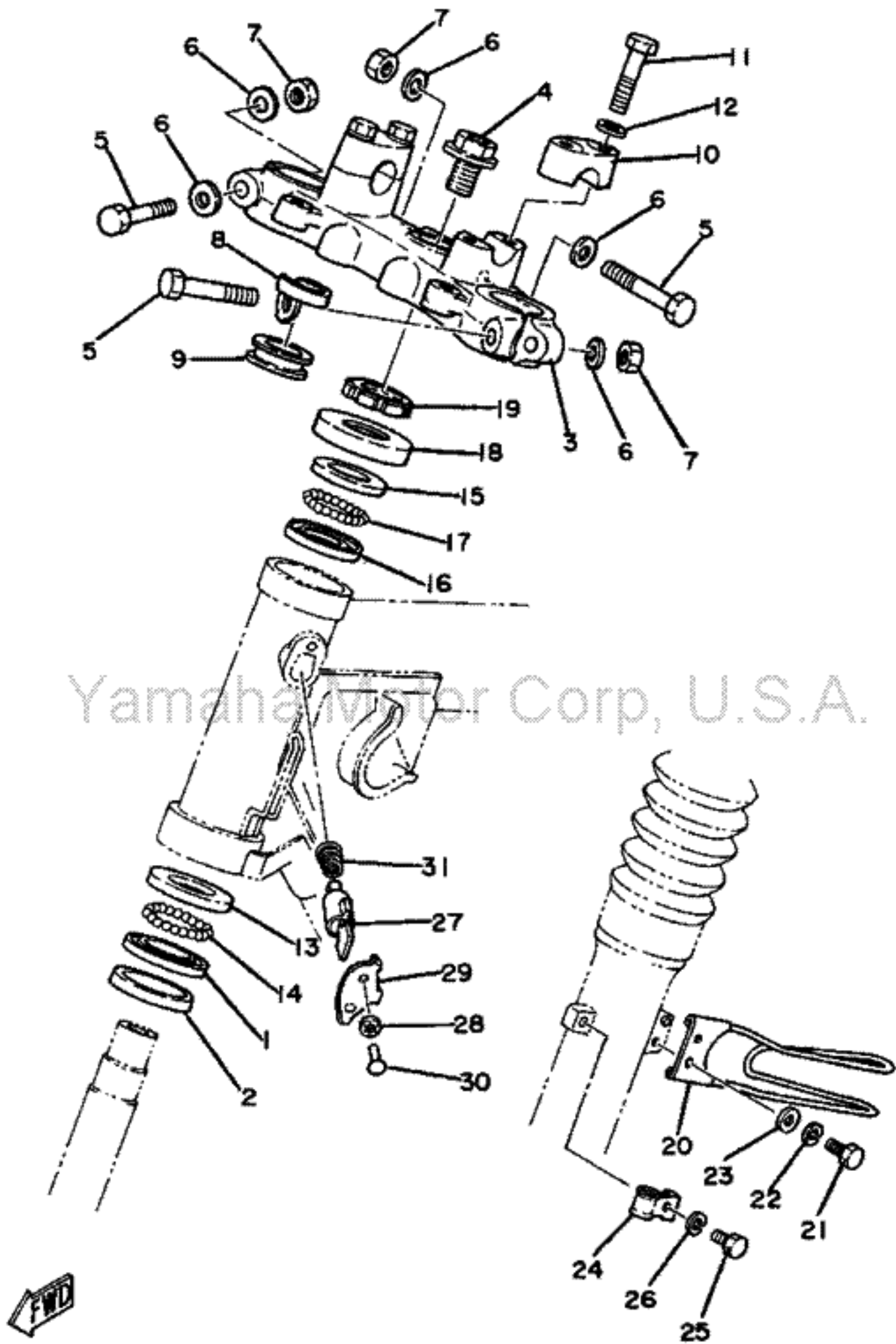























Item	Part #	Description	Notes	Req	
1	3Y1-83570-A0-00	SPEEDOMETER ASS'Y		1	ADD TO WISH LIST 
2	3Y1-83578-00-00	KNOB, TRIP METER		1	ADD TO WISH LIST 
3	3Y1-83509-00-00	SOCKET CORD ASS'Y		1	ADD TO WISH LIST 
4	122-83516-11-00	BULB (6V-3W) (122-83516-11)		4	ADD TO WISH LIST 
5	3Y1-83513-00-00	DAMPER		1	ADD TO WISH LIST 
6	1M1-83526-00-00	DAMPER 2		3	ADD TO WISH LIST 
7	90201-05033-00	WASHER, PLATE		3	ADD TO WISH LIST 
8	90468-12007-00	CLIP		3	ADD TO WISH LIST 
9	3Y1-83519-00-00	BRACKET, METER		1	ADD TO WISH LIST 
10	97301-06045-00	BOLT		2	ADD TO WISH LIST 
11	92901-06600-00	WASHER, PLATE		2	ADD TO WISH LIST 
12	92903-06100-00	WASHER, SPRING (92902-06100)		2	ADD TO WISH LIST 
13	95302-06600-00	NUT		2	ADD TO WISH LIST 
14	92903-06200-00	WASHER (92902-06200)		2	ADD TO WISH LIST 
15	3Y1-83550-00-00	SPEEDOMETER CABLE ASS'Y		1	ADD TO WISH LIST 
16	93210-14104-00	O-RING		1	ADD TO WISH LIST 
17	102-25137-00-00	RING, STOP		1	ADD TO WISH LIST 



Item	Part #	Description	Notes	Req	
1	3Y1-27211-00-90	PEDAL, BRAKE	UNI CHROME (BLK)	1	ADD TO WISH LIST 
2	90101-06478-00	BOLT		1	ADD TO WISH LIST 
3	95301-06700-00	NUT		1	ADD TO WISH LIST 
4	91401-30020-00	PIN, COTTER		1	ADD TO WISH LIST 
5	3Y1-27231-00-00	ROD, BRAKE		1	ADD TO WISH LIST 
6	90240-06040-00	PIN, CLEVIS		1	ADD TO WISH LIST 
7	92903-06200-00	WASHER, PLAIN (92901-06200)		1	ADD TO WISH LIST 
8	91401-20012-00	PIN, COTTER		1	ADD TO WISH LIST 
9	90506-18154-00	SPRING, TENSION		1	ADD TO WISH LIST 
10	1M1-27244-00-00	COVER		1	ADD TO WISH LIST 
11	90501-10245-00	SPRING, COMPRESSION		1	ADD TO WISH LIST 
12	90249-12008-00	PIN		1	ADD TO WISH LIST 
13	90175-06013-00	NUT, WING		1	ADD TO WISH LIST 
14	3Y1-27411-00-R4	FOOTREST 1	BLACK	1	ADD TO WISH LIST 
15	3Y1-27412-00-R4	BRACKET, FOOTREST 1	BLACK	1	ADD TO WISH LIST 
16	90508-20023-00	SPRING, TORSION		1	ADD TO WISH LIST 
17	91701-08038-00	PIN, CLEVIS		1	ADD TO WISH LIST 
18	91401-25015-00	PIN, COTTER (91401-25012)		1	ADD TO WISH LIST 
19	95821-10025-00	BOLT, FLANGE		2	ADD TO WISH LIST 
20	3Y1-27421-00-R4	FOOTREST 2	BLACK	1	ADD TO WISH LIST 
21	3Y1-27422-00-R4	BRACKET, FOOTREST 2	BLACK	1	ADD TO WISH LIST 
22	90508-20023-00	SPRING, TORSION		1	ADD TO WISH LIST 
23	91701-08038-00	PIN, CLEVIS		1	ADD TO WISH LIST 
24	91401-25015-00	PIN, COTTER (91401-25012)		1	ADD TO WISH LIST 
25	95821-10025-00	BOLT, FLANGE		2	ADD TO WISH LIST 
26	3Y1-27311-00-33	STAND, SIDE	YAMAHA BLACK	1	ADD TO WISH LIST 
27	90109-08032-00	BOLT		1	ADD TO WISH LIST 
28	90185-08055-00	NUT, SELF-LOCKING		1	ADD TO WISH LIST 
29	90507-29009-00	SPRING, TENSION		1	ADD TO WISH LIST 



Yamaha Motor Corp, U.S.A.

Item	Part #	Description	Notes	Req	
1	156-23411-00-00	RACE, BALL 1		1	ADD TO WISH LIST 
2	164-23462-00-00	SEAL, STEERING		1	ADD TO WISH LIST 
3	3Y1-23435-00-98	CROWN, HANDLE	LOW GLOSS BLK	1	ADD TO WISH LIST 
4	90105-14102-00	BOLT, WASHER BASED		1	ADD TO WISH LIST 
5	97313-08055-00	BOLT		3	ADD TO WISH LIST 
6	92901-08600-00	WASHER, PLATE		5	ADD TO WISH LIST 
7	95303-08600-00	NUT		3	ADD TO WISH LIST 
8	3Y1-23317-A0-00	HOLDER, CABLE		1	ADD TO WISH LIST 
9	1W1-23389-00-00	GUIDE, CABLE		1	ADD TO WISH LIST 
10	1E6-23441-10-98	HOLDER, HANDLE UPPER (1E6-23441-00-98)	LOW GLOSS BLK	2	ADD TO WISH LIST 
11	90106-08032-00	BOLT		4	ADD TO WISH LIST 
12	92901-08600-00	WASHER, PLATE		4	ADD TO WISH LIST 
13	156-23412-00-00	RACE, BALL 2		1	ADD TO WISH LIST 
14	93501-04011-00	BALL		19	ADD TO WISH LIST 
15	122-23411-00-00	RACE, BALL 1		1	ADD TO WISH LIST 
16	122-23412-00-00	RACE, BALL 2		1	ADD TO WISH LIST 
17	93503-16010-00	BALL		22	ADD TO WISH LIST 
18	583-23416-01-00	COVER, BALL RACE 2		1	ADD TO WISH LIST 
19	90179-25033-00	NUT		1	ADD TO WISH LIST 
20	2N6-23318-00-00	HOLDER, CABLE 1		1	ADD TO WISH LIST 
21	97301-06016-00	BOLT		1	ADD TO WISH LIST 
22	92903-06100-00	WASHER, SPRING (92901-06100)		1	ADD TO WISH LIST 
23	92901-06600-00	WASHER, PLATE		1	ADD TO WISH LIST 
24	3Y1-23319-00-00	HOLDER, CABLE 2		1	ADD TO WISH LIST 
25	97306-06012-00	BOLT		1	ADD TO WISH LIST 
26	92906-06100-00	WASHER, SPRING		1	ADD TO WISH LIST 
27	2A6-23408-00-00	STEERING LOCK ASSY		1	ADD TO WISH LIST 
28	90208-04029-00	WASHER, CONICAL SPRING		1	ADD TO WISH LIST 
29	584-23484-01-00	CAP, HANDLE LOCK		1	ADD TO WISH LIST 
30	90269-04003-00	RIVET		1	ADD TO WISH LIST 
31	90502-09024-00	SPRING, CONICAL		1	ADD TO WISH LIST 

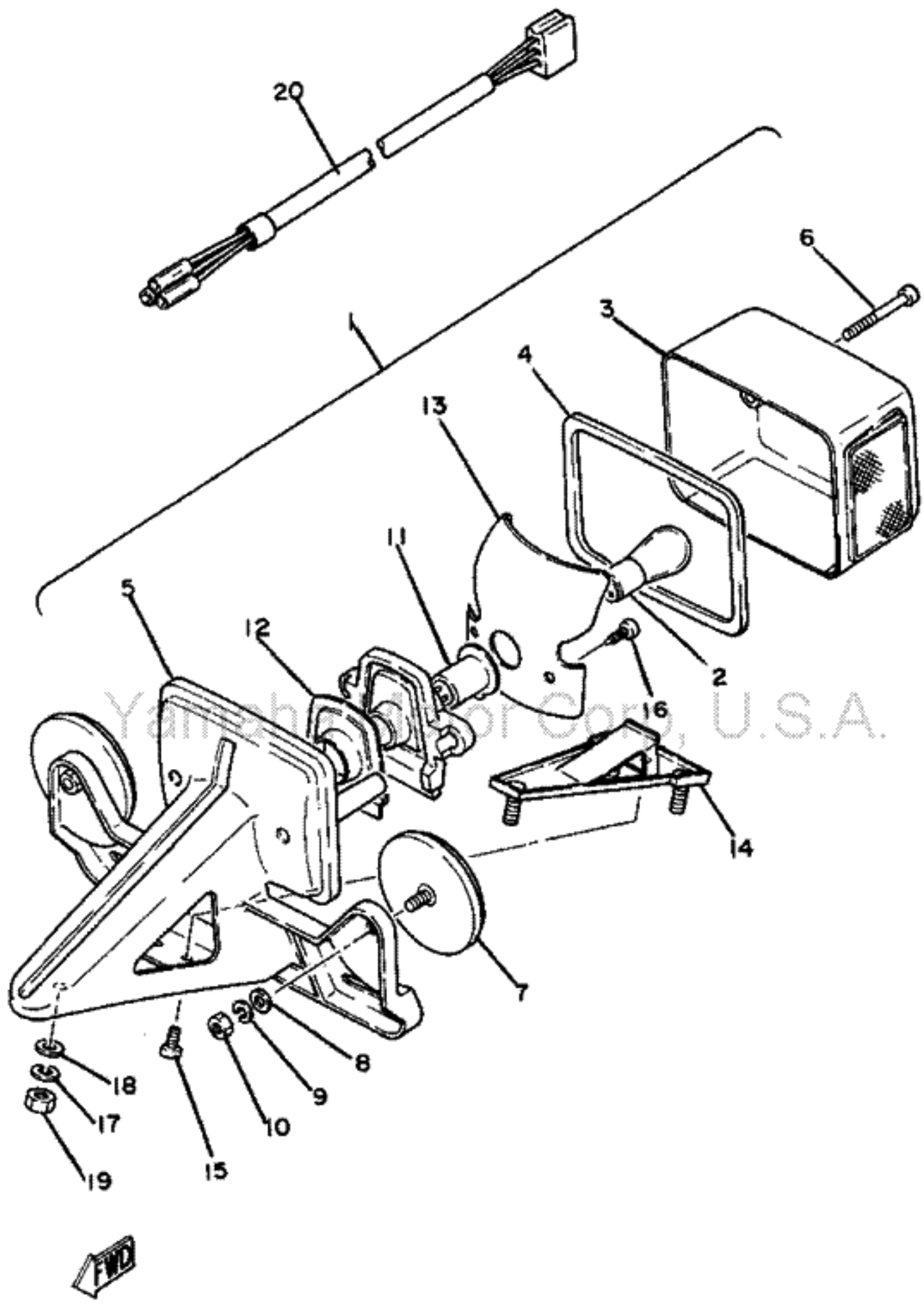

Item	Part #	Description	Notes	Req	
1	3Y1-84500-60-00	TAILLIGHT ASS'Y		1	ADD TO WISH LIST 
2	1M1-84514-60-00	BULB (6V-32/3CP)		1	ADD TO WISH LIST 
3	1M1-84521-60-00	LENS, TAILLIGHT		1	ADD TO WISH LIST 
4	3Y1-84545-00-00	GASKET, LENS		1	ADD TO WISH LIST 
5	3Y1-84551-60-00	BRACKET, LICENSE	BLACK	1	ADD TO WISH LIST 
6	3Y1-84524-00-00	SCREW, LENS FITTING		2	ADD TO WISH LIST 
7	449-85131-01-00	REFLECTOR, REAR 1		2	ADD TO WISH LIST 
8	92901-05200-00	WASHER, PLAIN		2	ADD TO WISH LIST 
9	92903-05100-00	WASHR, SPRING (92901-05100)		2	ADD TO WISH LIST 
10	95302-05600-00	NUT		2	ADD TO WISH LIST 
11	3Y1-84536-00-00	SOCKET CORD ASS'Y		1	ADD TO WISH LIST 
12	3Y1-84554-00-00	WASHER, SPECIAL		1	ADD TO WISH LIST 
13	3Y1-84531-00-00	REFLECTOR, TAILLIGHT		1	ADD TO WISH LIST 
14	3Y1-84552-00-00	BOLT, FITTING		1	ADD TO WISH LIST 
15	98901-04008-00	SCREW, BIND		1	ADD TO WISH LIST 
16	97701-40114-00	SCREW, PAN HEAD TAPPING		2	ADD TO WISH LIST 
17	92903-06100-00	WASHER, SPRING (92902-06100)		3	ADD TO WISH LIST 
18	90201-06055-00	WASHER, PLATE		3	ADD TO WISH LIST 
19	95302-06600-00	NUT		3	ADD TO WISH LIST 
20	3Y1-84517-00-00	CORD, TAILLIGHT		1	ADD TO WISH LIST 

MOTORCYCLE
M7-069

**INTRODUCTION
TO EPA**

This bulletin is intended to present a general overview of the current policies of the EPA and their effect on Yamaha's motorcycle production and you, the Yamaha motorcycle dealers', sales and service. For some of you who attended the service seminars, this will be a summary. For others this may be your introduction. Please read this bulletin carefully. If any questions arise do not hesitate to contact your District Service Representative, who can go into greater detail.

I. THE EMISSIONS REGULATIONS

A. The 1978 regulations.

The emissions regulations will apply to motorcycles with engines 50cc and larger, manufactured on or after January 1, 1978, which are designed for street use. Date of manufacture can be determined from the Federal Safety Compliance label located on the head pipe of the motorcycle.

B. These models can be further identified by two additional labels attached to the machine.

- 1) One label will carry EPA compliance information. The label will be located on the downtube or in the head pipe area.
- 2) The second label will carry tuning and service information. The label will be located near the service tools.

II. TYPES AND SOURCES OF MOTORCYCLE EMISSIONS

A. There are two basic types of pollutants that the EPA wishes to control.

- 1) Unburned hydrocarbons (HC).
HC is fuel that passes through the engine unburned. A small amount of HC also escapes from the fuel tank and carburetor vents. Crankcase fumes are also unburned HC due to fuel evaporating out of the motor oil. Blow-by gases enter the crankcase past the piston rings, and a small amount of fuel off the cylinder wall mixes with the motor oil after each combustion cycle. Misfiring or any engine problem that reduces combustion efficiency will increase HC emission levels.
- 2) Carbon monoxide (CO).
CO is a product of normal combustion. Rich fuel /air mixtures will increase CO output levels. CO is an odorless poisonous gas.

III. DEALER RESPONSIBILITIES FOR EMISSIONS CONTROL

A. Basic set-up and pre-delivery service.

Yamaha emissions controlled engines will be run, adjusted and preset for emissions control at the factory. As in the past, the dealer must perform set-up and pre-delivery servicing of the machine. Due to the new regulations we are using a new dealer set-up and pre-delivery checklist. This new sheet is included in this

package and details pre-delivery servicing. Technical bulletin number M7-067 will be issued along with one package of the new checklist forms. It will give more information on use of the new checklist. Strict adherence to these instructions is required to ensure that the EPA regulations are met. The part number for the new checklist is LIT-11161-00-78 and they are available in tablets of 50 sets for no charge.

DESCRIPTION	PART NUMBER	PRICE
Dealer Set-Up and Pre-Delivery Checklist Tablets of 50 sets	LIT-11161-00-78	No Charge Order only as necessary

DISCARD ALL OLD UNUSED CHECKLISTS. USE ONLY THE NEW CHECKLIST.

B. Basic service and periodic maintenance.

Proper periodic service adjustments and checks at the specified time intervals or odometer readings are essential to maintain minimum emissions levels. These intervals are specified in both the owner's manual and service manual for each model. Improper adjustment or lack of adjustment to these items can increase emissions output as well as decrease performance and economy. Four stroke models are equipped with idle mixture limiter caps. Do not remove them or adjust the carburetor mixture setting.

C. Tools and equipment required to service emissions control systems.

At the present time only the following items are required in addition to the hand tools and special tools necessary to perform routine service operations.

1. Vacuum sensing equipment — for carburetor synchronization
2. Timing light (strobe light) — for checking and setting ignition spark timing
3. Tachometer — for setting idle speed and checking the operation of the governor assembly.

D. Tampering with emissions controlled motorcycles.

IMPORTANT NOTE:

Tampering with the emissions control system of an emissions controlled motorcycle by a motorcycle dealer or repair shop is prohibited by the Clean Air Act.

Tampering is defined as any modification to the emission control system that causes the motorcycle to exceed the applicable emission standard.

Tampering prior to the delivery of the motorcycle to the retail purchaser subjects the dealer to a possible fine of up to \$10,000. Tampering after delivery of the motorcycle to the retail purchaser subjects the dealer or repair shop to a possible fine of up to \$2,500.

Item	Part #	Description	Notes	Req
No Parts List for Image				ADD TO WISH LIST 

TECHNICAL BULLETIN

FILE GENERAL

DATE 6/27/80

BUL M80-031

The tampering law does not prohibit the sale and/or use of aftermarket parts and accessories. However, for maximum protection against a tampering charge, a dealer should receive satisfactory assurances from the aftermarket manufacturer that installation of an aftermarket part or accessory will not constitute tampering.

All Yamaha parts and accessories are designed and/or tested to specific models so that their use on these models will not constitute tampering. Yamaha will not comment upon whether the use of specific non-Yamaha parts and/or accessories constitutes tampering.

In addition to Federal anti-tampering provisions in the Clean Air Act, some states have state anti-tampering laws. You are responsible for knowing your own state laws regarding tampering.

Yamaha is concerned with preserving the environment and is continually striving to reduce emission levels while maintaining good performance and reliability. It is Yamaha's request that the dealer network also strive to minimize emissions and help increase consumer satisfaction.

Additional information regarding emissions controls and tools and equipment will be provided from time to time as required and as information is available. Specific information for dealers who sell and service machines used at higher altitudes will be made available.

GENERAL

NEW LOCK-NUMBER LOCATION AND FORMAT

The lock/key number of the affected models has been relocated on the main switch, and the format for identifying the proper key blanks has been changed.

AFFECTED MODELS

All SR250G and XJ650G
Most 1981 street-legal models

PROCEDURE

The lock/key number on the affected models is located on the bottom of the main switch; see Photo. On most models, the number can be seen with the switch installed on the motorcycle; some models, however, require the removal of some parts to reveal the number.

The new lock-number format has a letter prefix indicating which key blank is to be used when cutting a new key. There are six letters used, A through F; hence, there are six types of new key blanks. After determining the prefix letter, refer to the chart below for the part number of the proper key blank.

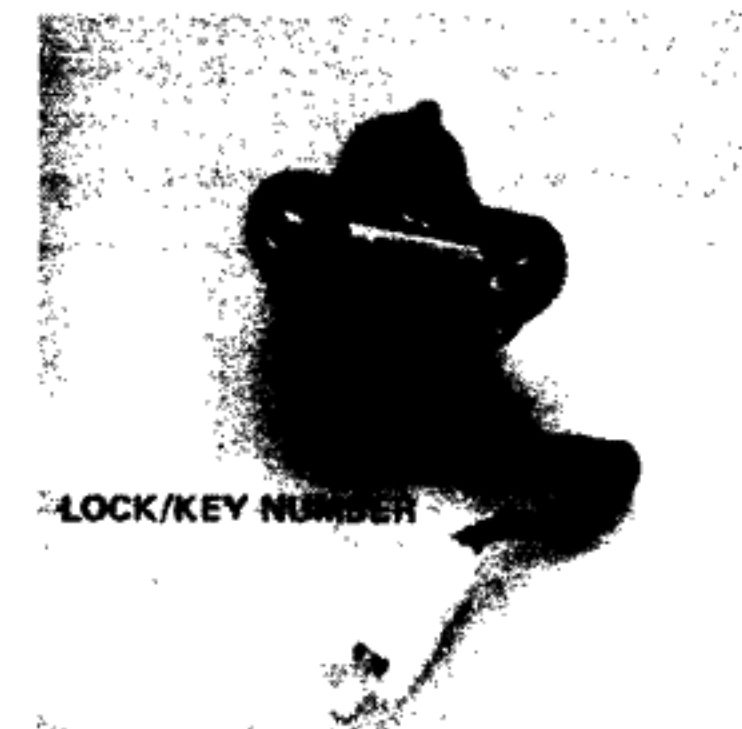

PARTS INFORMATION

PREFIX LETTER	PART NUMBER	DESCRIPTION	DEALER COST
A	90890-55813-00	Key Blank	
B	90890-55814-00	Key Blank	
C	90890-55815-00	Key Blank	
D	90890-55816-00	Key Blank	
E	90890-55817-00	Key Blank	
F	90890-55818-00	Key Blank	

Item	Part #	Description	Notes	Req
No Parts List for Image				ADD TO WISH LIST 

TECHNICAL BULLETIN

FILE GENERAL DATE 6/27/80 BUL M80-031

The following are updated lists of previously introduced key-blank numbers and their part numbers.

LOCK/KEY NUMBER	KEY BLANK	LOCK/KEY NUMBER	KEY BLANK	LOCK/KEY NUMBER	KEY BLANK
221 ~ 227	211	3491 ~ 3500	1212	4151 ~ 4160	1221
228 ~ 234	212	3501 ~ 3530	1215	4161 ~ 4190	1221
1209 ~ 1215	221	3531 ~ 3550	1215	4191 ~ 4200	1221
1711 ~ 1725	111	3551 ~ 3580	1219	4201 ~ 4210	1220
1726 ~ 1750	911	3581 ~ 3600	1219	4211 ~ 4240	1220
1751 ~ 1775	921	3601 ~ 3630	1216	4241 ~ 4250	1220
1776 ~ 1800	151	3631 ~ 3650	1216	4251 ~ 4260	1222
2109 ~ 2115	222	3651 ~ 3680	1220	4261 ~ 4290	1222
2311 ~ 2318	412	3681 ~ 3700	1220	4291 ~ 4300	1222
2411 ~ 2418	411	3701 ~ 3730	1221	4301 ~ 4320	1211
2550 ~ 2557	522	3731 ~ 3750	1221	4321 ~ 4350	1211
2611 ~ 2625	112	3751 ~ 3760	1213	4351 ~ 4370	1213
2626 ~ 2650	912	3761 ~ 3790	1213	4371 ~ 4400	1213
2651 ~ 2675	922	3791 ~ 3800	1213	4401 ~ 4420	1212
2676 ~ 2700	152	3801 ~ 3830	1222	4421 ~ 4450	1212
2750 ~ 2757	512	3831 ~ 3850	1222	4451 ~ 4470	1214
2840 ~ 2847	511	3851 ~ 3860	1214	4471 ~ 4500	1214
3101 ~ 3130	1211	3861 ~ 3890	1214	4501 ~ 4520	1215
3131 ~ 3150	1211	3891 ~ 3900	1214	4521 ~ 4550	1215
3151 ~ 3180	1213	3901 ~ 3910	1215	4551 ~ 4570	1217
3181 ~ 3200	1213	3911 ~ 3940	1215	4571 ~ 4600	1217
3201 ~ 3230	1212	3941 ~ 3950	1215	4601 ~ 4620	1216
3231 ~ 3250	1212	3951 ~ 3960	1217	4621 ~ 4650	1216
3251 ~ 3280	1214	3961 ~ 3990	1217	4651 ~ 4670	1218
3281 ~ 3300	1214	3991 ~ 4000	1217	4671 ~ 4700	1218
3301 ~ 3330	1217	4001 ~ 4010	1216	4701 ~ 4720	1219
3331 ~ 3350	1217	4011 ~ 4040	1216	4721 ~ 4750	1219
3351 ~ 3360	1211	4041 ~ 4050	1216	4751 ~ 4770	1221
3361 ~ 3390	1211	4051 ~ 4060	1218	4771 ~ 4800	1221
3391 ~ 3400	1211	4061 ~ 4090	1218	4801 ~ 4820	1220
3401 ~ 3430	1218	4091 ~ 4100	1218	4821 ~ 4850	1220
3431 ~ 3450	1218	4101 ~ 4110	1219	4851 ~ 4870	1222
3451 ~ 3460	1212	4111 ~ 4140	1219	4871 ~ 4900	1222
3461 ~ 3490	1212	4141 ~ 4150	1219		

FILE GENERAL DATE 6/27/80 BUL M80-031

BLANK NUMBER	PART NUMBER	DESCRIPTION	DEALER COST
111	BKY-55901-01-11	Key Blank	\$0.50
112	BKY-55902-01-12	Key Blank	0.50
151	BKY-55927-01-51	Key Blank	0.50
152	BKY-55928-01-52	Key Blank	0.50
211	BKY-55903-02-11	Key Blank	0.50
212	BKY-55904-02-12	Key Blank	0.50
221	BKY-55905-02-21	Key Blank	0.50
222	BKY-55906-02-22	Key Blank	0.50
411	BKY-55909-04-11	Key Blank	0.50
412	BKY-55910-04-12	Key Blank	0.50
511	BKY-55913-05-11	Key Blank	0.50
512	BKY-55914-05-12	Key Blank	0.50
911	BKY-55925-09-11	Key Blank	0.50
912	BKY-55926-09-12	Key Blank	0.50
921	BKY-55929-09-21	Key Blank	0.50
922	BKY-55930-09-22	Key Blank	0.50
1211	90890-55801-00	Key Blank	0.54
1212	90890-55802-00	Key Blank	0.54
1213	90890-55803-00	Key Blank	0.54
1214	90890-55804-00	Key Blank	0.54
1215	90890-55805-00	Key Blank	0.54
1216	90890-55806-00	Key Blank	0.54
1217	90890-55807-00	Key Blank	0.54
1218	90890-55808-00	Key Blank	0.54
1221	90890-55811-00	Key Blank	0.54
1222	90890-55812-00	Key Blank	0.54

Item	Part #	Description	Notes	Req
No Parts List for Image				ADD TO WISH LIST 

TECHNICAL BULLETIN

FILE GENERAL

DATE 6/20/80

BUL M80-030

SPECIAL TOOLS EMISSIONS-RELATED

The following tools are now available from Yamaha Parts Distributors Inc.

REPLACEMENT PROBE ADAPTOR

This tool is a replacement part for the Allen Exhaust Gas Analyzer. It is used to connect the multiprobe adaptor to multicylinder-engine exhaust systems. It is available from your YPDI warehouse.

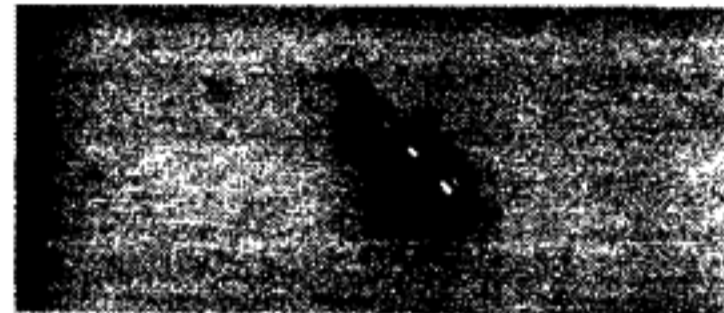

REPLACEMENT STUD

This replacement stud for the heavy-duty Rivnut® installation tool is now available from the Cypress warehouse only.



PARTS INFORMATION

PART NUMBER	DESCRIPTION	DEALER COST
TLM-11080-50-00	Probe Adaptor	
TLM-11080-45-01	Rivnut® Tool Stud	

FILE MOTORCYCLE -- GENERAL

DATE 3/20/81

BUL M81-014

GENERAL LOCK/KEY NUMBER

The lock/key number on the bottom of the main switch may be washed off by the excessive pressure of high-pressure spray washes. If a customer loses his key, he cannot have another made unless he has this number.

AFFECTED MODELS

All SR250G

All XJ650G

All 1981 Street-legal models

Please inform your customers of this problem. Advise them to record the lock/key number in their owner's manuals and on their warranty registration forms. In this way, a customer will always have the number even if the decal washes off the main switch.

Yamaha Motor Corp, U.S.A.

Item	Part #	Description	Notes	Req
No Parts List for Image				ADD TO WISH LIST 

TECHNICAL BULLETIN

MOTORCYCLE DATE 2/4/83 BUL M83-005

SR/TT/XT250 CRANKSHAFT OIL-GALLERY MODIFICATION

The action of the crankshaft on some affected models may act as a centrifugal pump, drawing too much oil; this means there is less oil available for delivery to the top end. Installation of a special roll pin in the crankshaft will correct this. The crankshaft oil gallery will be partially restricted, reducing the drawing action of the crankshaft so more oil will be available for delivery to the top end. **This modification will not adversely affect the lubrication of the crankshaft; the crankshaft will be adequately lubricated.**

Dealers are requested to install the roll pin in all unsold affected models in their inventories. When customer-owned machines come in for service, install a roll pin in them. Warranty will cover this procedure in all affected models.

AFFECTED MODELS

SR250G: All	TT250G: All	XT250G: All
SR250H: All	TT250H: All	XT250H: All
SR250TH: All	TT250J: All	XT250J: All
SR250J: All		XT250K: All

PROCEDURE

1. Inspect the engine serial number to ensure that this modification has yet to be performed; a punch mark over the serial-number dash indicates that the procedure has already been done.
2. Drain the oil from the motorcycle, remove the kick starter, and remove the right-hand side cover.
3. With a properly sized punch, drive the roll pin into the crankshaft oil gallery as shown in illustration 1. The pin should be 7mm from the end of the crankshaft

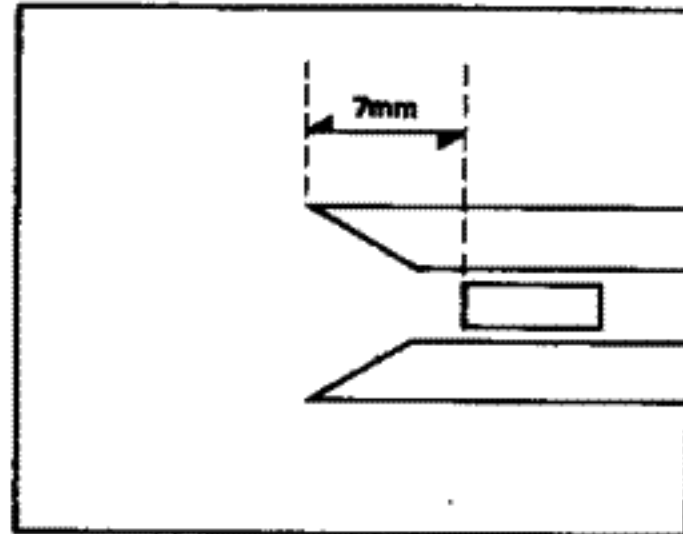

ILLUSTRATION 1

4. Inspect the crankshaft oil seal in the right-hand crankcase cover; see illustration 2. If the seal is worn, damaged, or cocked in its boss, replace or reposition it. **This oil seal must be inspected.** The engine will be severely damaged if the seal is worn, damaged, or improperly positioned.

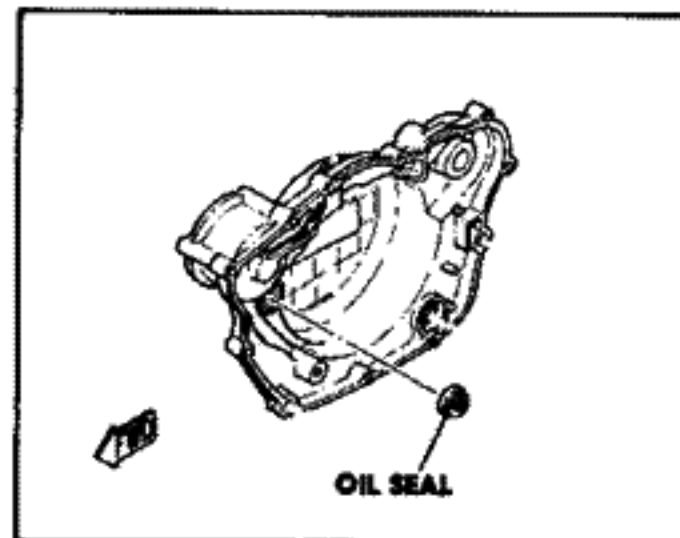

ILLUSTRATION 2

5. Reinstall the crankcase cover and kick starter; use a new crankcase cover gasket.

MOTORCYCLE DATE 2/4/83 BUL M83-005

6. Add 1300cc of oil, start the machine, and check the oil level. Add oil as necessary.
7. Make a punch mark above the dash in the engine serial number to indicate that this modification has been performed on the unit; see illustration 3.

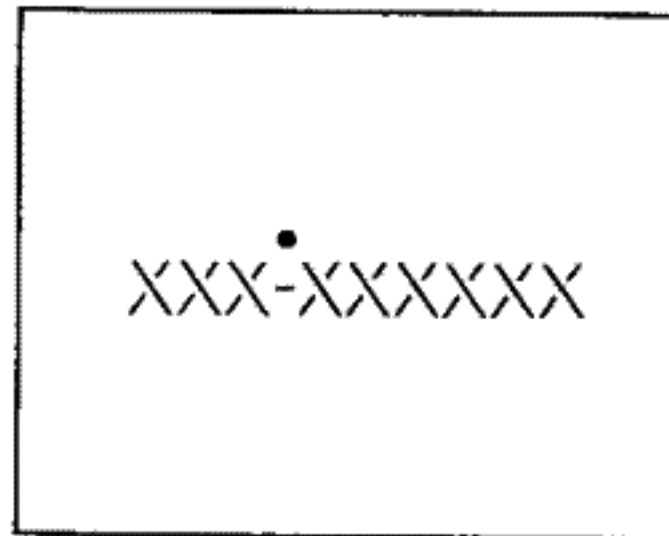

ILLUSTRATION 3

8. Remove the screw and inspect the oil gallery shown in illustration 4. Make sure there are no particles blocking the gallery.

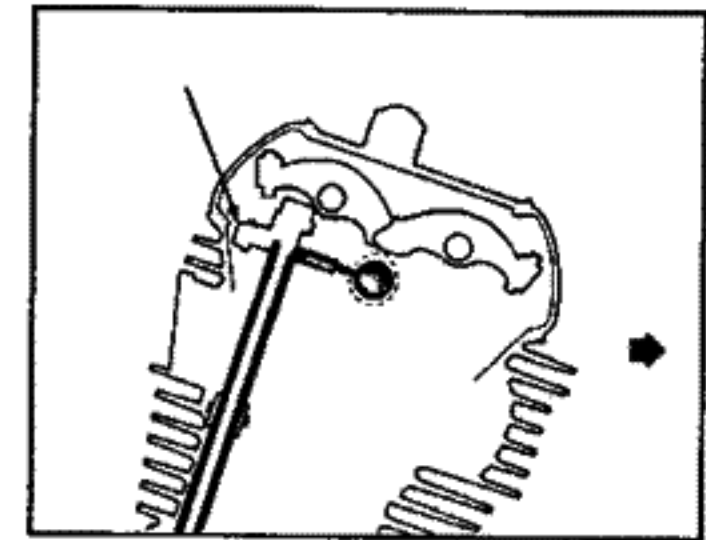

ILLUSTRATION 4

PARTS INFORMATION

PART NUMBER	DESCRIPTION	REMARKS	DEALER COST
91609-60020-00	Roll Pin		
93101-14092-00	Oil Seal		
3Y6-15461-00-00	Crankcase Cover Gasket	Fits SR250	
3Y1-15461-00-00	Crankcase Cover Gasket	Fits TT250 and XT250	

WARRANTY

The warranty labor allowance for this procedure is 0.5 hours. The problem code is 90EH.

To receive credit, follow standard service-bulletin procedures.

90EH
(05) What problem code best describes the failure?









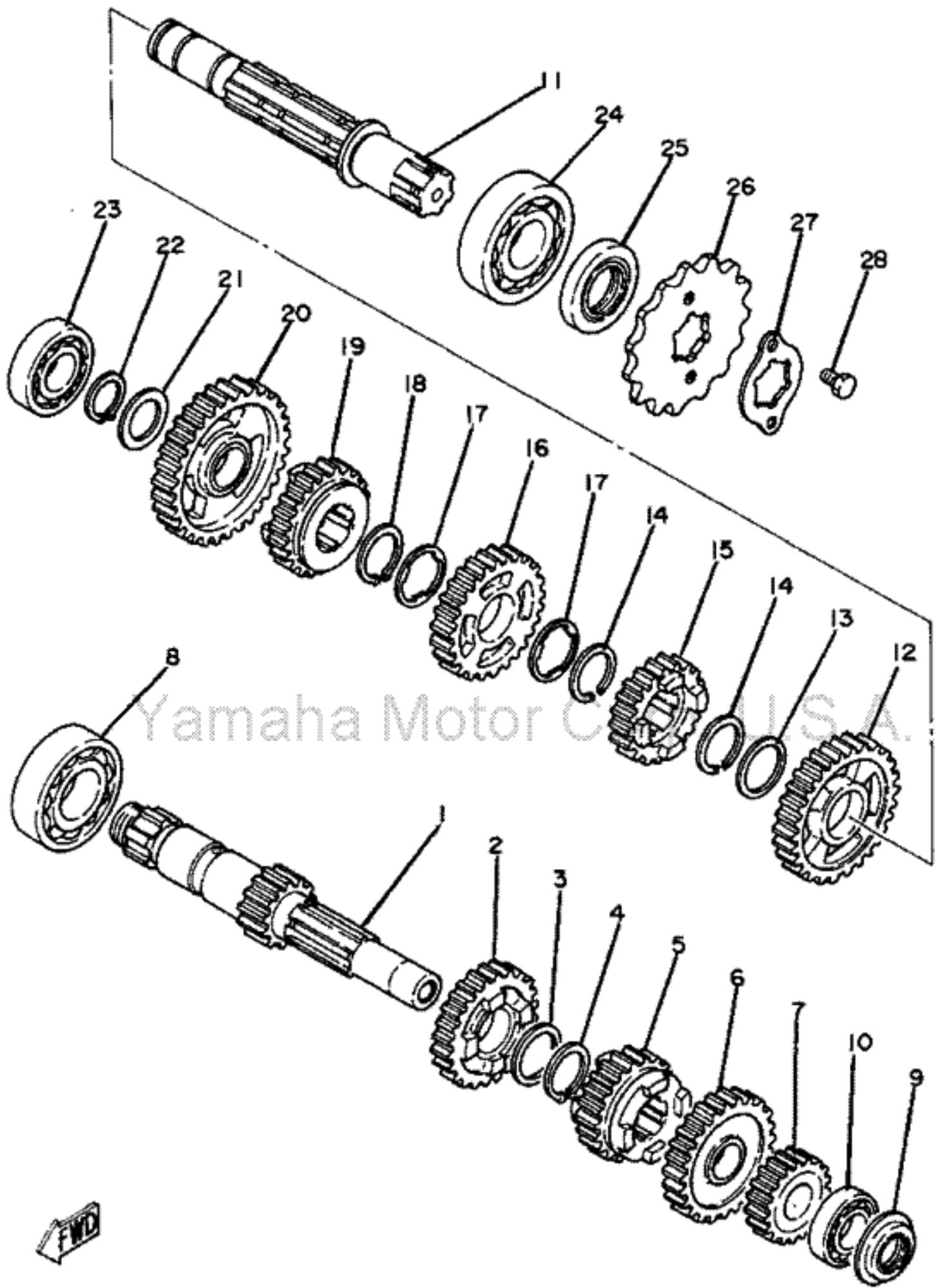















0.5
HOURS TENTH

SERVICE COPY	SER MGR	MECH	MECH	MECH	BINDER
OFFICE COPY	GEN MGR	SALES	PARTS	BINDER	PAGE 1 OF 2









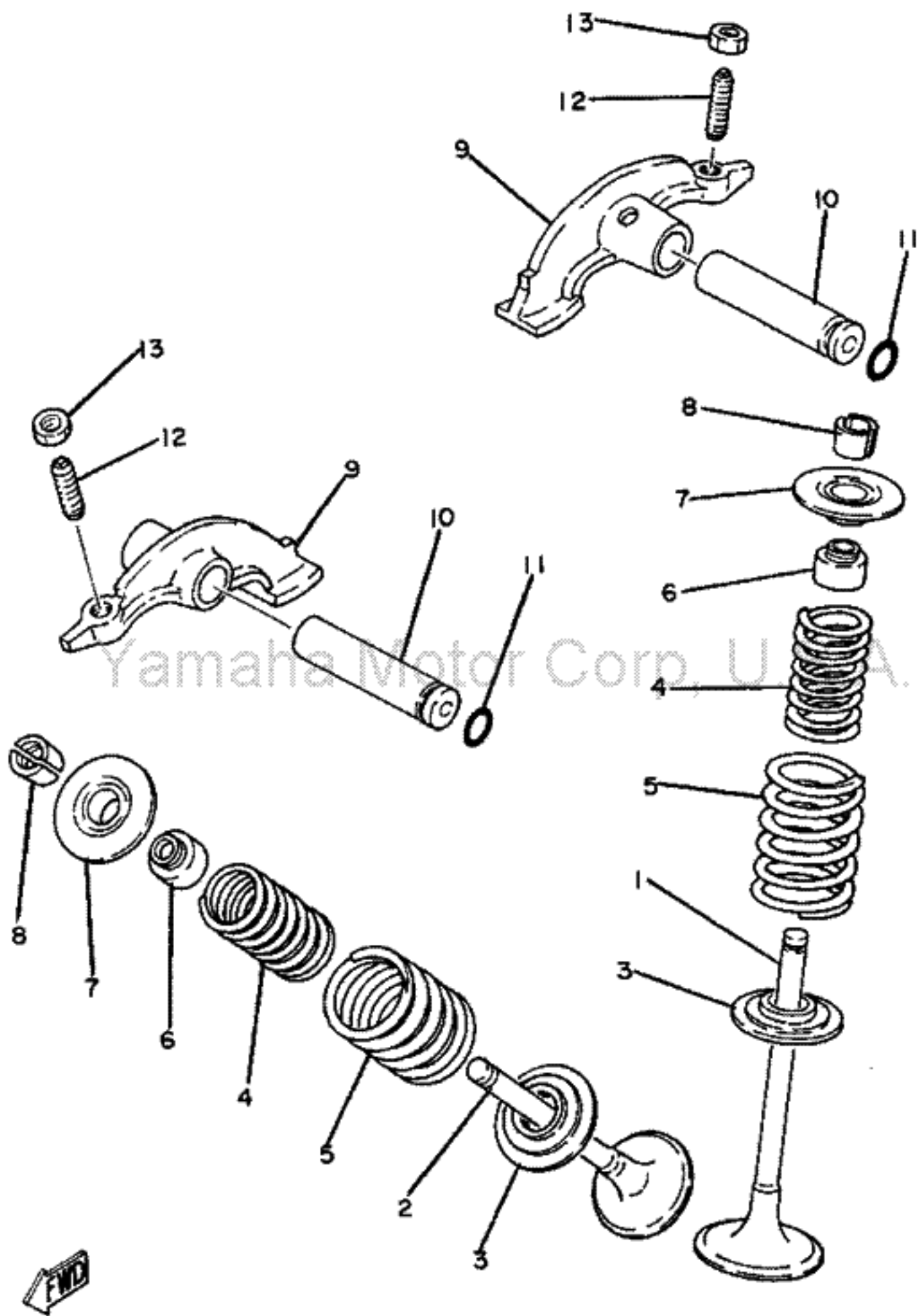





PAGE 2 OF 2

Item	Part #	Description	Notes	Req
No Parts List for Image				ADD TO WISH LIST 



Item	Part #	Description	Notes	Req	
1	3Y1-17411-00-00	AXLE, MAIN (14T)		1	ADD TO WISH LIST 
2	3Y1-17141-00-00	GEAR, 4TH PINION (26T)		1	ADD TO WISH LIST 
3	90201-22793-00	WASHER, PLATE		1	ADD TO WISH LIST 
4	93410-22039-00	CIRCLIP		1	ADD TO WISH LIST 
5	3Y1-17131-00-00	GEAR, 3RD PINION (23T)		1	ADD TO WISH LIST 
6	3Y1-17151-00-00	GEAR, 5TH PINION (28T)		1	ADD TO WISH LIST 
7	3Y1-17121-00-00	GEAR, 2ND PINION (19T)		1	ADD TO WISH LIST 
8	93306-20541-00	BEARING (B6205)		1	ADD TO WISH LIST 
9	93101-17093-00	OIL SEAL		1	ADD TO WISH LIST 
10	93306-00302-00	BEARING (93306-00301)		1	ADD TO WISH LIST 
11	3Y1-17402-00-00	DRIVE AXLE ASS'Y		1	ADD TO WISH LIST 
12	3Y1-17221-00-00	GEAR, 2ND WHEEL (32T)		1	ADD TO WISH LIST 
13	90201-25287-00	WASHER, PLATE		1	ADD TO WISH LIST 
14	93440-25019-00	CIRCLIP (93440-25008)		2	ADD TO WISH LIST 
15	3Y1-17251-00-00	GEAR, 5TH WHEEL (23T)		1	ADD TO WISH LIST 
16	3Y1-17231-00-00	GEAR, 3RD WHEEL (29T)		1	ADD TO WISH LIST 
17	90209-22191-00	WASHER		2	ADD TO WISH LIST 
18	93410-25010-00	CIRCLIP		1	ADD TO WISH LIST 
19	3Y1-17241-00-00	GEAR, 4TH WHEEL (26T)		1	ADD TO WISH LIST 
20	3Y1-17211-00-00	GEAR, 1ST WHEEL (37T)		1	ADD TO WISH LIST 
21	90201-20276-00	WASHER, PLATE		1	ADD TO WISH LIST 
22	93410-20009-00	CIRCLIP		1	ADD TO WISH LIST 
23	93306-00401-00	BEARING (B6004)		1	ADD TO WISH LIST 
24	93306-30525-00	BEARING (B6305)		1	ADD TO WISH LIST 
25	93102-25208-00	OIL SEAL		1	ADD TO WISH LIST 
26	3Y1-17461-50-00	SPROCKET, DRIVE (15T)		1	ADD TO WISH LIST 
27	3Y1-17456-00-00	HOLDER, SPROCKET		1	ADD TO WISH LIST 
28	97322-06010-00	BOLT		2	ADD TO WISH LIST 



Item	Part #	Description	Notes	Req	
1	3Y1-12111-00-00	VALVE, INTAKE		1	ADD TO WISH LIST 
2	3Y1-12121-00-00	VALVE, EXHAUST		1	ADD TO WISH LIST 
3	3Y1-12116-00-00	SEAT, VALVE SPRING		2	ADD TO WISH LIST 
4	3Y1-12113-01-00	SPRING, VALVE INNER		2	ADD TO WISH LIST 
5	3Y1-12114-01-00	SPRING, VALVE OUTER		2	ADD TO WISH LIST 
6	1J7-12119-01-00	SEAL, VALVE STEM		2	ADD TO WISH LIST 
7	3Y1-12117-01-00	RETAINER, VALVE SPRING (3Y1-12117-00)		2	ADD TO WISH LIST 
8	1J7-12118-00-00	COTTER, VALVE		4	ADD TO WISH LIST 
9	3Y1-12151-09-00	NOT AVAILABLE			ADD TO WISH LIST 
9	99999-01443-00	ROCKER ARM KIT THIS KIT INCLUDES THE FOLLOWING:			ADD TO WISH LIST 
9	31G-12159-01-00	SCREW, VALVE ADJUST		1	ADD TO WISH LIST 
9	31G-12158-00-00	NUT		1	ADD TO WISH LIST 
10	3Y1-12156-00-00	SHAFT, ROCKER		2	ADD TO WISH LIST 
11	93210-09165-00	O-RING		2	ADD TO WISH LIST 
12	3Y1-12159-00-00	SCREW, VALVE ADJUST		2	ADD TO WISH LIST 
13	90170-06128-00	NUT		2	ADD TO WISH LIST 