



# LED-TV

Chassis : N92A

Model : UE32C5\*\*\*  
UE37C5\*\*\*  
UE40C5\*\*\*  
UE46C5\*\*\*  
UE32C4000P\*

# *SERVICE* Manual

## TFT-LED TV



UE40C5\*\*\*

## Contents

1. Precautions
2. Product specifications
3. Disassembly and Reassembly
4. Troubleshooting
5. Exploded View & Part List
6. Wiring Diagram

# Contents

<b>1. Precautions</b> .....	<b>1-1</b>
1-1. Safety Precautions .....	1-1
1-2. Servicing Precautions .....	1-2
1-3. Electrostatically Sensitive Devices (ESD) Precautions .....	1-2
1-4. Installation Precautions .....	1-3
<b>2. Product specifications</b> .....	<b>2-1</b>
2-1. Feature & Specifications .....	2-1
2-2. Detail Factory Option .....	2-6
2-3. Accessories .....	2-7
2-4. New Features explanation .....	2-10
<b>3. Disassembly and Reassembly</b> .....	<b>3-1</b>
3-1. Disassembly and Reassembly .....	3-1
<b>4. Troubleshooting</b> .....	<b>4-1</b>
4-1. Troubleshooting .....	4-1
4-2. Alignments and Adjustments .....	4-25
4-3. Factory Mode Adjustments .....	4-26
4-4. White Balance .....	4-34
4-5. White Ratio (Balance) Adjustment .....	4-34
4-6. Servicing Information .....	4-35
4-7. How To Upgrade Sub Micom With Ddc Manager .....	4-36
4-8. PCB diagram .....	4-38
<b>5. Exploded View &amp; Part List</b> .....	<b>5-1</b>
5-1. UE32C5*** Exploded View .....	5-1
5-2. UE32C5*** Parts List .....	5-3
5-3. UE37C5*** Exploded View .....	5-10
5-4. UE37C5*** Parts List .....	5-12
5-5. UE40C5*** Exploded View .....	5-19
5-6. UE40C5*** Parts List .....	5-21
5-7. UE46C5*** Exploded View .....	5-28
5-8. UE46C5*** Parts List .....	5-30
5-9. UE32C4000P* Exploded View .....	5-38
5-10. UE32C4000P* Parts List .....	5-40
<b>6. Wiring Diagram</b> .....	<b>6-1</b>
6-1. Wiring Diagram .....	6-1
6-2. Connector .....	6-3
6-3. Connector Functions .....	6-5
6-4. Cables .....	6-5



**GSPN (Global Service Partner Network)**

Area	Web Site
North America	<a href="http://service.samsungportal.com">http://service.samsungportal.com</a>
Latin America	<a href="http://latin.samsungportal.com">http://latin.samsungportal.com</a>
CIS	<a href="http://cis.samsungportal.com">http://cis.samsungportal.com</a>
Europe	<a href="http://europe.samsungportal.com">http://europe.samsungportal.com</a>
China	<a href="http://china.samsungportal.com">http://china.samsungportal.com</a>
Asia	<a href="http://asia.samsungportal.com">http://asia.samsungportal.com</a>
Mideast & Africa	<a href="http://mea.samsungportal.com">http://mea.samsungportal.com</a>

**This Service Manual is a property of Samsung Electronics Co.,Ltd.**  
Any unauthorized use of Manual can be punished under applicable  
International and/or domestic law.

**© 2010 Samsung Electronics Co.,Ltd.**  
**All rights reserved.**  
Printed in Korea  
P/N: BN82-00755A-00

## 2. Product specifications

### 2-1. Feature & Specifications

Model	UE32C5***	
<b>Feature</b>		
<ul style="list-style-type: none"> <li>▶ DTV/ATV, 4-HDMI, 1-Component, 1-A/V, D-SUB, 1-SCART, 2-USB2.0, CI Slot</li> <li>▶ Brightness : 450 cd/m<sup>2</sup></li> <li>▶ High Contrast Ratio : 50,000:1</li> <li>▶ Response Time : 4.5ms</li> </ul>		
<b>Specifications</b>		
Item	Description	
LCD Panel	32inch FHD 60Hz	
Scanning Frequency	Horizontal : 30 kHz ~ 80 kHz (Automatic) Vertical : 47 Hz ~ 75 Hz (Automatic)	
Display Colors	16.7M color	
Maximum resolution	Horizontal : 1920 Pixels Vertical : 1080 pixels	
Input Signal	Analog 0.7 Vp-p ± 5% positive at 75Ω , internally terminated	
Input Sync Signal	H/V Separate, TTL, P. or N.	
Maximum Pixel Clock rate	74.25MHz	
Active Display Horizontal/Vertical	27.50 x 15.47 inches (698.4(H) x 392.85(V) mm)	
AC power voltage & Frequency	AC 100V ~ 240V, 50/60Hz	
Power Consumption	Under 110W (Under 0.3W, Stand by)	
Dimensions Set (W x D x H)	30.9 x 9.4 x 21.6 inches (785 x 240 x 550 mm)_with stand 30.9 x 1.2 x 19.3 inches (785 x 29.9 x 491 mm)_without stand	
Weight	24.25 lbs (11kg)_with stand 18.08 lbs (8.2kg)_without stand	
TV System	Tuning	Frequency Synthesize (Refer to detailed Frequency Table)
	System	DVB-T/C, PAL, SECAM, NT4.43
	Sound	BG, DK, L/L', NICAM, MPEG1, DD, DD+, HE-AAC
Environmental Considerations	Operating Temperature : 32°F ~ 122°F (0°C ~ 50°C) Operating Humidity : 10% ~ 90%, non-condensing Storage temperature : -4°F ~ 140°F (-20°C ~ 60°C) Storage Humidity : 10% ~ 90%	
Audio Spec.	<ul style="list-style-type: none"> <li>- MAX Internal Audio Output Power : Each 10W(Left/Right)</li> <li>- BASS Control Range : -8 dB ~ + 8dB</li> <li>- TREBLE Control Range : -8 dB ~ +8 dB</li> <li>- Headphone Out : 10 mW MAX</li> <li>- Output Frequency : RF : 80 Hz ~ 15 kHz AV/Componet/HDMI : 80 Hz ~ 20 kHz</li> </ul>	
<b>Note:</b> DLNA, Dolby Digital+, Game Mode, Film Mode, Energy Saving, Anynet+		

2. Product specifications

Model		UE37C5***	
Feature			
<ul style="list-style-type: none"> <li>▶ DTV/ATV, 4-HDMI, 1-Component, 1-A/V, D-SUB, 1-SCART, 2-USB2.0, CI Slot</li> <li>▶ Brightness : 450 cd/m<sup>2</sup></li> <li>▶ High Contrast Ratio : 50,000:1</li> <li>▶ Response Time : 4.5 ms</li> </ul>			
Specifications			
Item		Description	
LCD Panel		37inch FHD 60Hz	
Scanning Frequency		Horizontal : 30 kHz ~ 80 kHz (Automatic) Vertical : 47 Hz ~ 63 Hz (Automatic)	
Display Colors		16.7M color	
Maximum resolution		Horizontal : 1920 Pixels Vertical : 1080 pixels	
Input Signal		Analog 0.7 Vp-p ± 5% positive at 75Ω , internally terminated	
Input Sync Signal		H/V Separate, TTL, P. or N.	
Maximum Pixel Clock rate		74.25MHz	
Active Display Horizontal/Vertical		32.26 x 18.15 inches (819.36(H) x 460.89(V) mm)	
AC power voltage & Frequency		AC 100V ~ 240V, 50/60Hz	
Power Consumption		Under 120W (Under 0.3W, Stand by)	
Dimensions Set (W x D x H)		35.7 x 10.0 x 24.4 inches (908 x 255 x 621 mm)_with stand 35.7 x 1.2 x 22.1 inches (908 x 29.9 x 561 mm)_without stand	
Weight		31.30 lbs (14.2kg)_with stand 23.37 lbs (10.6kg)_without stand	
TV System		Tuning	Frequency Synthesize (Refer to detailed Frequency Table)
		System	DVB-T/C, PAL, SECAM, NT4.43
		Sound	BG, DK, L/L', NICAM, MPEG1, DD, DD+, HE-AAC
Environmental Considerations		Operating Temperature : 32°F ~ 122°F (0°C ~ 50°C) Operating Humidity : 10% ~ 90%, non-condensing Storage temperature : -4°F ~ 140°F (-20°C ~ 60°C) Storage Humidity : 10% ~ 90%	
Audio Spec.		<ul style="list-style-type: none"> <li>- MAX Internal Audio Output Power : Each 10W(Left/Right)</li> <li>- BASS Control Range : -8 dB ~ + 8dB</li> <li>- TREBLE Control Range : -8 dB ~ +8 dB</li> <li>- Headphone Out : 10 mW MAX</li> <li>- Output Frequency : RF : 80 Hz ~ 15 kHz AV/Componet/HDMI : 80 Hz ~ 20 kHz</li> </ul>	
<b>Note:</b> DLNA, Dolby Digital+, Game Mode, Film Mode, Energy Saving, Anynet+			

Model	UE40C5***	
<b>Feature</b>		
<ul style="list-style-type: none"> <li>▶ DTV/ATV, 4-HDMI, 1-Component, 1-A/V, D-SUB, 1-SCART, 2-USB2.0, CI Slot</li> <li>▶ Brightness : 450 cd/m<sup>2</sup></li> <li>▶ High Contrast Ratio : 50,000:1</li> <li>▶ Response Time : 4.5 ms</li> </ul>		
<b>Specifications</b>		
Item	Description	
LCD Panel	40inch FHD 60Hz	
Scanning Frequency	Horizontal : 30 kHz ~ 80 kHz (Automatic) Vertical : 47 Hz ~ 63 Hz (Automatic)	
Display Colors	16.7M color	
Maximum resolution	Horizontal : 1920 Pixels Vertical : 1080 pixels	
Input Signal	Analog 0.7 Vp-p ± 5% positive at 75Ω , internally terminated	
Input Sync Signal	H/V Separate, TTL, P. or N.	
Maximum Pixel Clock rate	74.25MHz	
Active Display Horizontal/Vertical	34.87 x 22.55 inches (885.6(H) x 19.61(V) mm)	
AC power voltage & Frequency	AC 100V ~ 240V, 50/60Hz	
Power Consumption	Under 130W (Under 0.3W, Stand by)	
Dimensions Set (W x D x H)	38.3 x 10.0 x 24.4 inches (972 x 255 x 621 mm)_with stand 38.3 x 1.2 x 23.5 inches (972 x 29.9 x 596 mm)_without stand	
Weight	34.61 lbs (15.7kg)_with stand 26.68 lbs (12.1kg)_without stand	
TV System	Tuning	Frequency Synthesize (Refer to detailed Frequency Table)
	System	DVB-T/C, PAL, SECAM, NT4.43
	Sound	BG, DK, L/L', NICAM, MPEG1, DD, DD+, HE-AAC
Environmental Considerations	Operating Temperature : 32°F ~ 122°F (0°C ~ 50°C) Operating Humidity : 10% ~ 90%, non-condensing Storage temperature : -4°F ~ 140°F (-20°C ~ 60°C) Storage Humidity : 10% ~ 90%	
Audio Spec.	<ul style="list-style-type: none"> <li>- MAX Internal Audio Output Power : Each 10W(Left/Right)</li> <li>- BASS Control Range : -8 dB ~ + 8dB</li> <li>- TREBLE Control Range : -8 dB ~ +8 dB</li> <li>- Headphone Out : 10 mW MAX</li> <li>- Output Frequency : RF : 80 Hz ~ 15 kHz AV/Componet/HDMI : 80 Hz ~ 20 kHz</li> </ul>	
<b>Note:</b> DLNA, Dolby Digital+, Game Mode, Film Mode, Energy Saving, Anynet+		

2. Product specifications

Model	UE46C5***	
<b>Feature</b>		
<ul style="list-style-type: none"> <li>▶ DTV/ATV, 4-HDMI, 1-Component, 1-A/V, D-SUB, 1-SCART, 2-USB2.0, CI Slot</li> <li>▶ Brightness : 450 cd/m<sup>2</sup></li> <li>▶ High Contrast Ratio : 50,000:1</li> <li>▶ Response Time : 4.5ms</li> </ul>		
<b>Specifications</b>		
Item	Description	
LCD Panel	46inch FHD 60Hz	
Scanning Frequency	Horizontal : 30 kHz ~ 80 kHz (Automatic) Vertical : 47 Hz ~ 63 Hz (Automatic)	
Display Colors	16.7M color	
Maximum resolution	Horizontal : 1920 Pixels Vertical : 1080 pixels	
Input Signal	Analog 0.7 Vp-p ± 5% positive at 75Ω , internally terminated	
Input Sync Signal	H/V Separate, TTL, P. or N.	
Maximum Pixel Clock rate	74.25MHz	
Active Display Horizontal/Vertical	40.08 x 22.55 inches (1018.08(H) x 572.67(V) mm)	
AC power voltage & Frequency	AC 100V ~ 240V, 50/60Hz	
Power Consumption	Under 130W (Under 0.3W, Stand by)	
Dimensions Set (W x D x H)	43.6 x 10.8 x 28.8 inches (1107 x 275 x 731 mm)_with stand 43.6 x 1.2 x 26.4 inches (1107 x 29.9 x 671 mm)_without stand	
Weight	43.43 lbs (19.7kg)_with stand 34.61 lbs (15.7kg)_without stand	
TV System	Tuning	Frequency Synthesize (Refer to detailed Frequency Table)
	System	DVB-T/C, PAL, SECAM, NT4.43
	Sound	BG, DK, L/L', NICAM, MPEG1, DD, DD+, HE-AAC
Environmental Considerations	Operating Temperature : 32°F ~ 122°F (0°C ~ 50°C) Operating Humidity : 10% ~ 90%, non-condensing Storage temperature : -4°F ~ 140°F (-20°C ~ 60°C) Storage Humidity : 10% ~ 90%	
Audio Spec.	<ul style="list-style-type: none"> <li>- MAX Internal Audio Output Power : Each 10W(Left/Right)</li> <li>- BASS Control Range : -8 dB ~ + 8dB</li> <li>- TREBLE Control Range : -8 dB ~ +8 dB</li> <li>- Headphone Out : 10 mW MAX</li> <li>- Output Frequency : RF : 80 Hz ~ 15 kHz AV/Componet/HDMI : 80 Hz ~ 20 kHz</li> </ul>	
<b>Note:</b> DLNA, Dolby Digital+, Game Mode, Film Mode, Energy Saving, Anynet+		

Model	UE32C4000P	
<b>Feature</b>		
<ul style="list-style-type: none"> <li>▶ DTV/ATV, 4-HDMI, 1-Component, 1-A/V, D-SUB, 1-SCART, 2-USB2.0, CI Slot</li> <li>▶ Brightness : 400 cd/m<sup>2</sup></li> <li>▶ High Contrast Ratio : 40,000:1</li> <li>▶ Response Time : 4.5ms</li> </ul>		
<b>Specifications</b>		
Item	Description	
LCD Panel	32inch HD 60Hz	
Scanning Frequency	Horizontal : 30 kHz ~ 80 kHz (Automatic) Vertical : 47 Hz ~ 75 Hz (Automatic)	
Display Colors	16.7M color	
Maximum resolution	Horizontal : 1366 Pixels Vertical : 768 pixels	
Input Signal	Analog 0.7 Vp-p ± 5% positive at 75Ω , internally terminated	
Input Sync Signal	H/V Separate, TTL, P. or N.	
Maximum Pixel Clock rate	74.25MHz	
Active Display Horizontal/Vertical	27.47 x 15.44 inches (697.69(H) x 392.26(V) mm)	
AC power voltage & Frequency	AC 100V ~ 240V, 50/60Hz	
Power Consumption	Under 100W (Under 0.3W, Stand by)	
Dimensions Set (W x D x H)	30.5 x 10.0 x 21.6 inchs (774.6 x 255.0 x 549.1 mm)_with stand 30.5 x 1.2 x 19.4 inchs (774.6 x 29.9 x 491.8 mm)_without stand	
Weight	24.9 lbs (11.3kg)_with stand 20.3 lbs (9.2kg)_without stand	
TV System	Tuning	Frequency Synthesize (Refer to detailed Frequency Table)
	System	DVB-T/C, PAL, SECAM, NT4.43
	Sound	BG, DK, L/L', NICAM, MPEG1, DD, DD+, HE-AAC
Environmental Considerations	Operating Temperature : 32°F ~ 122°F (0°C ~ 50°C) Operating Humidity : 10% ~ 90%, non-condensing Storage temperature : -4°F ~ 140°F (-20°C ~ 60°C) Storage Humidity : 10% ~ 90%	
Audio Spec.	<ul style="list-style-type: none"> <li>- MAX Internal Audio Output Power : Each 10W(Left/Right)</li> <li>- BASS Control Range : -8 dB ~ + 8dB</li> <li>- TREBLE Control Range : -8 dB ~ +8 dB</li> <li>- Headphone Out : 10 mW MAX</li> <li>- Output Frequency : RF : 80 Hz ~ 15 kHz AV/Componet/HDMI : 80 Hz ~ 20 kHz</li> </ul>	
<b>Note:</b> Dolby Digital*, Game Mode, Film Mode, Energy Saving, Anynet*		





## 2-2. Detail Factory Option

※ If you replace the main board with new one, please change the factory option as well.  
The options you must change are "Type" and "Front Color".

Model Name		UE32C5100QW	UE37C5100QW	UE40C5100QW	UE46C5100QW	UE32C4000PW
Panel	Vendor	CMO	AUO	CMO	AUO	CMO
	CODE	BN07-00849A	BN07-00880A	BN07-00856A	BN07-00384A	BN07-00848A
SMPS	Vendor	DYREL	DYREL	SEM	DYREL	DYREL
	CODE	BN44-00351B	BN44-00351B	BN44-00353A	BN44-00357B	BN44-00349B
1	Factory Reset	-	-	-	-	-
2	Type	19D6THOC ~ 52L6AFOC/ 32P6UF0E	37P6UF0E	40P6UF0E	46P6UF0E	32P6AH0E
3	Local set	EU/EU_Italy//NORDIG/AD_au/ CIS	EU	EU	EU	EU
4	Model	UC4000/UC5000/UC5100/ UC6000	UC5100	UC5100	UC5100	UC4000
5	TUNER	DRXKSEMCO/ DRXKALPS/.....	DRXKSEMCO	DRXKSEMCO	DRXKSEMCO	DRXKSEMCO
6	DDR	SAMSUNG / Etron	SAMSUNG	SAMSUNG	SAMSUNG	SAMSUNG
7	Light Effect	On/Off	Off	Off	Off	Off
8	Ch Table	SUWON/SESK/SHE/TTSEC/ SDMA/ SERK/SEIN/SAVINA/SIEL/ TSE	SEH	SEH	SEH	SEH
9	Country	...	...	...	...	...
10	Front Color	S-BLK/S-R-BLK/S-C-Gray/...	T-C-BLK	T-C-BLK	T-C-BLK	T-R-BLK

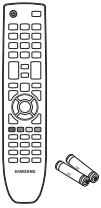
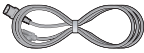
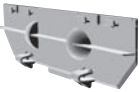
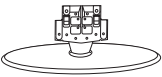
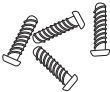
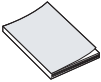
## 2-3. Accessories

Product	Description	Code. No	Remark
	Remote Control & Batteries (AAA x 2)	C5*** : BN59-01015A C4000 : BN59-01014A	Samsung Electronics Service center
	Power Cord	3903-000525	
	Cover-Bottom	32" BN63-06542A 37" BN63-06543A 40" BN63-06543A 46" BN63-06543A 32" BN63-06542B	
	Stand	C5*** 32" BN96-12930B 37" BN96-12931B 40" BN96-12931B 46" BN96-12932B C4000 32" BN96-13157A	
	Screw (for the stand - M4, L6)	6003-000133	
	Owner's Instructions	C5*** : BN68-02656A C4000 : BN68-02655A	
	Warranty Card / Registration Card / Safety Guide Manual (Not available in all locations)		

2. Product specifications

**CHANNEL FREQUENCY TABLE**

1. OUTPUT FREQUENCY : ANALOG fv:45.75MHz, fs:41.25MHz    DIGITAL Fc:44MHz

2. TUNING STEP SIZE    : FIRST PLL 250KHz    SECOND PLL 62.5KHz

OSD	CH NO	AIR		BAND	CH NO	Cable STD	BAND	CH NO	Cable HRC	CH NO	Cable IRC
		Air-DTV	Air-NTSC								
1	1							A-8	72.00	A-8	73.25
2	2	57	55.25	V-L	2	55.25	V-L	2	54.00	2	55.25
3	3	63	61.25	V-L	3	61.25	V-L	3	60.00	3	61.25
4	4	69	67.25	V-L	4	67.25	V-L	4	66.00	4	67.25
5	5	79	77.25	V-L	5	77.25	V-L	A-7	78.00	A-7	79.25
6	6	85	83.25	V-L	6	83.25	V-L	A-6	84.00	A-6	85.25
7	7	177	175.25	V-H	7	175.25	V-H	7	174.00	7	175.25
8	8	183	181.25	V-H	8	181.25	V-H	8	180.00	8	181.25
9	9	189	187.25	V-H	9	187.25	V-H	9	186.00	9	187.25
10	10	195	193.25	V-H	10	193.25	V-H	10	192.00	10	193.25
11	11	201	199.25	V-H	11	199.25	V-H	11	198.00	11	199.25
12	12	207	205.25	V-H	12	205.25	V-H	12	204.00	12	205.25
13	13	213	211.25	V-H	13	211.25	V-H	13	210.00	13	211.25
14	14	473	471.25	UHF	A	121.25	MID	A	120.00	A	121.25
15	15	479	477.25	UHF	B	127.25	MID	B	126.00	B	127.25
16	16	485	483.25	UHF	C	133.25	MID	C	132.00	C	133.25
17	17	491	489.25	UHF	D	139.25	MID	D	138.00	D	139.25
18	18	497	495.25	UHF	E	145.25	MID	E	144.00	E	145.25
19	19	503	501.25	UHF	F	151.25	MID	F	150.00	F	151.25
20	20	509	507.25	UHF	G	157.25	MID	G	156.00	G	157.25
21	21	515	513.25	UHF	H	163.25	MID	H	162.00	H	163.25
22	22	521	519.25	UHF	I	169.25	MID	I	168.00	I	169.25
23	23	527	525.25	UHF	J	175.25	SUPER	J	174.00	J	175.25
24	24	533	531.25	UHF	K	181.25	SUPER	K	180.00	K	181.25
25	25	539	537.25	UHF	L	187.25	SUPER	L	186.00	L	187.25
26	26	545	543.25	UHF	M	193.25	SUPER	M	192.00	M	193.25
27	27	551	549.25	UHF	N	199.25	SUPER	N	198.00	N	199.25
28	28	557	555.25	UHF	O	205.25	SUPER	O	204.00	O	205.25
29	29	563	561.25	UHF	P	211.25	SUPER	P	210.00	P	211.25
30	30	569	567.25	UHF	Q	217.25	SUPER	Q	216.00	Q	217.25
31	31	575	573.25	UHF	R	223.25	SUPER	R	222.00	R	223.25
32	32	581	579.25	UHF	S	229.25	SUPER	S	228.00	S	229.25
33	33	587	585.25	UHF	T	235.25	SUPER	T	234.00	T	235.25
34	34	593	591.25	UHF	U	241.25	SUPER	U	240.00	U	241.25
35	35	599	597.25	UHF	V	247.25	SUPER	V	246.00	V	247.25
36	36	605	603.25	UHF	W	253.25	SUPER	W	252.00	W	253.25
37	37	611	609.25	UHF	AA	259.25	HYPER	AA	258.00	AA	259.25
38	38	617	615.25	UHF	BB	265.25	HYPER	BB	264.00	BB	265.25
39	39	623	621.25	UHF	CC	271.25	HYPER	CC	270.00	CC	271.25
40	40	629	627.25	UHF	DD	277.25	HYPER	DD	276.00	DD	277.25
41	41	635	633.25	UHF	EE	283.25	HYPER	EE	282.00	EE	283.25
42	42	641	639.25	UHF	FF	289.25	HYPER	FF	288.00	FF	289.25
43	43	647	645.25	UHF	GG	295.25	HYPER	GG	294.00	GG	295.25
44	44	653	651.25	UHF	HH	301.25	HYPER	HH	300.00	HH	301.25
45	45	659	657.25	UHF	II	307.25	HYPER	II	306.00	II	307.25
46	46	665	663.25	UHF	JJ	313.25	HYPER	JJ	312.00	JJ	313.25
47	47	671	669.25	UHF	KK	319.25	HYPER	KK	318.00	KK	319.25
48	48	677	675.25	UHF	LL	325.25	HYPER	LL	324.00	LL	325.25
49	49	683	681.25	UHF	MM	331.25	HYPER	MM	330.00	MM	331.25
50	50	689	687.25	UHF	NN	337.25	HYPER	NN	336.00	NN	337.25
51	51	695	693.25	UHF	OO	343.25	HYPER	OO	342.00	OO	343.25
52	52	701	699.25	UHF	PP	349.25	HYPER	PP	348.00	PP	349.25
53	53	707	705.25	UHF	QQ	355.25	HYPER	QQ	354.00	QQ	355.25
54	54	713	711.25	UHF	RR	361.25	HYPER	RR	360.00	RR	361.25
55	55	719	717.25	UHF	SS	367.25	HYPER	SS	366.00	SS	367.25
56	56	725	723.25	UHF	TT	373.25	HYPER	TT	372.00	TT	373.25
57	57	731	729.25	UHF	UU	379.25	HYPER	UU	378.00	UU	379.25
58	58	737	735.25	UHF	VV	385.25	HYPER	VV	384.00	VV	385.25
59	59	743	741.25	UHF	WW	391.25	HYPER	WW	390.00	WW	391.25
60	60	749	747.25	UHF	XX	397.25	HYPER	XX	396.00	XX	397.25
61	61	755	753.25	UHF	YY	403.25	HYPER	YY	402.00	YY	403.25
62	62	761	759.25	UHF	ZZ	409.25	HYPER	ZZ	408.00	ZZ	409.25
63	63	767	765.25	UHF	AAA	415.25	HYPER	AAA	414.00	AAA	415.25
64	64	773	771.25	UHF	BBB	421.25	HYPER	BBB	420.00	BBB	421.25
65	65	779	777.25	UHF	CCC	427.25	ULTRA	CCC	426.00	CCC	427.25
66	66	785	783.25	UHF	DDD	433.25	ULTRA	DDD	432.00	DDD	433.25
67	67	791	789.25	UHF	EEE	439.25	ULTRA	EEE	438.00	EEE	439.25
68	68	797	795.25	UHF	FFF	445.25	ULTRA	FFF	444.00	FFF	445.25
69	69	803	801.25	UHF	GGG	451.25	ULTRA	GGG	450.00	GGG	451.25



## 2-4. New Features explanation

### 2-4-1. Connecting Anynet+ Devices

Anynet+ is a function that enables you to control all connected Samsung devices that support Anynet+ with your Samsung TV's remote.

The Anynet+ system can be used only with Samsung devices that have the Anynet+ feature. To be sure your Samsung device has this feature, check if there is an Anynet+ logo on it.

To connect to a TV

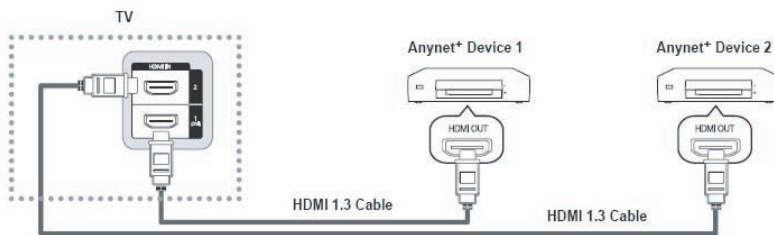

1. Connect the HDMI IN 1(DVI), 2 jack on the TV and the HDMI OUT jack of the corresponding Anynet+ device using an HDMI cable.

To connect to Home Theater

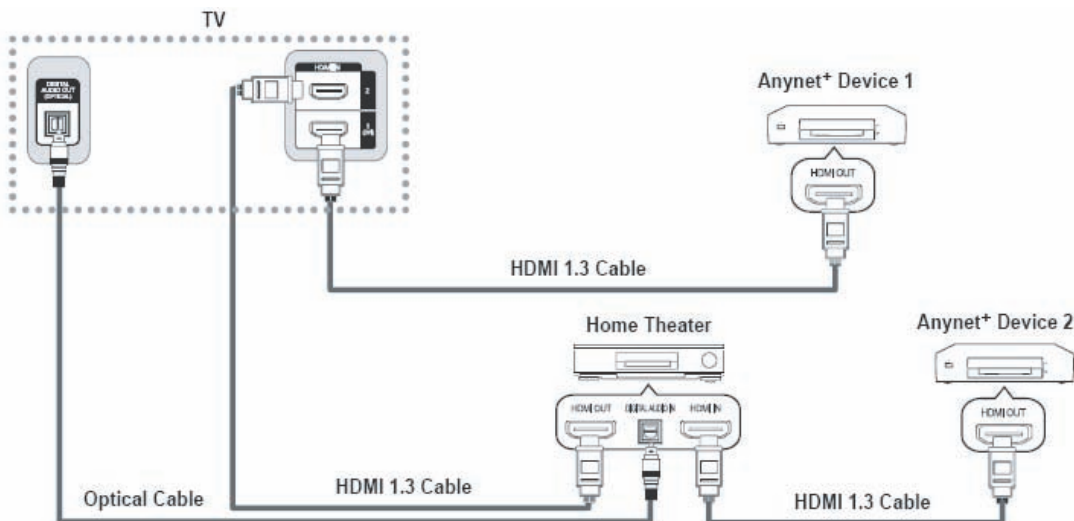

1. Connect the HDMI IN 1(DVI), 2 jack on the TV and the HDMI OUT jack of the corresponding Anynet+ device using an HDMI cable.
2. Connect the HDMI IN jack of the home theater and the HDMI OUT jack of the corresponding Anynet+ device using an HDMI cable.

- Connect the Optical cable between the DIGITAL AUDIO OUT (OPTICAL) jack on your TV and the Digital Audio Input on the Home Theater.
- When following the connection above, the Optical jack only outputs 2 channel audio. You will only hear sound from the Home Theater's Front Left and Right speakers and the subwoofer. If you want to hear 5.1 channel audio, connect the DIGITAL AUDIO OUT (OPTICAL) jack on the DVD / Satellite Box (ie Anynet Device 1 or 2) directly to the Amplifier or Home Theater, not the TV.
- Connect only one Home Theater.
- You can connect an Anynet+ device using the HDMI 1.3 cable. Some HDMI cables may not support Anynet+ functions.
- Anynet+ works when the AV device supporting Anynet+ is in the Standby or On status.
- Anynet+ supports up to 12 AV devices in total. Note that you can connect up to 3 devices of the same type.

## 2-4-2. Media Play

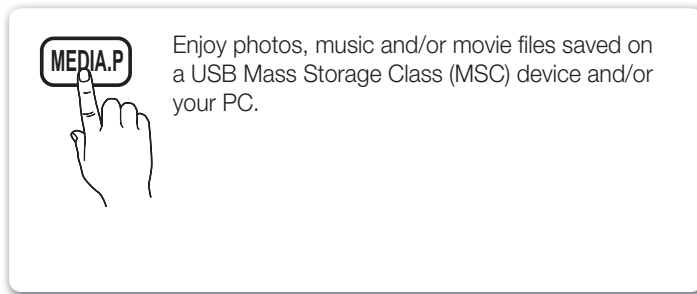

### Connecting a USB Device

1. Turn on your TV.
2. Connect a USB device containing photo, music and/or movie files to the **USB 1 (HDD)** or **USB 2** jack on the side of the TV.
3. When USB is connected to the TV, popup window appears. Then you can select **Media Play**.

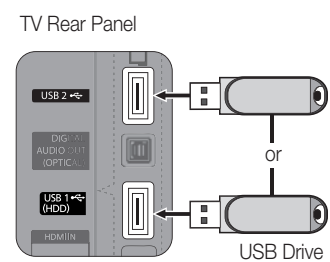

### Connecting to the PC through network

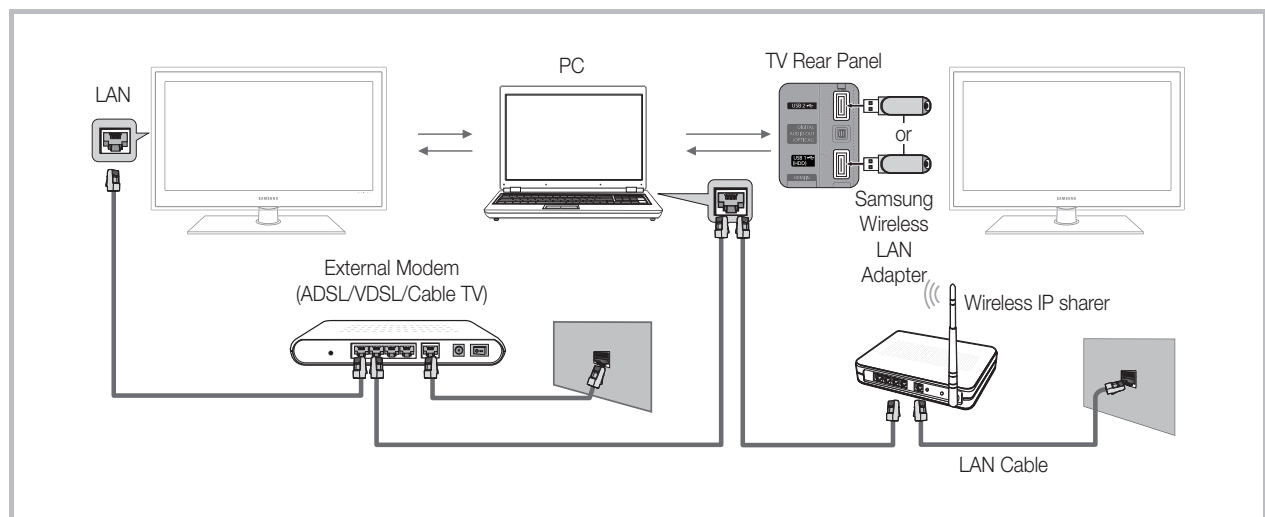

You can play pictures, music and videos saved on your PC through a network connection in the **Media Play** mode.

If you use **Media Play** through saved file on your PC, you should download "PC Share Manager" and users manual from "www.samsung.com."



1. For more information on how to configure your network, refer to "Network Connection."
  - You are recommended to locate both TV and PC in same subnet. The first 3 parts of the subnet address of the TV and the PC IP addresses should be the same and only the last part (the host address) should be changed. (e.g. IP Address: 123.456.789.\*\*)
2. Using a LAN cable, connect between the external modem and the PC onto which the Samsung PC Share Manager programme will be installed.
  - You can connect the TV to the PC directly without connecting it through a Sharer (Router).



 No supported functions when connecting to the PC through network:

- The **Background Music** and **Background Music Setting** functions.
- Sorting files by preference in the **Photos, Music, and Videos** folders.
- The  (REW) or  (FF) button while a movie is playing.

 The Divx DRM, Multi-audio, embedded caption does not supported.

 Samsung PC Share manager should be permitted by the firewall programme on your PC.

 When you use **Media Play** mode through a network connection, According to functions of the provided server:

- The sorting method may vary.
- The scene search function may not be supported.
- The **Play Continuously** function, which resumes playing of a video, may not be supported.
  - The **Play Continuously** function does not support multiple users. (It will have only memorized the point where the most recent user stopped playing.)
- The  or  button may not work depending on the content information.
- If you experience any file stuttering issue while playing a video over a wireless network, we recommend using a wired network.

 It might not work properly with unlicensed multimedia files.

 Need-to-Know List before using **Media Play**

- MTP (Media Transfer Protocol) is not supported.
- The file system supports FAT16, FAT32 and NTFS.
- Certain types of USB Digital camera and audio devices may not be compatible with this TV.
- Media Play only supports USB Mass Storage Class (MSC) devices. MSC is a Mass Storage Class Bulk-Only Transport device. Examples of MSC are Thumb drives, Flash Card Readers and USB HDD (USB HUB are not supported). Devices should be connected directly to the TV's USB port.
- Before connecting your device to the TV, please back up your files to prevent them from damage or loss of data. SAMSUNG is not responsible for any data file damage or data loss.
- Connect a USB HDD to the dedicated port, **USB 1 (HDD)** port.
- Do not disconnect the USB device while it is loading.
- The higher the resolution of the image, the longer it takes to display on the screen.
- The maximum supported JPEG resolution is 15360X8640 pixels.
- For unsupported or corrupted files, the "Not Supported File Format" message is displayed.
- If the files are sorted by Basic View, up to 1000 files can be displayed in each folder.
- MP3 files with DRM that have been downloaded from a non-free site cannot be played. Digital Rights Management (DRM) is a technology that supports the creation of content, the distribution and management of the content in an integrated and comprehensive way, including the protection of the rights and interests of the content providers, the prevention of the illegal copying of contents, as well as managing billings and settlements.
- If more than 2 PTP devices are connected, you can only use one at a time.
- If more than two MSC devices are connected, some of them may not be recognized. A USB device that requires high power (more than 500mA or 5V) may not be supported.
- If an over-power warning message is displayed while you are connecting or using a USB device, the device may not be recognized or may malfunction.
- If the TV has been no input during time set in **Auto Protection Time**, the Screensaver will run.
- The power-saving mode of some external hard disk drives may be released automatically when connected to the TV.
- If a USB extension cable is used, the USB device may not be recognized or the files on the device may not be read.
- If a USB device connected to the TV is not recognized, the list of files on the device is corrupted or a file in the list is not played, connect the USB device to the PC, format the device and check the connection.
- If a file deleted from the PC is still found when Media Play is run, use the "Empty the Recycle Bin" function on the PC to permanently delete the file.

## Screen Display

Move to the file you desired using the up/down/right/left buttons and then press the **ENTER** or **▶** (Play) button. The file is played.

Supports the **View Devices** and **Home in Media Play** homepage.

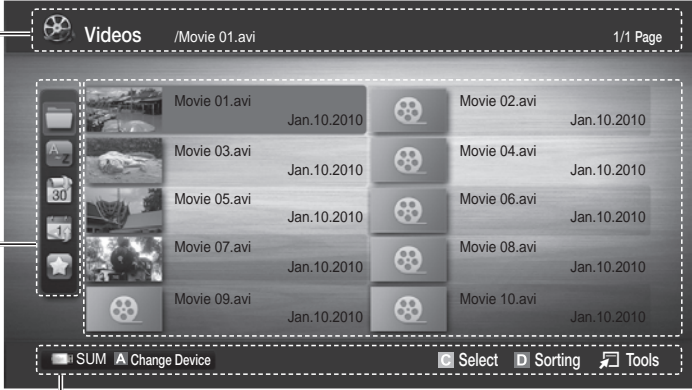

**Information:**  
You can ascertain the selected file name and the number of files and page.

**Sort List Section:**  
Displays sorting standard.

Sorting standard is different depending on the contents.

**File List Section:**  
You can confirm the files and groups that is sorted by each category.

**Operation Buttons**

- Red (Change Device):** Selects a connected device.
- Green (Preference):** Sets the file preference. (not supported in Basic view)
- Yellow (Select):** Selects multiple files from file list. Selected files are marked with a symbol.
- Blue (Sorting):** Selects the sort list.
- Tools:** Displays the option menu.

Using the **◀** (REW) or **▶** (FF) button, file list can move to next or previous page.

## Videos

### Playing Video

1. Press the **◀** or **▶** button to select **Videos**, then press the **ENTER** button in the **Media Play** menu.
2. Press the **◀/▶/▲/▼** button to select the desired file in the file list.
3. Press the **ENTER** button or **▶** (Play) button.
  - The selected file is displayed on the top with its playing time.
  - If video time information is unknown, play time and progress bar are not displayed.
  - During playing the video, you can search using the **◀** and **▶** button.

In this mode, you can enjoy movie clips contained on a Game, but you cannot play the Game itself.

- Supported Subtitle Formats

Name	File extension	Format
MPEG-4 time-based text	.txt	XML
SAMI	.smi	HTML
SubRip	.srt	string-based
SubViewer	.sub	string-based
Micro DVD	.sub or .txt	string-based

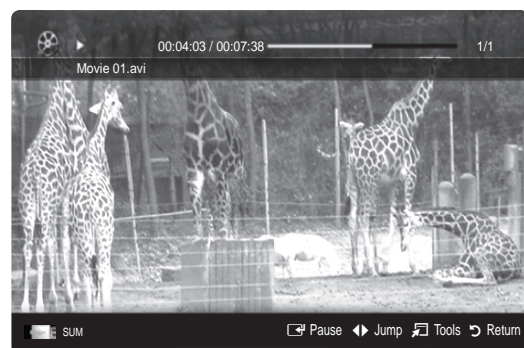



## 2. Product specifications

- Supported Video Formats

File Extension	Container	Video Codec	Resolution	Frame rate (fps)	Bit rate (Mbps)	Audio Codec
*.avi *.mkv	AVI MKV	Divx 3.11 / 4.x / 5.1 / 6.0	1920x1080	6 ~ 30	8	MP3 / AC3 / LPCM / ADPCM / DTS Core
		XviD	1920x1080	6 ~ 30	8	
		H.264 BP / MP / HP	1920x1080	6 ~ 30	25	
		MPEG4 SP / ASP	1920x1080	6 ~ 30	8	
*.asf	ASF	Divx 3.11 / 4.x / 5.1 / 6.0	1920x1080	6 ~ 30	8	MP3 / AC3 / LPCM / ADPCM / WMA
		XviD	1920x1080	6 ~ 30	8	
		H.264 BP / MP / HP	1920x1080	6 ~ 30	25	
		MPEG4 SP / ASP	1920x1080	6 ~ 30	8	
*.wmv	ASF	Window Media Video v9	1920x1080	6 ~ 30	25	WMA
*.mp4	MP4	H.264 BP / MP / HP	1920x1080	6 ~ 30	25	MP3 / ADPCM / AAC
		MPEG4 SP / ASP	1920x1080	6 ~ 30	8	
		XVID	1920x1080	6 ~ 30	8	
*.3gp	3GPP	H.264 BP / MP / HP	1920x1080	6 ~ 30	25	ADPCM / AAC / HE-AAC
		MPEG4 SP / ASP	1920x1080	6 ~ 30	8	
*.vro *.vob	VRO VOB	MPEG1	1920x1080	24 / 25 / 30	30	AC3 / MPEG / LPCM
		MPEG2	1920x1080	24 / 25 / 30	30	
*.mpg *.mpeg	PS	MPEG1	1920x1080	24 / 25 / 30	30	AC3 / MPEG / LPCM / AAC
		MPEG2	1920x1080	24 / 25 / 30	30	
		H.264	1920x1080	6 ~ 30	25	
*.ts *.tp *.trp	TS	MPEG2	1920x1080	24 / 25 / 30	30	AC3 / AAC / MP3 / DD+ / HE-AAC
		H.264	1920x1080	6 ~ 30	25	
		VC1	1920x1080	6 ~ 30	25	

### Other Restrictions

 **NOTE**

- If there are problems with the contents of a codec, the codec will not be supported.
- If the information for a Container is incorrect and the file is in error, the Container will not be able to play correctly.
- Sound or video may not work if the contents have a standard bitrate/frame rate above the compatible Frame/sec listed in the table above.
- If the Index Table is in error, the Seek (Jump) function is not supported.

Video Decoder	Audio Decoder
<ul style="list-style-type: none"> <li>• Supports up to H.264, Level 4.1</li> <li>• H.264 FMO / ASO / RS, VC1 SP / MP / AP L4 and AVCHD are not supported.</li> <li>• GMC is not supported.</li> <li>• H.263 is not supported.</li> </ul>	<ul style="list-style-type: none"> <li>• Supports up to WMA 7, 8, 9, STD</li> <li>• WMA 9 PRO does not support 2 channel excess multi channel or lossless audio.</li> <li>• WMA sampling rate 22050Hz mono is not supported.</li> </ul>

### Playing movie file continuously (Resume Play)

If you exit the playing Videos function, it can be played later from the point where it was stopped.

1. Select the movie file you want to play continuously by pressing the ◀ or ▶ button to select it from the file list section.
2. Press the ▶ (Play) / ENTER button.
3. Select **Play Continuously** (Resume Play) by pressing the Blue button. The Movie will begin to play from where it was stopped.
  - ✎ The Blue button is available when resuming play.
  - ✎ If the **Cont. movie play help** function is set to **On** in the **Settings** menu, a pop-up message will appear when you resume play a movie file.

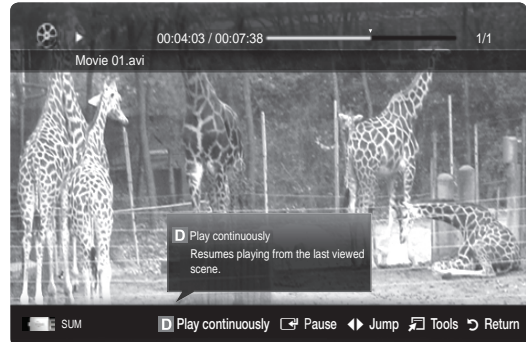

## Music

### Playing Music

1. Press the ◀ or ▶ button to select **Music**, then press the ENTER button in the **Media Play** menu.
  2. Press the ◀/▶/▲/▼ button to select the desired file in the file list.
  3. Press the ENTER button or ▶ (Play) button.
    - During playing the music, you can search using the ◀ and ▶ button.
    - ◀◀ (REW) and ▶▶ (FF) buttons do not function during play.
- ✎ Only displays the files with MP3 and PCM file extension. Other file extensions are not displayed, even if they are saved on the same USB device.
- ✎ If the sound is strange when playing MP3 files, adjust the **Equalizer** in the **Sound** menu. (An over-modulated MP3 file may cause a sound problem.)

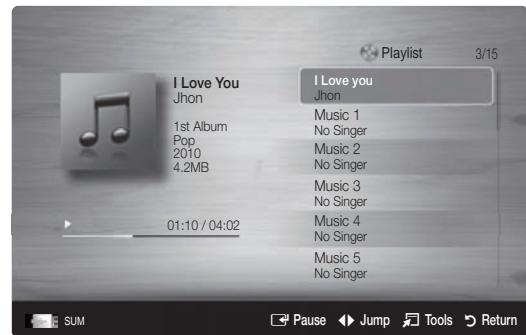

## Photos

### Viewing a Photo (or Slide Show)

1. Press the ◀ or ▶ button to select **Photos**, then press the ENTER button in the **Media Play** menu.
2. Press the ◀/▶/▲/▼ button to select the desired file in the file list.
3. Press the ENTER button or ▶ (Play) button.
  - While a photo list is displayed, press the ▶ (Play) / ENTER button on the remote control to start slide show.
  - All files in the file list section will be displayed in the slide show.
  - During the slide show, files are displayed in order from currently being shown.

✎ Music files can be automatically played during the Slide Show if the **Background Music** is set to **On**.

✎ The **BGM Mode** cannot be changed until the BGM has finished loading.



## Playing the Multiple Files

### Playing the selected video/music/photo files

1. Press the Yellow button in the file list to select the desired file.
2. Repeat the above operation to select multiple files.

 **NOTE**

- The ✓ mark appears to the left of the selected files.
- To cancel a selection, press the Yellow button again.
- To deselect all selected files, press the **TOOLS** button and select **Deselect All**.

3. Press the **TOOLS** button and select **Play Selected Contents**.













### Playing the video/music/photo file group

1. While a file list is displayed, move to the any file in desired group.
2. Press the **TOOLS** button and select **Play Current Group**.

## Media Play Additional Function

### Sorting the file list

Press the Blue button in the file list to sort the files.

Category	Operations	Videos	Music	Photos
 <b>Basic View</b>	It shows whole folder. You can view the photo by selecting the folder.	▼	▼	▼
 <b>Title</b>	It sorts and displays the file title in Symbol/Number/Alphabet/Special order.	▼	▼	▼
 <b>Preference</b>	It sorts and displays the file by preference. You can change the file preference in the file list section using the Green button.	▼	▼	▼
 <b>Latest Date</b>	It sorts and shows files by latest date.	▼		▼
 <b>Earliest Date</b>	It sorts and shows files by earliest date.	▼		▼
 <b>Artist</b>	It sorts the music file by artist in alphabetical.		▼	
 <b>Album</b>	It sorts the music file by album in alphabetical order.		▼	
 <b>Genre</b>	It sorts music files by the genre.		▼	
 <b>Mood</b>	It sorts music files by the mood. You can change the music mood information.		▼	
 <b>Monthly</b>	It sorts and shows photo files by month. It sorts only by month (from January to December) regardless of year.			▼

### Videos/Music/Photos Play Option menu

During playing a file, press the **TOOLS** button.

Category	Operations	Videos	Music	Photos
Title	You can move the other file directly.	▼		
Repeat Mode	You can play movie and music files repeatedly.	▼	▼	
Picture Size	You can adjust the picture size for preference.	▼		
Picture Setting	You can adjust the picture setting. (p. 15, 16, 17)	▼		▼
Sound Setting	You can adjust the sound setting. (p. 17, 18, 19)	▼	▼	▼
Subtitle Setting	You can play the video file with Subtitle. This function only works if the subtitles are the same file name as the video file.	▼		
Audio	You can enjoy video in one of supported languages as required. The function is only enabled when stream-type files which support multiple audio formats are played.	▼		
Stop Slide Show / Start Slide Show	You can start or stop a slide show.			▼
Slide Show Speed	You can select the slide show speed during the slide show.			▼
Slide Show Effect	You can set variously the slide show effect.			▼
Background Music	You can set and select background music when watching a slide show.			▼
Zoom	You can zoom into images in full screen mode.			▼
Rotate	You can rotate images in full screen mode.			▼
Home Background	You can move the file to the <b>Media Play</b> desktop.			▼
Information	You can see detailed information about the played file.	▼	▼	▼

## Settings

### Using the Setup Menu

- **Cont. movie play help (Resume Play) (On / Off):** Select to display the help pop-up message for continuous movie playback.
- **Get the DivX® VOD registration code:** Shows the registration code authorized for the TV. If you connect to the DivX web site and register the registration code with a personal account, you can download VOD registration file. If you play the VOD registration using Media Play, the registration is completed.  
 For more information on DivX® VOD, visit "www.DivX.com."
- **Get the DivX® VOD deactivation code:** When DivX® VOD is not registered, the registration deactivation code is displayed. If you execute this function when DivX® VOD is registered, the current DivX® VOD registration is deactivated.
- **Information:** Select to view information about the connected device.

## 2-4-3. AllShare

### AllShare

#### About AllShare

**AllShare** connects your TV, mobile phones and other devices which are compatible through a network. On your TV, you can view call arrivals, SMS messages and schedules set on your mobile phones. In addition, you can play media contents including videos, photos and music saved on your mobile phones or the other devices (such as your PC) by controlling them on the TV via the network. Additionally, you can use your TV as a monitor for your mobile when browsing a web page.

 For more information, visit “www.samsung.com” or contact the Samsung call centre. Mobile devices may need additional software installation. For details, refer to each device's user's guide.

#### Setting Up AllShare

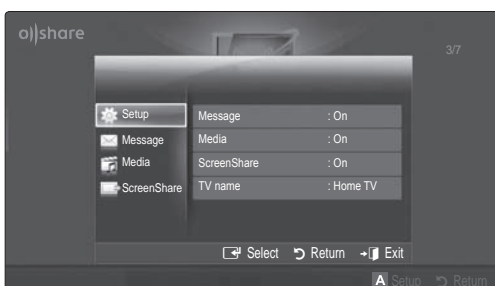

#### Setup

- **Message (On / Off):** Enables or disables the message function (for call arrivals, SMS messages and schedules set on your mobile phones).
  - **Media (On / Off):** Enables or disables the media function. When the media function is on, it plays videos, photos and music from a mobile phone or other device that supports **AllShare**.
  - **ScreenShare (On / Off):** Enables or disables the ScreenShare function for using mobile phone as a remote control.
  - **TV name:** Sets the TV name so you can find it easily on a mobile device.
-  If you select **User Input**, you can type on the TV using the OSK (On Screen Keyboard).



#### Message / Media / ScreenShare

Shows a list of mobile phones or connected devices which have been set up with this TV for using the **Message**, **Media**, or **ScreenShare** function.

-  The **Media** function is available in all mobile devices which support **AllShare**.
- **Allowed / Denied:** Allows/Blocks the mobile phone.
- **Delete:** Deletes the mobile phone from the list.
  -  This function only deletes the name of the mobile from the list. If the deleted mobile device is turned on or tries to connect to the TV, it may appear on the list again.

#### Using the Message Function



Using this function, you view call arrivals, SMS messages and schedules set on the mobile phone through the alarm window while watching TV.

#### NOTE

- To disable the alarm window, set **Message** to **Off** in **Setup** of **AllShare**.
- If **OK** is selected, or if **OK** is not selected after the message has appeared three times, the message will be deleted. The message is not deleted from the mobile phone.
- The alarm window can be displayed while using some applications such as **Media Play** etc. To view the contents of a message, switch to TV viewing mode.
- When a message from an unknown mobile phone is displayed, select the mobile phone on the message menu in **AllShare** and select **Denied** to block the phone.

#### Message View

If a new SMS message arrives while you are watching TV, the alarm window appears. If you click the OK button, the contents of the message are displayed.



-  You can configure the viewing settings for SMS messages on your mobile phones. For the procedures, refer to the mobile phone manual.
-  Some types of characters may be displayed as blank or broken characters.

### Call Arrival Alarm

If a call arrives while you are watching TV, the alarm window appears.

### Schedule Alarm

While you are watching TV, the alarm window appears to display the registered event.

-  You can configure viewing settings for schedule contents on your mobile phones. For the procedures, refer to the mobile phone manual.
-  Some special characters may be displayed as blank or broken characters.

### Using the Media Function

An alarm window appears informing the user that the media contents (videos, photos, music) sent from a mobile phone will be displayed on your TV. The contents are played automatically 3 seconds after the alarm window appears. If you press the **RETURN** or **EXIT** button when the alarm window appears, the media contents are not played.

#### NOTE

- If the media function executes for the first time, the warning popup windows appears. Press the **ENTER**  button to select **Allow**, then you can use Media function on that device.

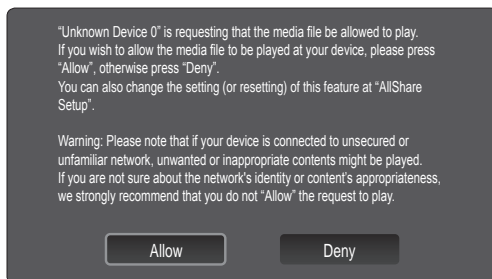

- To turn off the media contents transmission from the mobile phone, set **Media** to **Off** in the **AllShare** setup.
- Contents may not be played on your TV depending on their resolution and format.
- The **ENTER**  and **◀ / ▶** buttons may not work depending on the type of media content.
- Using the mobile device, you can control the media playing. For details, refer to each mobile's user's guide.
- When you want to play media contents from your PC, select the PC icon on the main display of **AllShare**. Then the TV's **Media Play** menu automatically changes. For more detail information, refer to "Media Play" (p. 29).

### Using ScreenShare Function

ScreenShare displays the same web page as provide in mobile. Using ScreenShare, you can open the various contents saved in a mobile phone. For example, the image below displays an access page for contents from a mobile. You can read the mobile's various files and view the phone book and calender on the TV. Also, in phone book, you can make a call to other person, or can send to SMS.

#### NOTE

- In Samsung mobile, ScreenShare must be installed and the supporting application must be executed; then you can use the ScreenShare function.
- Available buttons on your remote control may vary for each page.
- **Doc Viewer** can read files in doc format, but cannot modify them.
- The screen display may differ depending on the connected device.



### Using your Samsung phone to control your TV Simply

Before you can use this feature, you must connect to a Samsung mobile phone that supports ScreenShare functions. When operating the TV with your mobile phone, only the **POWER**, **-**  **+**, **P**  **^**/**∨** and **MUTE** buttons are supported.

-  Even if you keep pressing down on a control button (channel or volume) on the mobile phone, the value will only go up or down by one unit.

## 5. Exploded View & Part List

### 5-1. UE32C5100QW Exploded View

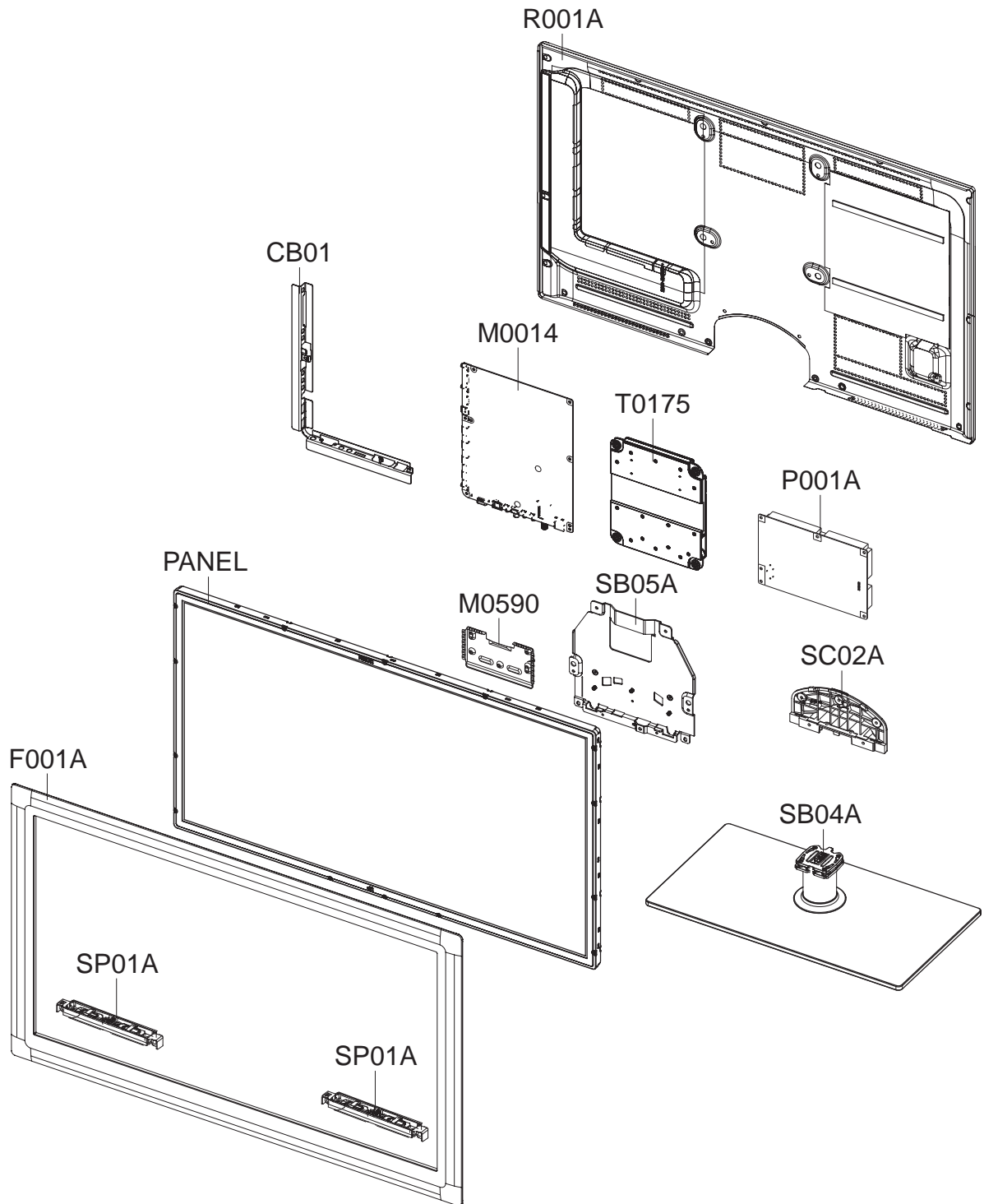

## 5-2. UE32C5100QW Parts List

Location No.	Code No.	Description & Specification	Q'ty	S.A/S.N.A	Remark
CB01	BN61-04924A	BRACKET-AV;LB700 40,PCM,T0.5,BKN-P824, P	1	SNA	
SP01A	BN96-12941E	ASSY SPEAKER P;8ohm,4pin,10,L:270 R:490,	1	SA	
R001A	BN96-12912J	ASSY COVER P-REAR;UC6000 32,EUROPE,PCM,C	1	SA	
M0014	BN94-03368A	ASSY PCB MAIN;UE32C5100QFXXC	1	SA	
T0175	BN96-12944A	ASSY SPEAKER P;4ohm,4pin,10W,R:170,Enclo	1	SA	
P001A	BN44-00351B	DC VSS-LED TV PD BD;PD37AF0E_ZDY,PD37AF0	1	SA	
PANEL	BN07-00849A	LCD-PANEL;T320FAE1-DB,CLL4BC1,8bits,32,1	1	SA	
PANEL	BN07-00849A	LCD-PANEL;T320FAE1-DB,CLL4BC1,8bits,32,1	1	SA	
SB05A	BN96-12927B	ASSY BRACKET P-STAND LINK;UC4000 32,SECC	1	SNA	
SC02A	BN96-13392E	ASSY COVER P-GUIDE STAND;UC4000,PC+ABS G	1	SA	
F001A	BN96-12885B	ASSY COVER P-FRONT;UC5100 32,PC(CLR)+PC(	1	SA	
SB04A	BN96-12761B	ASSY STAND P-BASE;32,EXPORT,TEMPERED GLA	1	SA	



## 5-2-1. UE32C5100QW Parts List

Service Bom (SA: SERVICE AVAILABLE, SNA: SERVICE NOT AVAILABLE)

Level	Location No.	Code No.	Description & Specification	Q'ty	SA/SNA	Remark
0.1		BN90-02528C	ASSY COVER FRONT;UC5000 32	1	SNA	
..2	F001A	BN96-12885B	ASSY COVER P-FRONT;UC5100 32,PC(CLR)+PC(	1	SA	
...3	AB326	BN61-04661A	BRACKET-STOPPER;L650,SK-5,T0.4,Plating,H	2	SNA	
...3		BN61-06213A	BRACKET-STOPPER BOSS;C8K,SECC+SK5,T1.2	8	SNA	
...3		BN61-06215A	BRACKET-STOPPER PANEL;C8K,SK5,0.5T	1	SNA	
...3	CCM1	BN63-05199B	COVER-SHEET;AMBER,PE,T0.08,W65mm,200M,CL	2.4	SNA	
...3	F001	BN63-06603B	COVER-FRONT;UC5100 32,PC(CLR)+PC(Charcoa	1	SNA	
...4		0103-007268	RESIN-PC;TP0010,2.0V0,NH PC,NH PC 2.0 V2	600	SNA	
...4		0103-007269	RESIN-PC;GY0132,2.0V0,NH PC,NH PC 2.0 V2	480	SNA	
...3		BN96-13390A	ASSY HOLDER P-BOSS;UC4000 32,ABS,HB	1	SNA	
...4		BN61-04692A	BOSS-PRIMER,#94,clear,35cps	0.5	SNA	
...4		BN61-05915A	BOSS-TAPE;LB650 65",T1.1,W12.0mm,DARK GR	0.27	SNA	
...4		BN61-05915B	BOSS-TAPE;LB650 65",3M #4711,T1.1,W6.0mm	0.03	SNA	
...4		BN61-06236A	HOLDER-BOSS BOTTOM;UC6100 32inch,ABS,HB	1	SNA	
....5		0103-004609	RESIN-ABS;BK0007,HB,ABS,High Flow ABS	200	SNA	
...3	T0382	BP61-00495C	HOLDER-CARE;PJT,ACRYL-FOAM,T0.25,W30.0mm	0.17	SNA	
...3	M0125	BN96-13047B	ASSY BOARD P-TOUCH FUNCTION&IR;UC5000,CT	1	SA	
...3		BN68-02700A	LABEL-LED-POP;Highlight Sticker Color,PE	1	SNA	
...3	SP01A	BN96-12941E	ASSY SPEAKER P;8ohm,4pin,10,L:270 R:490,	1	SA	
...3		BN61-06630A	BOSS-BOND;UC5000,Acrylated, 3276,Clear,A	0.7	SNA	
...3	CIS1	0203-001598	TAPE-FILAMENT;#8915,0.15,12,55000,CLR	0.06	SNA	
...3		BN60-00162Y	SPACER-FOAM;FOAM,50000mm,Dark Gray,0.35T	1.98	SA	
0.1	R001A	BN90-02550C	ASSY COVER REAR;UC5000 32	1	SNA	
..2	R001A	BN96-12912J	ASSY COVER P-REAR;UC6000 32,EUROPE,PCM,C	1	SA	
...3		BN68-02543B	LABEL-TERMINAL BOTTOM;REV.01 UC5000,PET,	1	SNA	
...3		BN68-02544B	LABEL-TERMINAL SIDE;Rev.01 UC5000/6000,E	1	SNA	
...3		BN96-12924A	ASSY MISC P-INSULATOR;UC6500 32,PC,T0.43	1	SNA	
...4	T0278	BN60-00122E	SPACER-SPONGE;UC6500,CR,L200,T2.0,W10	2	SNA	
...4		BN63-06629A	SHEET-INSULATOR SMPS;UC6100 32inch,PC,T0	1	SNA	
...3	R001	BN63-06516D	COVER-REAR;UC6500 32inch,PCM,T0.5,BKN-P8	1	SNA	
...3	T0069	AA63-60131R	SPACER-FELT;21Z57,FELT,325,T0.35,7	1	SNA	
...3		BN60-00162A	SPACER-FOAM;FOAM,50000L,BLK,0.35T,20W	0.73	SNA	
...3		BN60-00162Y	SPACER-FOAM;FOAM,50000mm,Dark Gray,0.35T	0.4	SA	
..2	T0081	6001-002610	SCREW-MACHINE;BH,+,M4,L6,ZPC(BLK),SWRCH1	7	SA	
..2	SCREW	6003-001782	SCREW-TAPTYPE;BH,+,B,M4,L12,ZPC(BLK),SWR	11	SA	
..2	T0382	BP61-00495C	HOLDER-CARE;PJT,ACRYL-FOAM,T0.25,W30.0mm	0.1	SNA	
0.1	S001A	BN90-02557A	ASSY STAND;UC5000 32	1	SNA	
..2	SC02A	BN96-13392E	ASSY COVER P-GUIDE STAND;UC4000,PC+ABS G	1	SA	
...3	T0524	6902-001048	BAG PE;LDPE,T0.05,W160,L300,TRP,4g	1	SNA	
...3	T0920	BN61-06220A	GUIDE-STAND;UC6500 32inch,PC,G/F 20%,V2,	1	SNA	
...4		0103-007285	RESIN-PC;BK0007,2.0 V2,PC/GF20%,Glass fi	300	SNA	
...3	T0527	BN68-00513A	LABEL-E,PASS;ALL MODEL,YUPO(110G),50X15,	1	SNA	
...3		BN96-12031C	ASSY ACCESSORY-SCREW;09 LEDTV,6003-00013	1	SNA	
...4	M0081	6003-000133	SCREW-TAPTYPE;BH,+,-,S,M4,L8,ZPC(BLK),SW	5	SA	
...4		6902-000336	BAG ZIPPER;LDPE,T0.05,W70,L80,TRP,0.500g	1	SNA	
...4		BN68-02215H	MANUAL FLYER-STAND GUIDE;B6000 ~ 8000,SA	1	SNA	
...3		BN96-12031M	ASSY ACCESSORY-SCREW;10 LEDTV(40/46/55),	1	SNA	
...4	M0081	6003-001003	SCREW-TAPTYPE;BH,+,B,M4,L12,ZPC(BLK),SWR	5	SA	

5. Exploded View & Part List

Level	Location No.	Code No.	Description & Specification	Q'ty	SA/SNA	Remark
...4		BN69-04419K	PACKING-BAG PE;UC5000,LDPE,70,90,4X12, 5	1	SNA	
...3		BN68-02824B	MANUAL FLYER-01,STAND GUIDE;5 ~ 6 series	1	SNA	
..2	SB04A	BN96-12761B	ASSY STAND P-BASE;32,EXPORT,TEMPERED GLA	1	SA	
...3	M0081	6003-001003	SCREW-TAPTYPE;BH,+ ,B,M4,L12,ZPC(BLK),SWR	3	SA	
...3		BN61-04692A	BOSS-PRIMER,#94,clear,35cps	0.1	SNA	
...3		BN61-04731C	BOSS-TAPE;AMBER,ACRYL,T1.1,W16.0mm,WHITE	0.29	SNA	
...3		BN61-04855A	BRACKET-SWIVEL BOTTOM;B650 40,SECC,T2.0	1	SNA	
...3		BN61-05254A	HOLDER-SWIVEL RING BOTTOM;LB700 40,POM H	1	SNA	
...3		BN61-05653A	BRACKET-STAND BOTTOM;B650 32,SECC,T2.0	1	SNA	
...3		BN61-05826A	BOSS-BOND;#760,Poly urethane,Black	2.4	SNA	
...3	GSN01	BN61-05993A	GUIDE-STAND NECK;32,LC650,PETG,V2,TP0003	1	SNA	
...4		0103-007257	RESIN-PETG;ECOZEN-SE,NP01,TP0003,3.2 V2,	150	SNA	
...4		BN61-06078A	GUIDE-NECK-INSERT;32,LC650,PETG,HB,TP000	1	SNA	
...3	CCM1	BN63-04755A	COVER-SHEET;AMBER,PE,T0.05,W150mm,200M,6	1.1	SNA	
...3		BN63-05530C	COVER-STAND GLASS;32,LB650,GLASS,T8.0,1C	1	SNA	
...3	T0056	BN63-06908A	COVER-DECORATION;LB700 40,ABS+PMMA,HB,H/	1	SNA	
...4		0103-005096	RESIN-ABS;HB,ABS+PMMA	10	SNA	
...3	T0527	BN68-00513A	LABEL-E,PASS;ALL MODEL,YUPO(110G),50X15,	1	SNA	
...3	T0527	BN68-01648B	LABEL WARNING;WW,PET,T0.05,40,25,EXPORT	1	SNA	
...3	M0126	BN73-00215A	RUBBER-FOOT;40LB650,RUBBER,15*25,60,4.0,	4	SNA	
...3	M0126	BN73-00217A	RUBBER-FOOT;LB650,RUBBER,DIA30,7.5,Dark	4	SNA	
...3		BN74-00031A	GREASE;kanto-kasei FL-955,grease,wht	0.4	SNA	
0.1	M0017	BN91-05033A	ASSY CHASSIS;UE32C5100QFXXC	1	SNA	
..2	M0014	BN94-03368A	ASSY PCB MAIN;UE32C5100QFXXC	1	SA	
...3		BN97-04054A	ASSY SMD;UE32C5100QFXXC,BN94-02757A?	1	SNA	
...4		BN97-04023A	ASSY MICOM-MAIN;N82A,2009.11.10,T-TDT5DE	1	SNA	
....5		1107-001818	IC-NAND FLASH;KFG1G16U2C-DIB6,1024Mbit,6	1	SNA	
...4		BN97-04024A	ASSY MICOM-SUB;N82A,2009.11.10,T-TDT5DEU	1	SNA	
....5	IC115	1107-001580	IC-FLASH MEMORY;MX25L4005,4Mbit,512Kx8,S	1	SNA	
...4		0202-001767	SOLDER-CREAM;LST-5710,D20~38,Sn-57Bi-1Ag	2.072	SNA	
...4	DS01A	0401-001056	DIODE-SWITCHING;MMBD4148SE,100V,200mA,SO	22	SA	
...4	D0254	0402-000553	DIODE-SCHOTTKY;SS24/B240,40V,2000mA,DO-2	2	SA	
...4		0403-001164	DIODE-ZENER;MMSZ5232B,5.32-5.88V,500MW,S	1	SA	
...4		0403-001180	DIODE-ZENER;BZX84C6V2,5.8-6.6V,350mW,SOT	1	SA	
...4		0403-001783	DIODE-ZENER;BZB84-C6V2,5.8/6.6V,300mW,SO	17	SNA	
...4	D0254	0404-001404	DIODE-SCHOTTKY;BAT721C,40V,200mA,SOT-23,	1	SA	
...4	T0139	0406-001200	DIODE-TVS;RCLAMP0504F,6/-/V,150W,SC-70	2	SA	
...4	T0139	0406-001271	DIODE-TVS;RCLAMP0524P,6/-/V,150W,SLP251	9	SNA	
...4	SD3	0407-000114	DIODE-SWITCHING;KDS184,80V,100mA,SOT-23,	3	SNA	
...4	KQ1	0501-000279	TR-SMALL SIGNAL;KSA1182-Y,PNP,150mW,SOT-	1	SA	
...4	Q101	0501-000445	TR-SMALL SIGNAL;KTC3875S-Y,NPN,150mW,SOT	12	SA	
...4	CEQ2	0505-000110	FET-SILICON;2N7002,N,60V,115mA,7.5ohm,0.	5	SA	
...4	Q409	0505-000274	FET-SILICON;AO4435L,P,-30V,-11A,0.014ohm	1	SNA	
...4	IC104	0801-002630	IC-CMOS LOGIC;74AHCT1G08,2-INPUT AND GAT	1	SA	
...4	ND51C2	0801-002780	IC-CMOS LOGIC;74LVC1G17,SCHMITT-TRIGGER	1	SA	
...4	IC104	0801-003330	IC-CMOS LOGIC;Octal buffer,DQFN,20P,4.5x	3	SA	
...4	IC104	0802-001012	IC-CMOS LOGIC;74LCX245,TRANSCEIVER,DQFN,	1	SNA	
...4	IC106	1001-001573	IC-VIDEO SWITCH;SiI9287BCNUTR,QFN,72P,10	1	SNA	
...4		1006-001474	IC-LINE DRIVER;DRV604PWP,HPSSOP,28P,9.8x	1	SA	
...4	IC112	1103-000129	IC-EEPROM;24C02,2Kbit,256x8,SOP,8P,5x4mm	2	SA	
...4	IC112	1103-001385	IC-EEPROM;AT24C256,256Kbit,32Kx8,SOP,8P,	1	SA	

## 5. Exploded View &amp; Part List

Level	Location No.	Code No.	Description & Specification	Q'ty	SA/SNA	Remark
...4		1105-002058	IC-DDR2 SDRAM;K4T1G164QE-HCF8,DDR2,1Gbit	2	SA	
...4	T0124	1201-002992	IC-POWER AMP;STA369BWS,PSSO,36P,10.3x7.5	2	SA	
...4	T0087	1203-001815	IC-POSI.FIXED REG.;78M09,TO-252,3P,PLAST	1	SA	
...4	T0087	1203-002835	IC-POSI.FIXED REG.;KIA7805AF,DPAK,3P,6.6	1	SA	
...4	T0087	1203-002898	IC-POSI.FIXED REG.;G950T45R,TO-252,3P,6.	1	SA	
...4		1203-004364	IC-VOL. DETECTOR;RT9818C-42PV,SOT-23,3P,	1	SA	
...4	T0087	1203-005134	IC-POSI.FIXED REG.;RT9167A-33PB,SOT-23-5	1	SNA	
...4		1203-005538	IC-DC/DC CONVERTER;AOZ1021HAIL,SOP,8P,4.	1	SA	
...4		1203-005559	IC-BACKLIGHT DRIVER;MP3302DJ,TSOT23,5P,2	1	SA	
...4		1203-006013	IC-DC/DC CONVERTER;AOZ1031AI,SO-8,8P,4.9	1	SA	
...4		1203-006017	IC-VOL. DETECTOR;RT9824GJ8,TSOT23,8P,2.9	1	SA	
...4	T0087	1203-006135	IC-POSI.FIXED REG.;AP1117D-33-GZ-13-89,T	1	SA	
...4	T0087	1203-006136	IC-POSI.FIXED REG.;AP1117D-18-GZ-13-89,T	1	SA	
...4	IC012	1203-006138	IC-POSI.ADJUST REG.;AP1117DGZ-13-89,TO-2	1	SA	
...4		1203-006288	IC-VOL. DETECTOR;RT9818B-18GV,SOT-23-3,3	1	SA	
...4		1204-003088	IC-DEMODULATOR;DRX39XYK,PQFN,64P,9x9x0.8	1	SA	
...4		1204-003096	IC-VIDEO DECODER;HIDTVPRO-SX,PBGA,580P,P	1	SA	
...4		1205-003201	IC-BUS SWITCH;TC7WB125FK,SSOP,8P,2x2.3mm	2	SA	
...4		1205-003479	IC-SWITCH;TPS2051BDBVR,SOT-23,5P,2.9x1.6	1	SA	
...4		1205-003733	IC-SWITCH;AP2191MPG-13,MSOP-8L-EP,8P,2.9	1	SA	
...4		1205-003735	IC-SWITCH;AP2151WG-7,SOT25,5P,2.9x1.6mm,	1	SA	
...4		1405-001185	VARISTOR;24Vdc,1.6x0.8x0.36mm,TP	1	SA	
...4		1405-001271	VARISTOR;20Vdc,5A,1.0x0.5x0.6mm,TP	23	SA	
...4	PR6	2007-000072	R-CHIP;47ohm,5%,1/10W,TP,1608	6	SNA	
...4	R105	2007-000138	R-CHIP;100ohm,5%,1/16W,TP,1005	34	SA	
...4	AR49	2007-000140	R-CHIP;1Kohm,5%,1/16W,TP,1005	5	SNA	
...4	MR306	2007-000141	R-CHIP;2.2Kohm,5%,1/16W,TP,1005	15	SNA	
...4	R319	2007-000143	R-CHIP;4.7Kohm,5%,1/16W,TP,1005	44	SNA	
...4		2007-000146	R-CHIP;6.8Kohm,5%,1/16W,TP,1005	2	SNA	
...4	R104	2007-000148	R-CHIP;10Kohm,5%,1/16W,TP,1005	54	SA	
...4	R102	2007-000149	R-CHIP;12Kohm,5%,1/16W,TP,1005	6	SA	
...4	HDR2	2007-000151	R-CHIP;15Kohm,5%,1/16W,TP,1005	1	SNA	
...4	MR36	2007-000153	R-CHIP;22Kohm,5%,1/16W,TP,1005	8	SNA	
...4	AR43	2007-000155	R-CHIP;27Kohm,5%,1/16W,TP,1005	2	SNA	
...4	MR13	2007-000157	R-CHIP;47Kohm,5%,1/16W,TP,1005	9	SNA	
...4	R123	2007-000159	R-CHIP;56Kohm,5%,1/16W,TP,1005	3	SNA	
...4	DR39	2007-000162	R-CHIP;100Kohm,5%,1/16W,TP,1005	2	SNA	
...4	MR16	2007-000168	R-CHIP;470Kohm,5%,1/16W,TP,1005	1	SNA	
...4	R509	2007-000170	R-CHIP;1Mohm,5%,1/16W,TP,1005	1	SNA	
...4	R111	2007-000171	R-CHIP;0ohm,5%,1/16W,TP,1005	8	SNA	
...4	HDR17	2007-000172	R-CHIP;10ohm,5%,1/16W,TP,1005	12	SNA	
...4	R338	2007-000173	R-CHIP;22ohm,5%,1/16W,TP,1005	14	SNA	
...4	UR23	2007-000174	R-CHIP;47ohm,5%,1/16W,TP,1005	2	SNA	
...4	MR9	2007-000455	R-CHIP;18Kohm,1%,1/10W,TP,1608	1	SA	
...4	ER13	2007-000669	R-CHIP;2Kohm,1%,1/10W,TP,1608	1	SNA	
...4	R726	2007-000695	R-CHIP;3.3ohm,5%,1/10W,TP,1608	2	SNA	
...4		2007-000755	R-CHIP;330Kohm,1%,1/10W,TP,1608	1	SA	
...4	R124	2007-000775	R-CHIP;33Kohm,5%,1/16W,TP,1005	3	SNA	
...4	HR3	2007-000903	R-CHIP;430ohm,1%,1/10W,TP,1608	1	SNA	
...4	DR37	2007-000932	R-CHIP;470ohm,5%,1/16W,TP,1005	1	SNA	
...4		2007-001285	R-CHIP;5.6ohm,5%,1/16W,TP,1005	4	SA	

5. Exploded View & Part List

Level	Location No.	Code No.	Description & Specification	Q'ty	SA/SNA	Remark
...4	OTR1	2007-001292	R-CHIP;33ohm,5%,1/16W,TP,1005	9	SNA	
...4	DR43	2007-001298	R-CHIP;51ohm,5%,1/16W,TP,1005	1	SNA	
...4	R326	2007-001325	R-CHIP;3.3Kohm,5%,1/16W,TP,1005	11	SNA	
...4		2007-002768	R-CHIP;6.2Kohm,1%,1/10W,TP,1608	1	SA	
...4	MR316	2007-002796	R-CHIP;510ohm,5%,1/16W,TP,1005	1	SA	
...4	PR24	2007-002970	R-CHIP;56ohm,5%,1/16W,TP,1005	2	SA	
...4	TR30	2007-007009	R-CHIP;75ohm,5%,1/16W,TP,1005	14	SA	
...4		2007-007134	R-CHIP;39Kohm,1%,1/16W,TP,1005	1	SA	
...4		2007-007135	R-CHIP;18Kohm,1%,1/16W,TP,1005	1	SNA	
...4	DR4	2007-007142	R-CHIP;10Kohm,1%,1/16W,TP,1005	3	SNA	
...4		2007-007156	R-CHIP;1ohm,5%,1/16W,TP,1005	9	SNA	
...4		2007-007312	R-CHIP;20Kohm,1%,1/16W,TP,1005	2	SA	
...4		2007-007316	R-CHIP;3.3Kohm,1%,1/16W,TP,1005	1	SNA	
...4		2007-007317	R-CHIP;2.2Kohm,1%,1/16W,TP,1005	1	SA	
...4		2007-007318	R-CHIP;1Kohm,1%,1/16W,TP,1005	10	SNA	
...4		2007-007334	R-CHIP;200Kohm,1%,1/16W,TP,1005	4	SNA	
...4		2007-007733	R-CHIP;51ohm,1%,1/10W,TP,1608	2	SA	
...4	MR11	2007-008015	R-CHIP;75ohm,1%,1/16W,TP,1005	14	SNA	
...4		2007-008134	R-CHIP;12.4Kohm,1%,1/16W,TP,1005	1	SC	
...4		2007-008275	R-CHIP;30Kohm,1%,1/16W,TP,1005	1	SNA	
...4		2007-008298	R-CHIP;49.9ohm,1%,1/16W,TP,1005	2	SA	
...4		2007-008563	R-CHIP;270ohm,1%,1/16W,TP,1005	1	SA	
...4		2007-008593	R-CHIP;750ohm,1%,1/16W,TP,1005	1	SA	
...4		2007-008649	R-CHIP;220ohm,1%,1/16W,TP,1005	4	SNA	
...4	ZRN10	2011-001261	R-NETWORK;33ohm,5%,1/16W,L,CHIP,8P,TP,2.	6	SA	
...4	DAR09	2011-001262	R-NETWORK;22ohm,5%,1/16W,L,CHIP,8P,TP,2.	5	SA	
...4		2011-001449	R-NETWORK;22ohm,5%,1/16W,L,4P,TP,1010	8	SA	
...4	DRP9	2011-001474	R-NETWORK;47ohm,5%,1/16W,L,CHIP,8P,TP,2.	1	SA	
...4		2011-001519	R-NETWORK;33OHM,5%,1/16W,L,CHIP,4P,TP,1.	3	SA	
...4		2011-001527	R-NETWORK;4.7Kohm,5%,1/16W,L,CHIP,4P,TP,	7	SNA	
...4		2011-001589	R-NETWORK;0ohm,5%,1/16W,L,CHIP-V,4P,TP,1	16	SNA	
...4	DC30	2203-000138	C-CER,CHIP;1.5nF,10%,50V,X7R,TP,1005,-	2	SNA	
...4	PC43	2203-000233	C-CER,CHIP;0.1nF,5%,50V,C0G,TP,1005	4	SA	
...4	MC302	2203-000425	C-CER,CHIP;.018nF,5%,50V,C0G,TP,1005	4	SA	
...4	C254	2203-000438	C-CER,CHIP;1nF,10%,50V,X7R,TP,1005	15	SA	
...4	AC139	2203-000491	C-CER,CHIP;2.2nF,10%,50V,X7R,1608	2	SA	
...4	V1233	2203-000575	C-CER,CHIP;220nF,10%,25V,X7R,TP,2012	9	SNA	
...4	MC9	2203-000627	C-CER,CHIP;.022nF,5%,50V,C0G,TP,1005	2	SNA	
...4	DC374	2203-000659	C-CER,CHIP;0.27nF,5%,50V,C0G,1608	1	SA	
...4	AD480	2203-000679	C-CER,CHIP;0.027nF,5%,50V,C0G,1005	1	SA	
...4	DC25	2203-000812	C-CER,CHIP;.033nF,5%,50V,C0G,1005	11	SA	
...4	CK40B	2203-000838	C-CER,CHIP;0.39NF,5%,50V,C0G,TP,1608	4	SNA	
...4	KFC6	2203-000872	C-CER,CHIP;0.0030nF,0.25pF,50V,C0G,1608	2	SNA	
...4	HDC5	2203-001072	C-CER,CHIP;0.056nF,5%,50V,NP0,1005	4	SA	
...4	C101	2203-001124	C-CER,CHIP;0.68NF,10%,50V,X7R,TP,1005	2	SA	
...4	DC87	2203-001153	C-CER,CHIP;.068nF,5%,50V,NP0,1005	2	SA	
...4	AD480	2203-001428	C-CER,CHIP;470nF,10%,50V,X7R,TP,2012	2	SNA	
...4	AD480	2203-002285	C-CER,CHIP;10nF,10%,50V,X7R,1005	15	SNA	
...4	AD480	2203-002525	C-CER,CHIP;0.56nF,10%,50V,X7R,TP,1005	6	SNA	
...4	C711	2203-002982	C-CER,CHIP;6.8nF,10%,50V,X7R,1005	1	SA	
...4	AAC1	2203-005249	C-CER,CHIP;100nF,10%,50V,X7R,TP,1608	9	SNA	

## 5. Exploded View &amp; Part List

Level	Location No.	Code No.	Description & Specification	Q'ty	SA/SNA	Remark
...4	AD480	2203-005511	C-CER,CHIP;27nF,10%,10V,X7R,TP,1005	1	SA	
...4	AD480	2203-005968	C-CER,CHIP;4.7NF,10%,50V,X7R,TP,1005	2	SNA	
...4	AD480	2203-006039	C-CER,CHIP;1nF,10%,2000V,X7R,3216	2	SA	
...4	AD480	2203-006126	C-CER,CHIP;47nF,10%,16V,X7R,1005	3	SNA	
...4	C102	2203-006158	C-CER,CHIP;100nF,10%,16V,X7R,1005	136	SNA	
...4	JC10	2203-006324	C-CER,CHIP;2200nF,10%,10V,X5R,1608	2	SA	
...4	AD480	2203-006336	C-CER,CHIP;10000nF,10%,25V,X5R,3216	29	SA	
...4	C125	2203-006361	C-CER,CHIP;10000nF,10%,10V,X5R,TP,2012	44	SC	
...4	HE4	2203-006474	C-CER,CHIP;22000nF,20%,6.3V,X5R,2012	3	SA	
...4	AD480	2203-006841	C-CER,CHIP;1000nF,10%,16V,X5R,1005	26	SNA	
...4	AD480	2203-006841	C-CER,CHIP;1000nF,10%,16V,X5R,1005	5	SNA	
...4	AD480	2203-006992	C-CER,CHIP;0.33nF,5%,50V,C0G,TP,1005	2	SNA	
...4		2601-001056	TRANS-SMD,PULSE;350UH,-,1:1,1:1,12.7X6.7	1	SA	
...4	T0052	2703-000158	INDUCTOR-SMD;1uH,10%,2012	4	SA	
...4	T0052	2703-000296	INDUCTOR-SMD;680nH,10%,1608	1	SA	
...4	VL6	2703-000398	INDUCTOR-SMD;10uH,10%,3225	4	SA	
...4	L1103	2703-000403	INDUCTOR-SMD;22uH,10%,3225	1	SA	
...4	T0052	2703-001239	INDUCTOR-SMD;3.3uH,10%,1608	3	SA	
...4	L607	2703-001254	INDUCTOR-SMD;1.8uH,10%,2012	1	SA	
...4	T0052	2703-002268	INDUCTOR-SMD;8.2nH,5%,1005	4	SNA	
...4	T0052	2703-003149	INDUCTOR-SMD;2.2uH,20%,5050	2	SA	
...4	T0052	2703-003150	INDUCTOR-SMD;4.7uH,20%,5050	4	SNA	
...4	T0052	2703-003790	INDUCTOR-SMD;4.7uH,20%,8080	2	SA	
...4	X202	2801-003326	CRYSTAL-SMD;24MHz,30ppm,28-ABX,20pF,50oh	1	SA	
...4	X202	2801-004004	CRYSTAL-SMD;20.25MHz,20ppm,28-AAN,13pF,2	1	SA	
...4	F103	2901-001506	FILTER-EMI SMD;5V,0.13A,0pF,2x1x0.5mm,TP	2	SA	
...4	T0568	3301-001236	BEAD-SMD;60ohm,1608	5	SNA	
...4	T0568	3301-002039	BEAD-SMD;26ohm,1608,TP	39	SA	
...4	T0568	3301-002039	BEAD-SMD;26ohm,1608,TP	2	SA	
...4		3701-001293	CONNECTOR-HDMI;19P,2R,FEMALE,SMD-A,AU	4	SA	
...4	CN906	3707-001095	CONNECTOR-OPTICAL;SMD-A(Ultra Slim),SPDI	1	SA	
...4	AC510	3708-002797	CONNECTOR-FPC/FFC/PIC;51P,0.50mm,SMD,AU,	1	SA	
...4		3710-002276	SOCKET-INTERFACE;24P,1R,0.5mm,SMD-A,AU,B	1	SA	
...4	CON_US	3711-005616	HEADER-BOARD TO CABLE;BOX,10P,1R,2mm,SMD	1	SNA	
...4	HB01A	3711-007336	HEADER-BOARD TO CABLE;BOX,4P,1R,2.5mm,SM	2	SA	
...4		3722-003044	JACK-USB;4P/1C,NI,BLK,SMD-A,A-TYPE	2	SA	
...4		BN41-01378A	PCB MAIN;SX1 5000 DVB,FR-4,4,1.0,1.2T,19	1	SNA	
...4	T0568	3301-001186	BEAD-SMD;600ohm,3216,2500mA,TP,553ohm/93	1	SNA	
...4	T0596	0904-002554	IC-USC;AU6256-JBF,QFN,28P,5x5mm,12MHz,TP	1	SA	
...4		2007-001317	R-CHIP;910ohm,5%,1/16W,TP,1005	1	SNA	
...4	AD480	2203-006824	C-CER,CHIP;4700nF,10%,10V,X5R,1608	1	SNA	
...4	X202	2801-004775	CRYSTAL-SMD;12MHz,30ppm,16pF,30ohm,TP	1	SNA	
...3		BN97-04098A	ASSY CI PLUS;BN46-00025A,LC5F,SX1 platfo	1	SNA	
...4		BN46-00025A	KEY CODE-CI PLUS;KEY;CI PLUS KEY,TCTC,SE	1	SNA	
...3		0202-001608	SOLDER-WIRE FLUX;LFC7-107,D0.8,99.3Sn/0.	0.25	SNA	
...3		3701-001698	CONNECTOR-DSUB;15P,3ROW,FEMALE,ANGLE,NI	1	SA	
...3		3709-001603	CONNECTOR-CARD SLOT;68P(U/SLIM 60mm) W/L	1	SA	
...3		3711-007302	HEADER-BOARD TO BOARD;BOX,18P,2R,2mm,ANG	1	SA	
...3	JA330	3722-002844	JACK-PHONE;1/7P,NI,LAUREL-GREEN,ANGLE	1	SA	
...3	JA330	3722-002845	JACK-PHONE;1/7P,NI,YELLOW,ANGLE	1	SA	
...3	JA330	3722-002846	JACK-PHONE;1/6,NI,BLACK,ANGLE	2	SNA	

5. Exploded View & Part List

Level	Location No.	Code No.	Description & Specification	Q'ty	SA/SNA	Remark
...3		3722-002849	JACK-MODULAR;8P/8C(ULTRA SLIM),YES,ANGLE	1	SNA	
...3	ET01	BN40-00172A	TUNER;DTOS40CVH081A,DVB-T/C,164CH,38.9MH	1	SA	
...3	T0066	BN62-00042A	HEAT SINK-ES;30*30*5,Ceramic,T1.5,TAPE	1	SNA	
...3	T0066	BP62-00047A	HEAT SINK-ES;DLP,A6063S,T2.5,13,13,TAPE	2	SNA	
...3	CCMM1	BN73-00211B	SILICON/RUBBER;UN46B9000FXZA,SILICON+PO	1	SNA	
...3		BN96-14857A	ASSY BRACKET P-AV;UE5100,EO,PCM,T0.5,BKN	1	SNA	
...4	CB01	BN61-04924A	BRACKET-AV;LB700 40,PCM,T0.5,BKN-P824, P	1	SNA	
...4	M0131	BN63-01251A	GASKET;NB24BS,CONDUCTIVE FABRIC,0.7mm,12	1	SNA	
0.1		BN91-05034A	ASSY SHIELD;UE32C5100QFXXC	1	SNA	
..2	T0081	6001-002283	SCREW-MACHINE;BH,+,M3,L5,ZPC(WHT),SWRCH1	9	SNA	
..2	P001A	BN44-00351B	DC VSS-LED TV PD BD;PD37AF0E_ZDY,PD37AF0	1	SA	
..2	T0175	BN96-12944A	ASSY SPEAKER P;4ohm,4pin,10W,R:170,Encl	1	SA	
..2	T0081	6001-000115	SCREW-MACHINE;BH,+,-,M3,L10,ZPC(WHT),SWR	2	SNA	
..2	M2893	BN39-01267F	LEAD CONNECTOR;LB6T,UL2651#26,18P,350mm,	1	SA	
..2	FL06	BN96-13171P	ASSY CABLE P-FFC;UE32C5100,FFC,0.5mm,331	1	SA	
..2	T0081	6001-002610	SCREW-MACHINE;BH,+,M4,L6,ZPC(BLK),SWRCH1	4	SA	
..2	SCREW	6003-001782	SCREW-TAPTYPE;BH,+,B,M4,L12,ZPC(BLK),SWR	1	SA	
..2	CIS1	0203-001586	TAPE-FILAMENT;#893,0.15,25,55	0.05	SNA	
..2	SB05A	BN96-12927B	ASSY BRACKET P-STAND LINK;UC4000 32,SECC	1	SNA	
...3		BN61-02932G	BRACKET-STOPPER NUT;LED TV,M4,D6,L6.5,BR	3	SNA	
...3		BN61-02932H	BRACKET-STOPPER NUT;LED-TV,M4,D6,L5.0,BL	2	SNA	
...3	M0115	BN61-06163A	BRACKET-STAND LINK;UC6500 32inch,SECC,T2	1	SNA	
...3		BN60-00184A	SPACER-FOAM;FOAM,30000mm,DARK GRAY,1T,30	0.12	SNA	
..2	M0131	BN63-00209A	GASKET;RS24NS,CONDUCTIVE FAB,4mm,10mm,30	3	SNA	
0.1		BN91-05200A	ASSY LCD;BN07-00849A	1	SNA	
..2	PANEL	BN07-00849A	LCD-PANEL;T320FAE1-DB,CLL4BC1,8bits,32,1	1	SA	
...3	M0590	BN81-04458A	A/S-T CON T320FAE1-DB;T320FAE1-DB	1	SA	
0.1		BN92-05577C	ASSY BOX;UC5000 32	1	SNA	
..2		BN69-04859B	BOX-SET;32UC5100-GS,CB,A-01,SW2,YEL,W978	1	SNA	
..2		BH68-00662A	LABEL BOX-00;ALL MODEL,MOJO 90G,60,110,W	1	SNA	
0.1		BN92-05599A	ASSY P/MATERIAL;UC5000 32	1	SNA	
..2	T0214	0203-001595	TAPE-OPP MASKING;OPP-2,0.075,75,800M,CLR	2.26	SNA	
..2	T0524	6902-000358	BAG PE;HDPE/NITRON,T0.015/T0.5,W900,L700	1	SNA	
..2		6902-000604	BAG WRAPPING;LDPE,T0.02,W500,L10000,TRP,	1.5	SNA	
..2	M040	6922-000003	BAND PP;PP,T0.8,W18,L1650M,TRP,DA69-9014	0.49	SNA	
..2		BN69-00257B	PACKING-PAD;PAPER,CB-SW4,1130,820,YEL,28	1	SNA	
..2		BN69-00257F	PACKING-BAG SHEET;-,CB,-,1200,500,-,-,WH	1	SNA	
..2		BN69-03982D	PAD PACKING-EDGE;LB6T,PAPER,8,120,1900,Y	1	SNA	
..2	T0246	BN69-04589A	CUSHION-SET;UC5000 32inch,EPS,M65	1	SNA	
..2		BN69-04822G	PALLET-WOOD;2010 LED 32 PS, GS, US,WOOD,	1	SNA	
..2		BN68-02422B	LABEL-WARNING SHIPPING;ALL MODEL,A/P 100	1	SNA	
..2		6902-000379	BAG AIR;LDPE,T0.2,W1000,L1800,TRP,1260.0	1	SNA	
0.1		BN92-05760A	ASSY LABEL;UE32C5100QFXXC	1	SNA	
..2	T0527	AA68-03752B	LABEL-STICKER;WW,ALL,Art Paper(90g),25,3	1	SNA	
..2	T0527	BP68-00052B	LABEL-00,RATING;CCTV,TETRON PAPER,T0.05,	1	SNA	
0.1	ACCE1	BN92-05762A	ASSY ACCESSORY;UE32C5100QFXXC	1	SNA	
..2		BN96-13188A	ASSY ACCESSORY-MANUA;UE32C5100QFXXC	1	SNA	
...3	T0524	6902-000110	BAG PE;LDPE,T0.05,W250,L400,TRP,28,2,9.2	1	SNA	
...3	T0527	BN68-00513A	LABEL-E,PASS;ALL MODEL,YUPO(110G),50X15,	1	SNA	
...3		BN68-00514E	MANUAL FLYER-05,WARRANTY CARD;comm,Samsu	1	SNA	
...3		BN68-02186A	MANUAL FLYER-TOC GUIDE;COMM,SAMSUNG,11 L	1	SNA	

## 5. Exploded View &amp; Part List

Level	Location No.	Code No.	Description & Specification	Q'ty	SA/SNA	Remark
...3		BN68-02656A	MANUAL USERS;C5100,SAMSUNG,6LANGS,W.EURO	1	SNA	
...3		BN68-02839D	MANUAL FLYER-WARRANTY CARD;comm,Samsung,	1	SNA	
...3		AA68-03242V	MANUAL FLYER-SAFETY GUIDE;comm,Samsung,1	1	SNA	
..2	ACCE2	BN96-13188B	ASSY ACCESSORY-CABEL;UE32C5100QFXXC	1	SNA	
...3	EC11	3903-000525	CBF-POWER CORD;DT,CEE,LP-21L,250V,2.5A,B	1	SA	
...3	T0120	4301-000121	BATTERY-MN;1.5V,R03,10.5x44.5m,HOLDER,7.	2	SNA	
...3	M0114	BN39-01154C	CBF SIGNAL;Chelsea Slim, STEREO Plug to	1	SA	
...3	M0114	BN39-01154F	CBF SIGNAL;UE40B7000WWXXC,24P/20P,30AWG,	1	SA	
...3	M0114	BN39-01154H	CBF SIGNAL;UE40B7000WWXXC,RCA 3PIN,30AWG	1	SA	
...3	REMO2	BN59-01015A	REMOCON;TM1060,SAMSUNG,20PIN SINGLE,49KE	1	SA	
...3		BN61-05596A	HOLDER-WIRE CABLE;LED TV,LDPE,T0.8,L150,	1	SNA	
...3	M9889	BN63-01798B	CLOTH-CLEAN;cloth,180,200,sea blue,ToC	1	SA	
...3	T0527	BN68-00513A	LABEL-E,PASS;ALL MODEL,YUPO(110G),50X15,	1	SNA	
...3	EH03A	BN96-10276B	ASSY HOLDER P-RING;09 LEDTV ALL MODEL,AB	1	SA	
....4		6902-000683	BAG ZIPPER;LDPE,T0.05,W60,L60,TRP,4-PE M	1	SNA	
....4	AH365	BN61-05280A	HOLDER-RING;LB7000 46inch,ABS, HB,gray	4	SNA	
...3	EH02A	BN96-10810A	ASSY HOLDER P;09 LEDTV MODEL,NYRON	1	SA	
....4	BAG	6902-000031	BAG ZIPPER;LDPE,T0.05,W80,L160,TRP,0,0,4	1	SNA	
....4	M0114	BN61-05373A	HOLDER-WIRE;LB7000 46,NYRON	3	SNA	
....4		BN61-05491A	HOLDER-WIRE STAND;UB7000 46inch,NYRON	1	SNA	
...3		BN96-12031D	ASSY ACCESSORY-SCREW;09 LEDTV(40/46/55),	1	SNA	
....4	M0081	6003-000133	SCREW-TAPTYPE;BH,+,-,S,M4,L8,ZPC(BLK),SW	1	SA	
....4		BN69-04419E	PACKING-BAG PE;LB650,LDPE,70,90,6003-000	1	SNA	
...3	T0524	6902-000110	BAG PE;LDPE,T0.05,W250,L400,TRP,28,2,9.2	1	SNA	
...3		BN96-14099A	ASSY ACCESSORY-CLAMP;10 LEDTV(40/46/55),	1	SNA	
....4		AA65-30023A	CLAMPER CORE-CABLE;NYLON-66,BLK	1	SNA	
....4		BN69-04419J	PACKING-BAG PE;UC5000,LDPE,70,90,Power-C	1	SNA	
...3	T0531	BN63-06542B	COVER-BOTTOM;UC4000 32,HIPS,V0,BK0020	1	SA	
....4		0103-004637	RESIN-HIPS;BK0020,V0,HIPS,NoN-Deca,NoN-D	60	SNA	



## 3. Disassembly and Reassembly

This section of the service manual describes the disassembly and reassembly procedures for the UE\*\*C5\*\*\*/UE32C4000PW LED TV.

**⚠ WARNING:** This LED TV contains electrostatically sensitive devices. Use caution when handling these components.



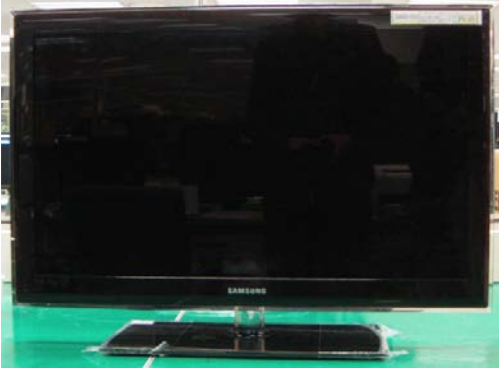
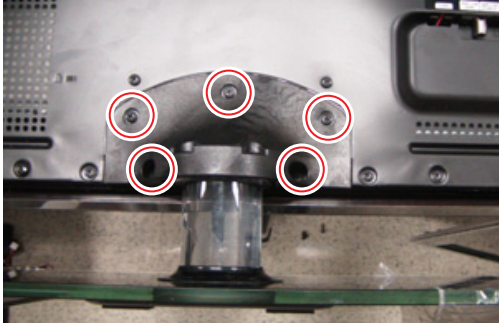
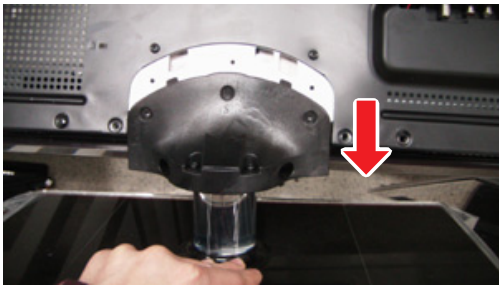

### 3-1. Disassembly and Reassembly





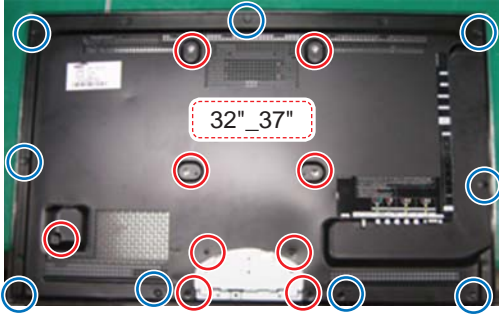
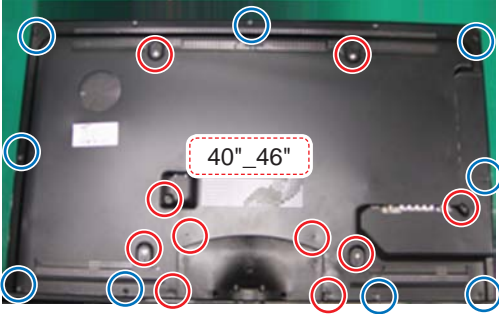

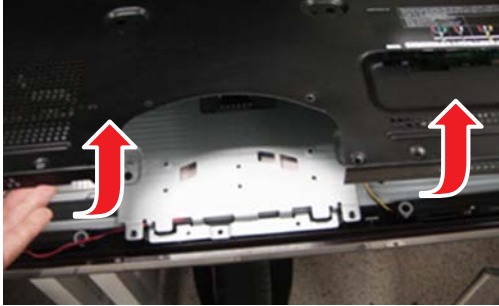
- ⚠ Cautions:**
1. Disconnect the LED TV from the power source before disassembly.
  2. Follow these directions carefully; never use metal instruments to pry apart the cabinet.

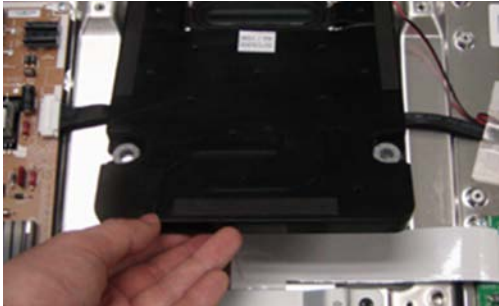
Description	Picture Description	Screws
<p>1. To remove the stand. Place monitor face down on cushioned table. Remove 5 screws from the stand. Remove stand.</p>	  	 <p>6003-000133</p>

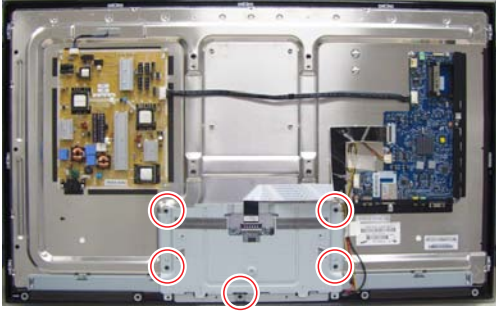

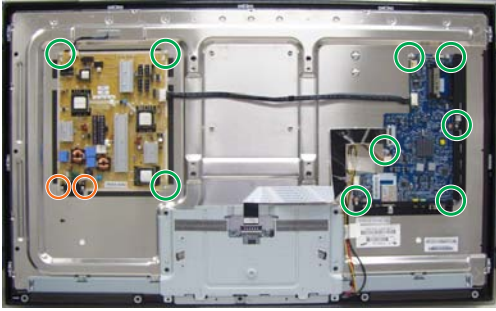
3. Disassembly and Reassembly

Description	Picture Description	Screws
<p>2. <b>32"/37" C5*** :</b> Remove the 18 screws of rear-cover.</p> <p><b>40"/46" C5*** :</b> Remove the 19 screws of rear-cover. Remove the screws of rear-cover.</p>	 	 <p>6003-000133</p>  <p>6003-001003</p>
<p>3. Lift up the rear-cover.</p>		
<p>4. Remove the speaker and Woofer.</p>	 	

Description	Picture Description	Screws
5. Lift up the stand link. Remove the 5 screws of bracket stand link.		 6003-00133
6. Remove the 6 screws of main board and 5 screws of IP board.		 6001-002283  6001-000115
7. Lift up the panel.		

※ Reassembly procedures are in the reverse order of disassembly procedures.

**Screw Size**

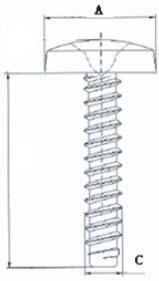
Code No.	A (mm)	B (mm)	C (mm)	Q'ty	
6003-001003	8.3~8.4	12~ 12.4	4~4.15	ALL : 9EA	
6003-000133	8.3~8.4	7.9~8.3	3.70~3.83	32"/37" : 19EA , 40"/46" : 20EA	
6001-002283	6.3~6.5	5.0~5.6	2.87~2.98	ALL : 9EA	
6001-000115	5.8~6.3	9.4~10.0	2.87~2.98	ALL : 2EA	

# 1. Precautions

## 1-1. Safety Precautions

Follow these safety, servicing and ESD precautions to prevent damage and to protect against potential hazards such as electrical shock.

### 1-1-1. Warnings

1. For continued safety, do not attempt to modify the circuit board.
2. Disconnect the AC power and DC power jack before servicing.

### 1-1-2. Servicing the LED TV

1. When servicing the LED TV, Disconnect the AC line cord from the AC outlet.
2. It is essential that service technicians have an accurate voltage meter available at all times. Check the calibration of this meter periodically.

### 1-1-3. Fire and Shock Hazard

Before returning the LED TV to the user, perform the following safety checks:

1. Inspect each lead dress to make certain that the leads are not pinched or that hardware is not lodged between the chassis and other metal parts in the LED TV.
2. Inspect all protective devices such as nonmetallic control knobs, insulating materials, cabinet backs, adjustment and compartment covers or shields, isolation resistor/capacitor networks, mechanical insulators, etc.
3. Leakage Current Hot Check (Figure 1-1):

**WARNING** : Do not use an isolation transformer during this test.

Use a leakage current tester or a metering system that complies with American National Standards Institute (ANSI C101.1, Leakage Current for Appliances), and Underwriters Laboratories (UL Publication UL1410, 59.7).

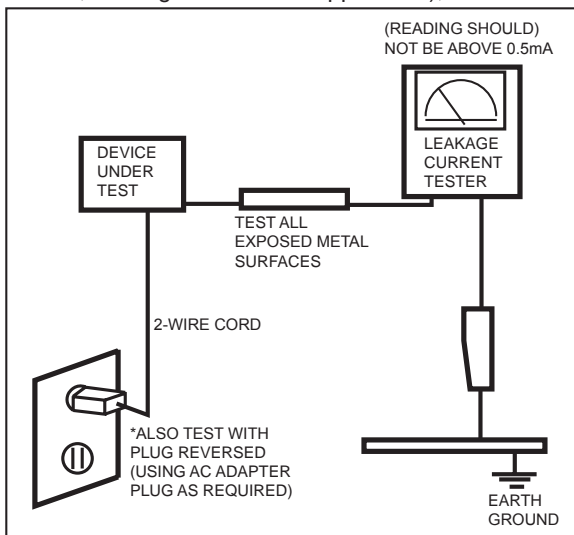

Figure 1-1. Leakage Current Test Circuit

4. With the unit completely reassembled, plug the AC line cord directly into a 120V AC outlet. With the unit's AC switch first in the ON position and then OFF, measure the current between a known earth ground (metal water pipe, conduit, etc.) and all exposed metal parts, including: metal cabinets, screwheads and control shafts. The current measured should not exceed 0.5 milliamp. Reverse the power-plug prongs in the AC outlet and repeat the test.

### 1-1-4. Product Safety Notices

Some electrical and mechanical parts have special safety-related characteristics which are often not evident from visual inspection. The protection they give may not be obtained by replacing them with components rated for higher voltage, wattage, etc. Parts that have special safety characteristics are identified by ⚠ on schematics and parts lists. A substitute replacement that does not have the same safety characteristics as the recommended replacement part might create shock, fire and/or other hazards. Product safety is under review continuously and new instructions are issued whenever appropriate.

## 1-2. Servicing Precautions

**WARNING:** An electrolytic capacitor installed with the wrong polarity might explode.

**Caution:** Before servicing units covered by this service manual, read and follow the Safety Precautions section of this manual.

**Note:** If unforeseen circumstances create conflict between the following servicing precautions and any of the safety precautions, always follow the safety precautions.

### 1-2-1 General Servicing Precautions

1. Always unplug the unit's AC power cord from the AC power source and disconnect the DC Power Jack before attempting to:  
(a) remove or reinstall any component or assembly, (b) disconnect PCB plugs or connectors, (c) connect a test component in parallel with an electrolytic capacitor.
2. Some components are raised above the printed circuit board for safety. An insulation tube or tape is sometimes used. The internal wiring is sometimes clamped to prevent contact with thermally hot components. Reinstall all such elements to their original position.
3. After servicing, always check that the screws, components and wiring have been correctly reinstalled. Make sure that the area around the serviced part has not been damaged.
4. Check the insulation between the blades of the AC plug and accessible conductive parts (examples: metal panels, input terminals and earphone jacks).
5. Insulation Checking Procedure: Disconnect the power cord from the AC source and turn the power switch ON. Connect an insulation resistance meter (500 V) to the blades of the AC plug. The insulation resistance between each blade of the AC plug and accessible conductive parts (see above) should be greater than 1 megohm.
6. Always connect a test instrument's ground lead to the instrument chassis ground before connecting the positive lead; always remove the instrument's ground lead last.

### 1-3. Electrostatically Sensitive Devices (ESD) Precautions

Some semiconductor (solid state) devices can be easily damaged by static electricity. Such components are commonly called Electrostatically Sensitive Devices (ESD). Examples of typical ESD are integrated circuits and some field-effect transistors. The following techniques will reduce the incidence of component damage caused by static electricity.

1. Immediately before handling any semiconductor components or assemblies, drain the electrostatic charge from your body by touching a known earth ground. Alternatively, wear a discharging wrist-strap device. To avoid a shock hazard, be sure to remove the wrist strap before applying power to the LED TV.
2. After removing an ESD-equipped assembly, place it on a conductive surface such as aluminum foil to prevent accumulation of an electrostatic charge.
3. Do not use freon-propelled chemicals. These can generate electrical charges sufficient to damage ESDs.
4. Use only a grounded-tip soldering iron to solder or desolder ESDs.
5. Use only an anti-static solder removal device. Some solder removal devices not classified as "anti-static" can generate electrical charges sufficient to damage ESDs.
6. Do not remove a replacement ESD from its protective package until you are ready to install it. Most replacement ESDs are packaged with leads that are electrically shorted together by conductive foam, aluminum foil or other conductive materials.
7. Immediately before removing the protective material from the leads of a replacement ESD, touch the protective material to the chassis or circuit assembly into which the device will be installed.  
**Caution:** Be sure no power is applied to the chassis or circuit and observe all other safety precautions.
8. Minimize body motions when handling unpackaged replacement ESDs. Motions such as brushing clothes together, or lifting your foot from a carpeted floor can generate enough static electricity to damage an ESD.

---

## 1-4. Installation Precautions

1. For safety reasons, more than a people are required for carrying the product.
2. Keep the power cord away from any heat emitting devices, as a melted covering may cause fire or electric shock.
3. Do not place the product in areas with poor ventilation such as a bookshelf or closet. The increased internal temperature may cause fire.
4. Bend the external antenna cable when connecting it to the product. This is a measure to protect it from being exposed to moisture. Otherwise, it may cause a fire or electric shock.
5. Make sure to turn the power off and unplug the power cord from the outlet before repositioning the product. Also check the antenna cable or the external connectors if they are fully unplugged. Damage to the cord may cause fire or electric shock.
6. Keep the antenna far away from any high-voltage cables and install it firmly. Contact with the highvoltage cable or the antenna falling over may cause fire or electric shock.
7. When installing the product, leave enough space (0.4m) between the product and the wall for ventilation purposes. A rise in temperature within the product may cause fire.

# 6. Wiring Diagram

## 6-1. Wiring Diagram

■ 32"/37"

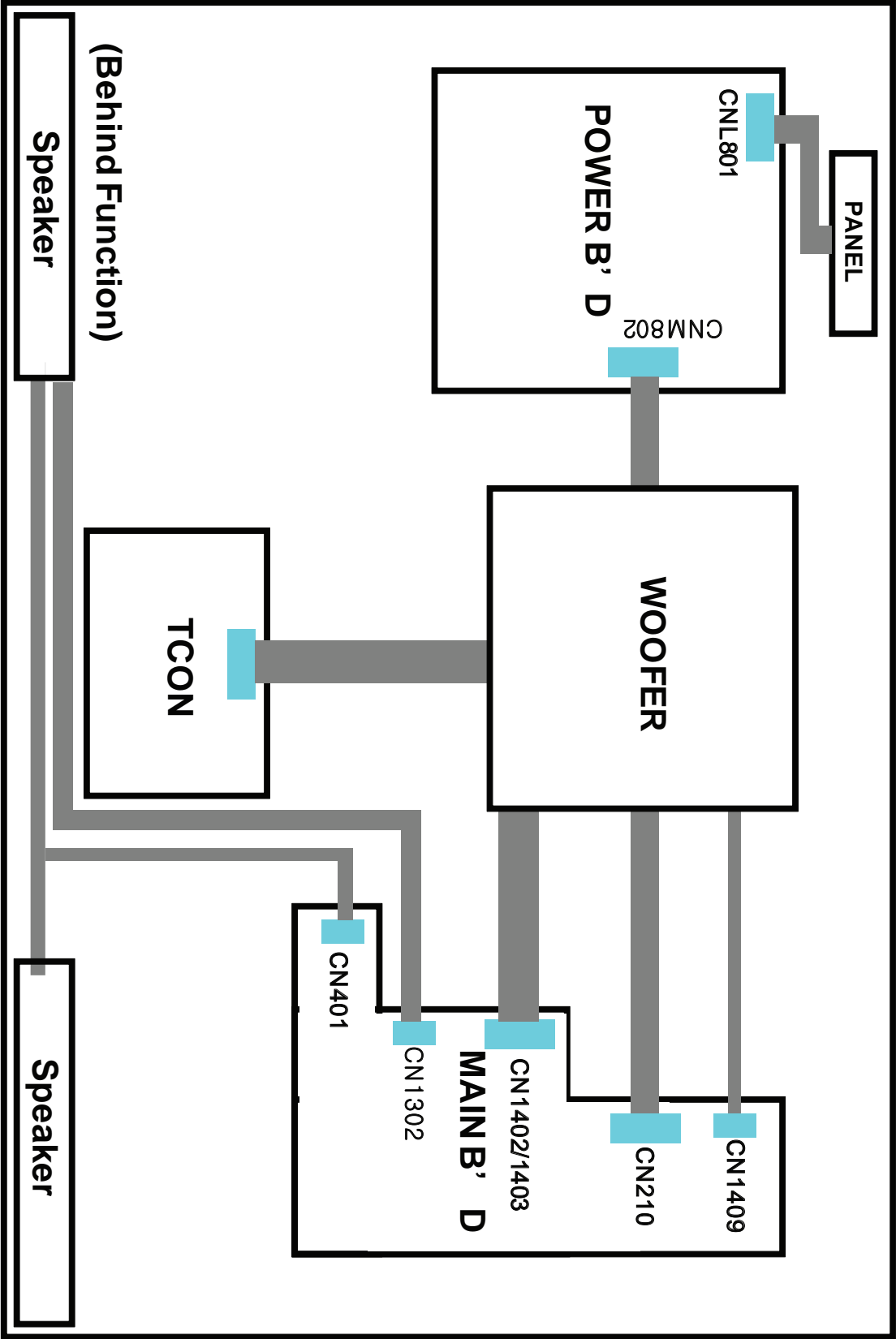



## 6-2. Connector

<b>CN1402_FHD (to Panel) UC5100</b>			
1	NC	27	EVEN[0]-
2	NC	28	GND
3	NC	29	ODD[4]+
4	NC	30	ODD[4]-
5	NC	31	ODD[3]+
6	NC	32	ODD[3]-
7	FORMAT	33	GND
8	SDA_Panel	34	ODDCLK+
9	TCON_WP	35	ODDCLK-
10	NC	36	GND
11	SDA_Panel	37	ODD[2]+
12	SCL_Panel	38	ODD[2]-
13	GND	39	ODD[1]+
14	EVEN[4]+	40	ODD[1]-
15	EVEN[4]-	41	ODD[0]+
16	EVEN[3]+	42	ODD[0]-
17	EVEN[3]-	43	GND
18	GND	44	GND
19	EVENCLK+	45	GND
20	EVENCLK-	46	NC
21	GND	47	Panel_VCC
22	EVEN[2]+	48	Panel_VCC
23	EVEN[2]-	49	Panel_VCC
24	EVEN[1]+	50	Panel_VCC
25	EVEN[1]-	51	Panel_VCC
26	EVEN[0]+		

<b>CN1403_HD (to Panel) UC4000</b>			
1	Panel_VCC	16	ODD[CLK]+
2	Panel_VCC	17	ODD[CLK]-
3	Panel_VCC	18	GND
4	Panel_VCC	19	ODD[2]+
5	Panel_VCC	20	ODD[2]-
6	GND	21	GND
7	GND	22	ODD[1]+
8	GND	23	ODD[1]-
9	TCON_WP	24	GND
10	FORMAT	25	ODD[0]+
11	NC	26	ODD[0]-
12	GND	27	GND
13	ODD[3]+	28	SDA_TCON
14	ODD[3]-	29	SCL_TCON
15	GND	30	NC

<b>CN210 (to Powr board)</b>			
1	B13VS	10	GND
2	SW_POWER	11	GND
3	B13VS	12	H_OUT
4	A5V	13	B13V
5	B5V	14	PWM_DIMMING
6	B5V	15	B13V
7	B5V	16	SW_INVERTER
8	GND	17	B13V
9	GND	18	LAMP_DET

<b>CN401(FUNCTION)</b>			
1	IR	6	KEY_INPUT1
2	GND	7	KEY_INPUT2
3	A3.3V	8	LED_STB
4	MSCL	9	GND
5	MSDA	10	A3.3V

<b>CN1102_LAN(LAN) UC5100</b>			
1	TX+	5	SB2.5V
2	SB2.5V	6	RX-
3	TX-	7	NC
4	RX+	8	GND

<b>CN902(PC)</b>			
1	PC_RED	9	PC_5V
2	PC_GREEN	10	IDENT_PC
3	PC_BLUE	11	R_FANET
4	T_FANET	12	SDA_DOWN
5	GND	13	PC_HS
6	GND	14	PC_VS
7	GND	15	SCL_DOWN
8	GND		

<b>CN901(PC/DIV SOUND)</b>			
1	GND	4	NC
2	PC_SL_IN	5	NC
3	PC_SR_IN	6	NC

<b>CN802(COMPONENT)</b>			
1	GND	6	-
2	COMP1_Y	7	COMP1_PR
3	IDENT_COMP1	8	GND
4	COMP1_PB	9	GND
5	-		



## 6. Wiring Diagram

<b>JA701 (SCART)</b>			
1	GND	13	NC
2	GND	14	SC_G
3	GND	15	GND
4	GND	16	NC
5	SC_CVBS_IN	17	IDENT_SC
6	GND	18	SC_B
7	SC_CVBS_OUT	19	GND
8	GND	20	SC_SL_IN
9	SC_FB	21	SC_SR_IN
10	GND	22	GND
11	SC_R	23	SC_SL_OUT
12	GND	24	SC_SR_OUT

<b>CN1302 (SPEAKER)</b>			
1	R+	3	L+
2	R-	4	L-

<b>CN1409_WF (Woofers)</b>			
1	R+	3	L+
2	R-	4	L-

<b>CN1150_2U(USB2)</b>			
1	USB_VCC	3	USB_DP
2	USB_DM	4	GND

<b>CN1204 (USB1)</b>			
1	USB_VCC	3	USB_DP
2	USB_DM	4	GND

<b>CN801 (AV)</b>			
1	GND	5	NC
2	CVBS	6	NC
3	AV_IDENT	7	SL_IN
4	SR_IN		

<b>CN1002 (HDMI1)</b>			
1	HDMI1_RX2+	11	GND
2	GND	12	HDMI1_RXCLK-
3	HDMI1_RX2-	13	HDMI_CEC
4	HDMI1_RX1+	14	GND
5	GND	15	SCL
6	HDMI1_RX1-	16	SDA
7	HDMI1_RX0+	17	GND
8	GND	18	5V
9	HDMI1_RX0-	19	HPD
10	HDMI1_RXCLK+		

<b>CN1003 (HDMI2)</b>			
1	HDMI2_RX2+	11	GND
2	GND	12	HDMI2_RXCLK-
3	HDMI2_RX2-	13	HDMI_CEC
4	HDMI2_RX1+	14	GND
5	GND	15	SCL
6	HDMI2_RX1-	16	SDA
7	HDMI2_RX0+	17	GND
8	GND	18	5V
9	HDMI2_RX0-	19	HPD
10	HDMI2_RXCLK+		

<b>CN1001 (HDMI3)</b>			
1	HDMI3_RX2+	11	GND
2	GND	12	HDMI3_RXCLK-
3	HDMI3_RX2-	13	HDMI_CEC
4	HDMI3_RX1+	14	GND
5	GND	15	SCL
6	HDMI3_RX1-	16	SDA
7	HDMI3_RX0+	17	GND
8	GND	18	5V
9	HDMI3_RX0-	19	HPD
10	HDMI3_RXCLK+		

<b>CN1004_4AUD (HDMI4)</b>			
1	HDMI4_RX2+	11	GND
2	GND	12	HDMI4_RXCLK-
3	HDMI4_RX2-	13	HDMI_CEC
4	HDMI4_RX1+	14	GND
5	GND	15	SCL
6	HDMI4_RX1-	16	SDA
7	HDMI4_RX0+	17	GND
8	GND	18	5V
9	HDMI4_RX0-	19	HPD
10	HDMI4_RXCLK+		



<b>OP1301 (SPDIF)</b>			
1	SPDIF_OUT	3	GND
2	B5V		

<b>CN1301 (HEADPHONE)</b>			
1	GND	4	GND
2	HP_SL	5	HP_IDENT
3	HP_SR	6	NC

### 6-3. Connector Functions

Connector	Functions
CN210 ↔ IP CNM802	Supply main power and dimming signal from IP board to Main Board.
CN1402_FHD/CN1403_HD ↔ T-CON CNF1	The LVDS signal transferred from Main Board to Panel.

### 6-4. Cables

Use	LEAD (Main-IP 18P)	LVDS (Main - TCON)	
<b>Code</b>	32" C5*** : BN39-01267F (350mm) 37" C5*** : BN39-01267D (450mm) 40" C5*** : BN39-01267C (300mm) 46" C5*** : BN39-01267J(325mm) 32" C4000 : BN39-01267F (350mm)	32" C5*** : BN96-13171P 37" C5*** : BN96-13171Q 40" C5*** : BN96-13171R 46" C5*** : BN96-13171S	32" C4000 : BN96-12469N
<b>Photo</b>			

## **4. Troubleshooting**

---

### **4-1. Troubleshooting**

#### **4-1-1. Previous check**

1. Check the various cable connections first.
  - Check to see if any cables are damaged or burnt.
  - Check to see if there is a disconnected or loose cable connection.
  - Check to see if the cables are connected according to the connection diagram.
2. Check the power input to the Main Board.

### 4-1-2. No Power

Symptom	<ul style="list-style-type: none"> <li>- The LEDs on the front panel do not work when connecting the power cord.</li> <li>- The SMPS relay does not work when connecting the power cord.</li> <li>- The units appears to be dead.</li> </ul>
Major checkpoints	<p>The IP relay or the LEDs on the front panel does not work when connecting the power cord if the cables are improperly connected or the Main Board or SMPS is not functioning. In this case, check the following:</p> <ul style="list-style-type: none"> <li>- Check the internal cable connection status inside the unit.</li> <li>- Check the fuses of each part.</li> <li>- Check the output voltage of SMPS.</li> <li>- Replace the Main Board.</li> </ul>
Diagnostics	<pre> graph TD     Q1[Lamp(Backlight) Off, power indicator LED on?] -- No --&gt; A1[Change 18p power cable.]     Q1 -- Yes --&gt; Q2[Does proper Stand-By DC A5V appear at TP - A5V?]     Q2 -- No --&gt; A2[Change the Main Assy.]     Q2 -- Yes --&gt; Q3[Does proper Main DC B13V, B5V appear at TP - B13V, B5V?]     Q3 -- No --&gt; A2     Q3 -- Yes --&gt; Q4[Does proper DC A3.3V appear at TP - A3.3V?]     Q4 -- No --&gt; A2     Q4 -- Yes --&gt; Q5[Does proper B3.3V, B1.8V, SPI_3.3V appear at BD216 (B3.3V), BD212 (DDR B1.8V) TP - SPI_A3.3V?]     Q5 -- No --&gt; A2     Q5 -- Yes --&gt; Q6[Does proper DC B13V appear at LVDS connector Pin #1~5 of T-con b'd?]     Q6 -- No --&gt; A3[Change the LVDS cable.]     Q6 -- Yes --&gt; Q7[Does proper DC B12V appear at F1 of T-con b'd?]     Q7 -- No --&gt; A4[Change the T-con b'd. (except for 4000 series)]     Q7 -- Yes --&gt; Q8[A power is supplied to set?]     Q8 -- No --&gt; A5[Check a other function. (No picture part) Replace a LCD Panel.]     </pre>
Caution	<p>Make sure to disconnect the power before working on the IP board.</p>

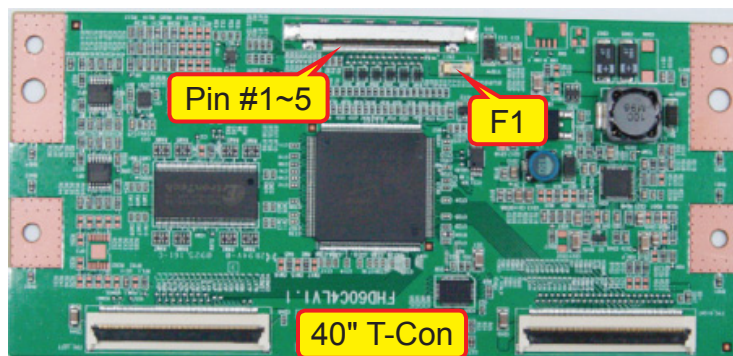
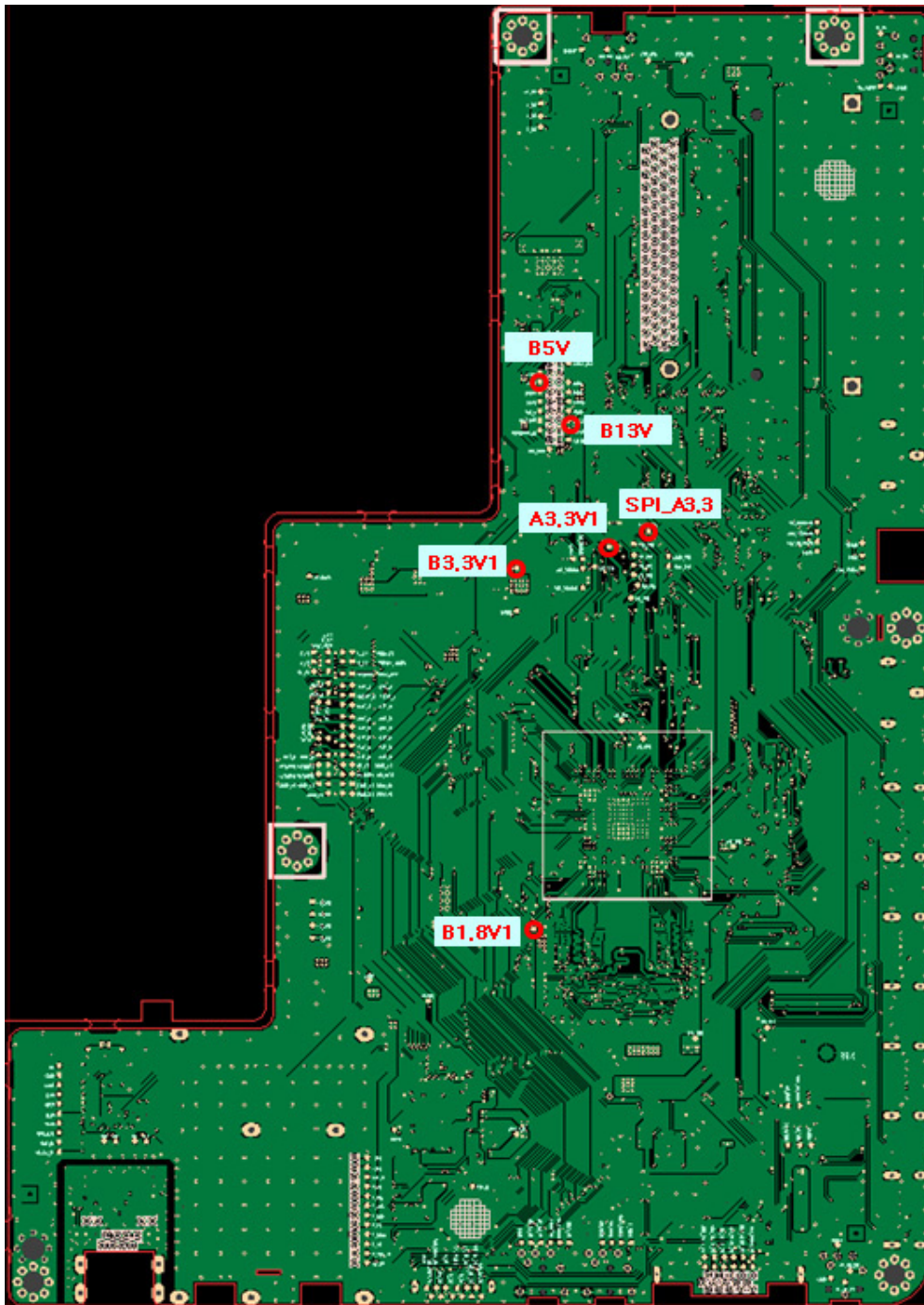

### 4-1-3. No Video (Analog PC signal)

Symptom	<ul style="list-style-type: none"> <li>- Audio is normal but no picture is displayed on the screen.</li> </ul>
Major checkpoints	<ul style="list-style-type: none"> <li>- Check the PC source</li> <li>- Check the Arsenal, Check the Chelsea.</li> <li>- This may happen when the LVDS cable connecting the Main Board and the Panel is disconnected.</li> </ul>
Diagnostics	<pre> graph TD     Q1[Power indicator LED is off. Lamp(Backlight) on, no video?] -- No --&gt; A1[Check a set in the 'Stand-by mode' or 'DPMS mode'.]     Q1 -- Yes --&gt; Q2[Check the PC source and check the connection of D-SUB ?]     Q2 -- No --&gt; A2[Input the analog PC signal properly.]     Q2 -- Yes --&gt; Q3[1 Does the signal appear at TP - PC_R, PC_G, PC_B, PC_HS, PC_VS (R, G, B, H, V) ?]     Q3 -- No --&gt; A3[Check CN902, PC cable. Change the Main Assy.]     Q3 -- Yes --&gt; Q4[2 Does the digital data appear at TP - O_TXCLK+, O_TXCLK-, F_TXCLK+, F_TXCLK- ?]     Q4 -- No --&gt; A4[Check IC1102 (SX1) Change the Main Assy.]     Q4 -- Yes --&gt; Q5[Check the LVDS cable? Check the T-Con B'd? Replace the LCD panel?]     Q5 -- No --&gt; A5[Please, Contact Tech support.]     </pre>
Caution	<p>Make sure to disconnect the power before working on the IP board.</p>

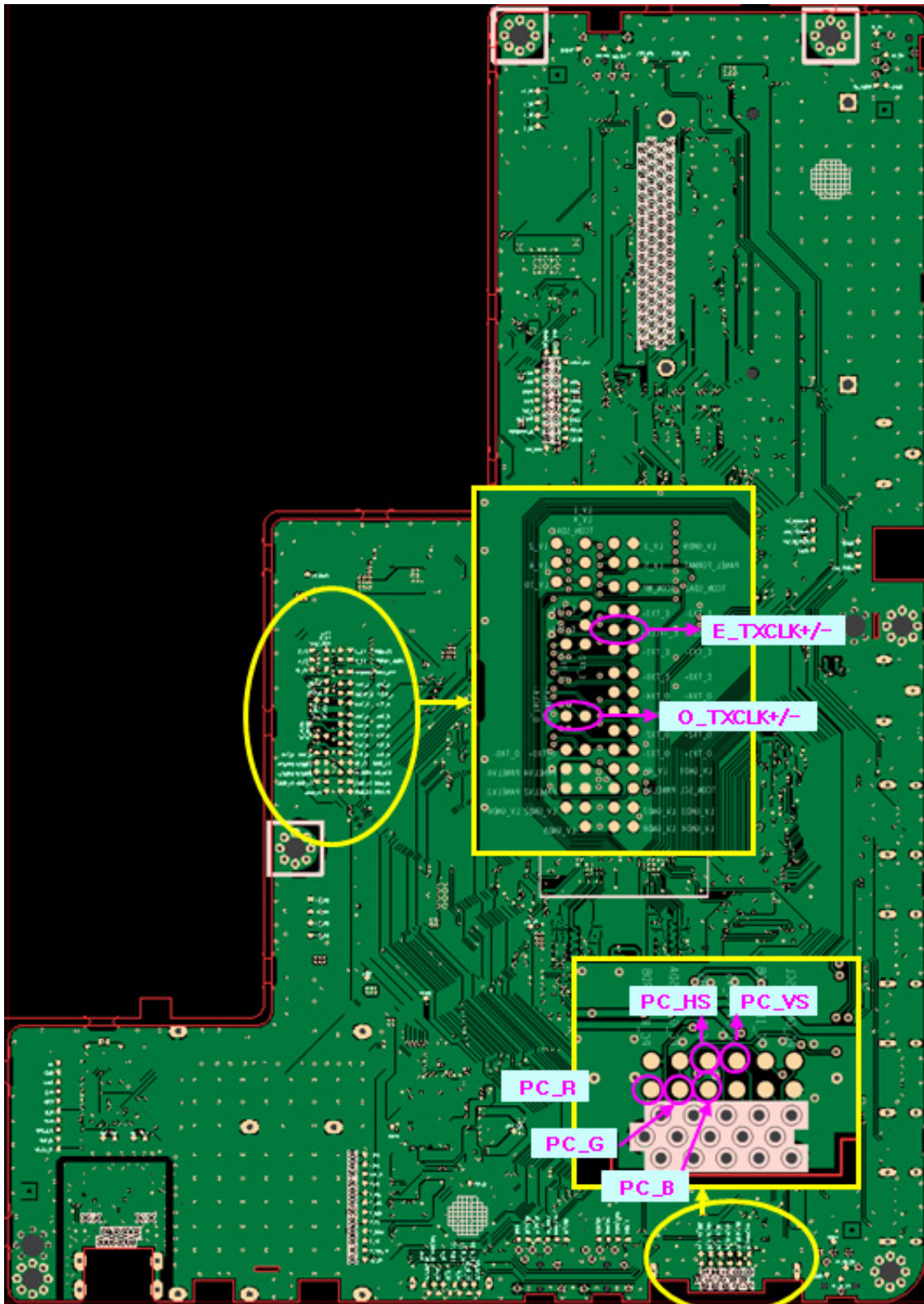

■ WAVEFORMS

1 PC input (V-sink , H-sink , R/G/B)

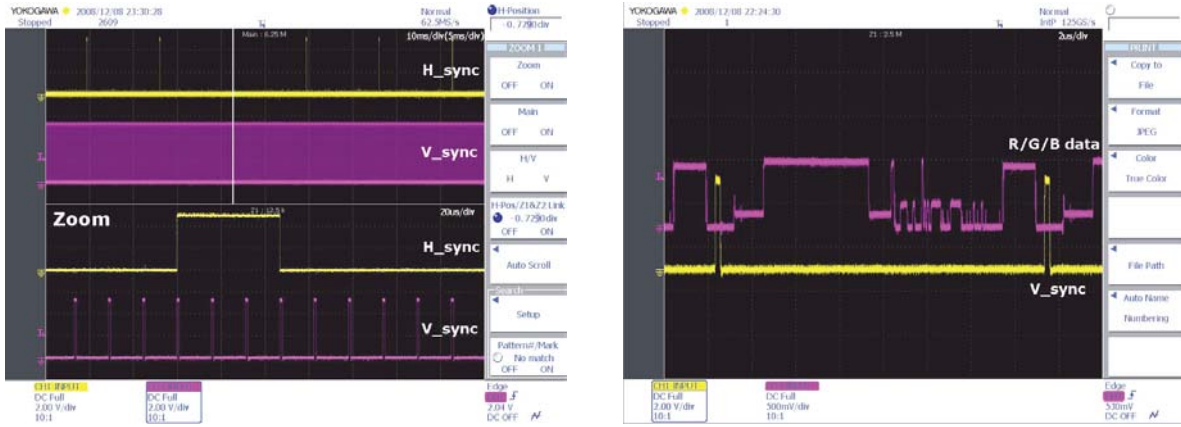

2 LVDS output

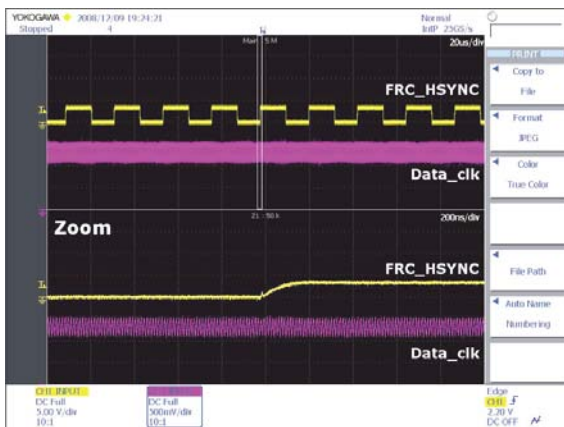



### 4-1-4. No video (HDMI 1, 2, 3, 4 - Digital signal)

Symptom	<ul style="list-style-type: none"> <li>- Audio is normal but no picture is displayed on the screen.</li> </ul>
Major checkpoints	<ul style="list-style-type: none"> <li>- Check the HDMI source.</li> <li>- Check the HDMI switch, Check the SX1.</li> <li>- This may happen when the LVDS cable connecting the Main Board and the Panel is disconnected.</li> </ul>
Diagnostics	<pre> graph TD     Q1[Power indicator LED is off. Lamp(Backlight) on, no video ?] -- No --&gt; A1[Check a set in the 'Stand-by mode']     Q1 -- Yes --&gt; Q2[Check the HDMI source and check the connection of HDMI cable ?]     Q2 -- No --&gt; A2[Input the HDMI signal properly.]     Q2 -- Yes --&gt; Q3[Does the signal appear at CN1002 (Pin#12 , #7 )(HDMI1) CN1003 (Pin#12 , #7 )(HDMI2) CN1001 (Pin#12 , #7 )(HDMI3) CN1004 (Pin#12 , #7 )(HDMI4) (HDMI RX_Clk , RX_Data) ?]     Q3 -- No --&gt; A3[Check CN1001, CN1002. CN1003, CN1004. Check HDMI cable. Change the Main Assy.]     Q3 -- Yes --&gt; Q4[Does the digital data appear at TP - O_TXCLK+, O_TXCLK-, F_TXCLK+, F_TXCLK- ?]     Q4 -- No --&gt; A4[Check IC1102 (SX1) Change the Main Assy.]     Q4 -- Yes --&gt; Q5[Check the LVDS cable? Check the T-Con B'd? Replace the LCD panel?]     Q5 -- No --&gt; A5[Please, Contact Tech support.]     </pre>
Caution	<p>Make sure to disconnect the power before working on the IP board.</p>

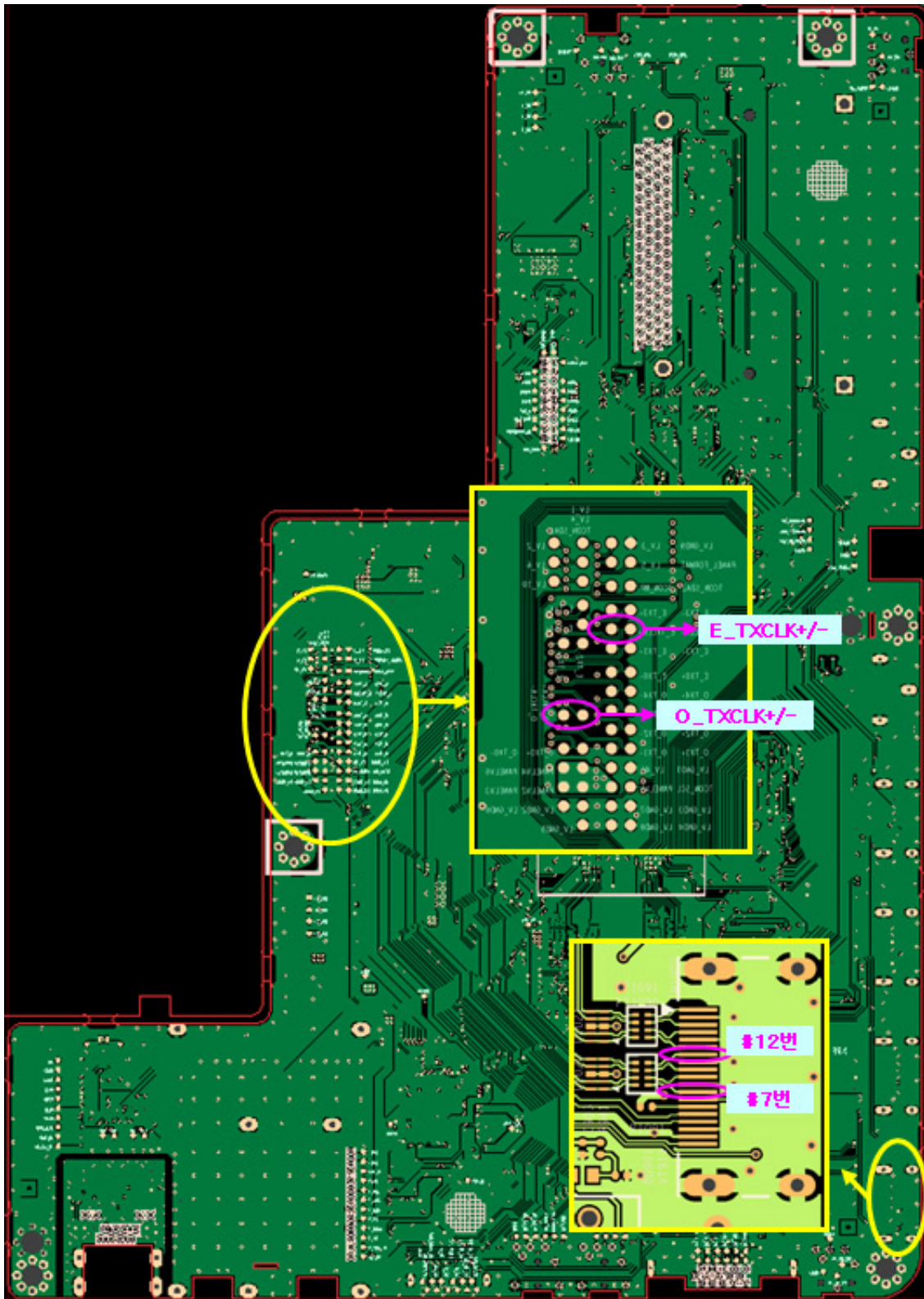

## ■ WAVEFORMS

### 3 HDMI input (RX\_Data, RX\_Clk)

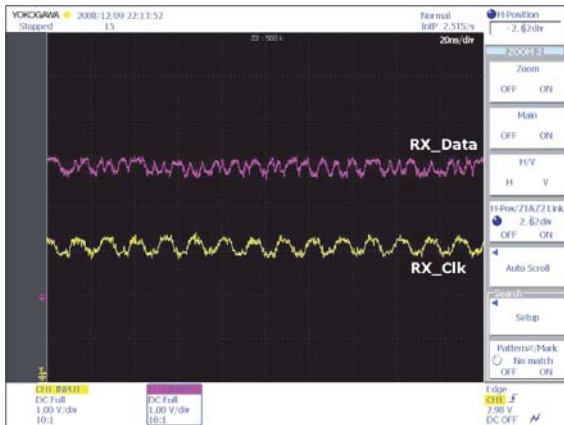

### 2 LVDS output

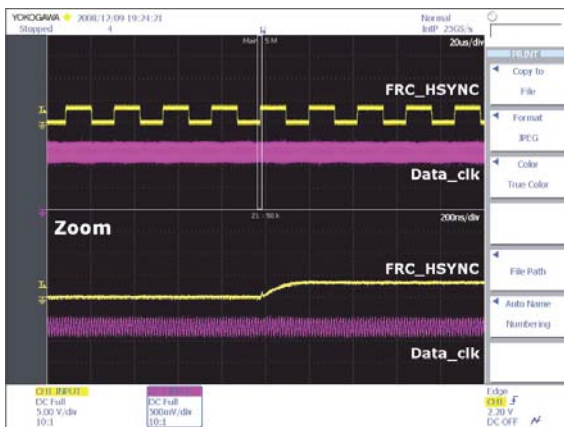

### 4-1-5. No Video (Tuner\_CVBS)

Symptom	<ul style="list-style-type: none"> <li>- Audio is normal but no picture is displayed on the screen.</li> </ul>
Major checkpoints	<ul style="list-style-type: none"> <li>- Check the Tuner CVBS source.</li> <li>- Check the Tuner, Check the SX1.</li> <li>- This may happen when the LVDS cable connecting the Main Board and the Panel is disconnected.</li> </ul>
Diagnostics	<pre> graph TD     Q1[Power indicator LED is off. Lamp(Backlight) on, no video ?] -- No --&gt; A1[Check a set in the 'Stand-by mode']     Q1 -- Yes --&gt; Q2[Check the RF source and check the connection of RF cable ?]     Q2 -- No --&gt; A2[Input the RF source properly.]     Q2 -- Yes --&gt; Q3[Does the DC TU5V_PW, TU33V_PW appear at TP - TUNER_33V, B 5V Pin of Tuner ?]     Q3 -- No --&gt; A3[Change the Main Assy.]     Q3 -- Yes --&gt; Q4[Does the digital data appear at TP - O_TXCLK+, O_TXCLK-, F_TXCLK+, F_TXCLK- ?]     Q4 -- No --&gt; A4[Check IC1102 (SX1). Change the Main Assy.]     Q4 -- Yes --&gt; Q5[Check the LVDS cable? Check the T-Con B'd? Replace the LCD panel?]     Q5 -- No --&gt; A5[Please, Contact Tech support.]     </pre>
Caution	<p>Make sure to disconnect the power before working on the IP board.</p>

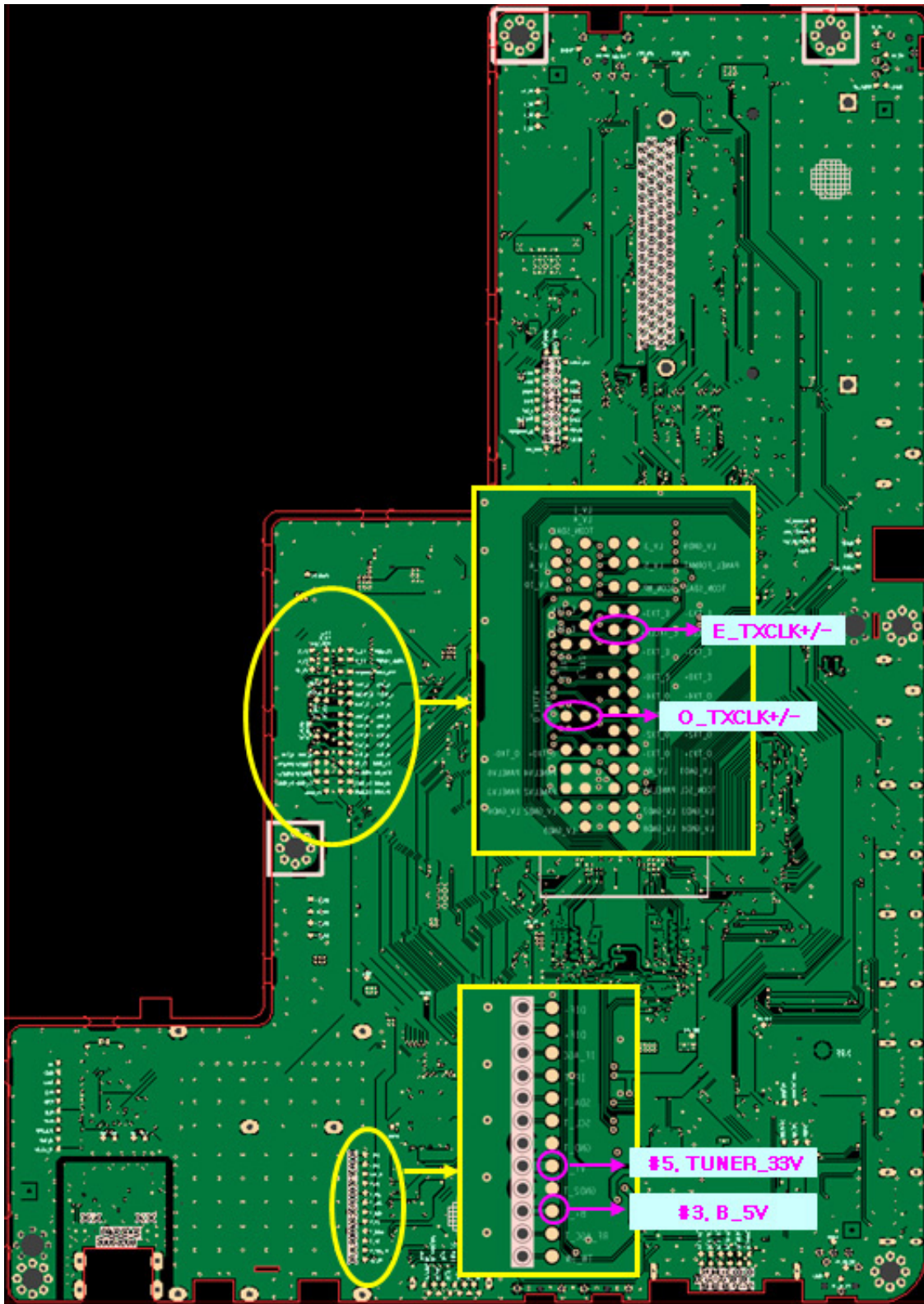

## ■ WAVEFORMS

### ② LVDS output

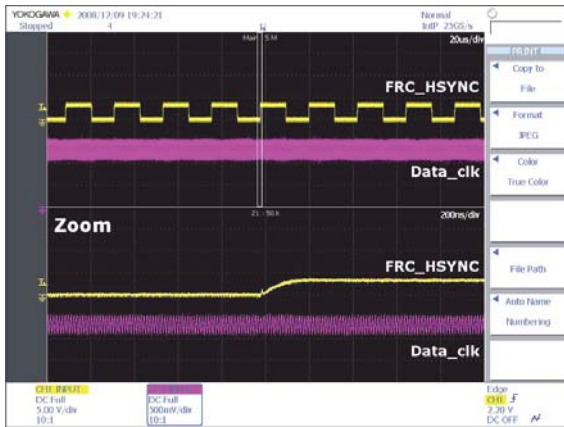

### 4-1-6. No Video (Tuner DTV)

Symptom	<ul style="list-style-type: none"> <li>- Audio is normal but no picture is displayed on the screen.</li> </ul>
Major checkpoints	<ul style="list-style-type: none"> <li>- Check the DTV source.</li> <li>- Check the Tuner, Check the SX1.</li> <li>- This may happen when the LVDS cable connecting the Main Board and the Panel is disconnected.</li> </ul>
Diagnostics	<pre> graph TD     Q1[Power indicator LED is off. Lamp(Backlight) on, no video ?] -- No --&gt; A1[Check a set in the 'Stand-by mode']     Q1 -- Yes --&gt; Q2[Check the RF source and check the connection of RF cable ?]     Q2 -- No --&gt; A2[Input the RF source properly.]     Q2 -- Yes --&gt; Q3[Check the 'signal strength' in Self Diagnosis menu Strength is enough ?]     Q3 -- No --&gt; A3[Check the D-TV source.]     Q3 -- Yes --&gt; Q4[Does the DC TU5V_PW, TU33V_PW appear at TP - TUNER_33V, B 5V Pin of Tuner ?]     Q4 -- No --&gt; A4[Change the Main Assy.]     Q4 -- Yes --&gt; Q5[Does the digital data appear at TP - O_TXCLK+, O_TXCLK-, F_TXCLK+, F_TXCLK- ?]     Q5 -- No --&gt; A5[Check IC1102 (SX1). Change the Main Assy.]     Q5 -- Yes --&gt; Q6[Check the LVDS cable? Check the T-Con B'd? Replace the LCD panel?]     Q6 -- No --&gt; A6[Please, Contact Tech support.]   </pre>
Caution	Make sure to disconnect the power before working on the IP board.

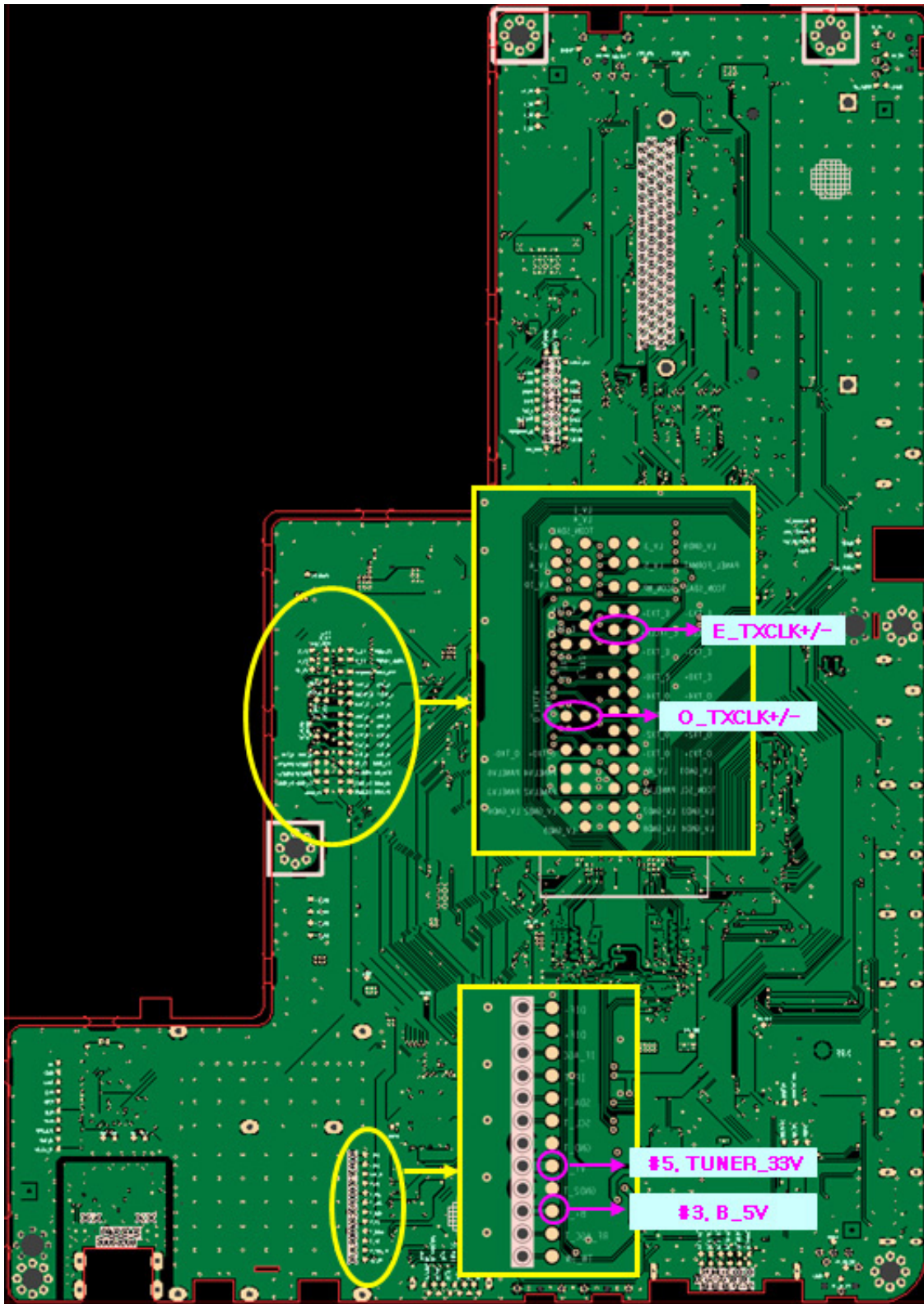



## ■ WAVEFORMS

**2**

LVDS output

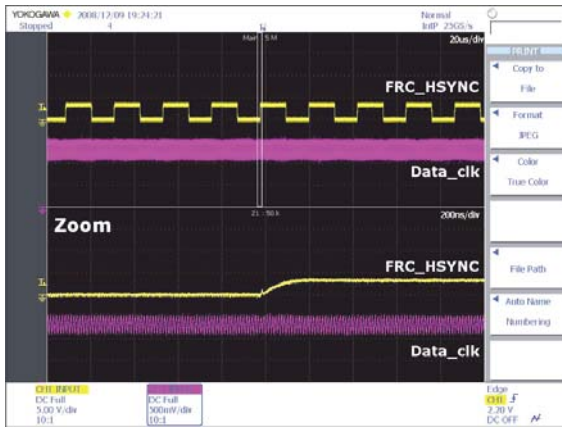

### 4-1-7. No Video (Video CVBS)

Symptom	<ul style="list-style-type: none"> <li>- Audio is normal but no picture is displayed on the screen.</li> </ul>
Major checkpoints	<ul style="list-style-type: none"> <li>- Check the Video CVBS source</li> <li>- Check the SX1.</li> <li>- This may happen when the LVDS cable connecting the Main Board and the Panel is disconnected.</li> </ul>
Diagnostics	<pre> graph TD     Q1[Power indicator LED is off. Lamp(Backlight) on, no video ?] -- No --&gt; A1[Check a set in the 'Stand-by mode'.]     Q1 -- Yes --&gt; Q2[Check the video source and check the connection of video cable?]     Q2 -- No --&gt; A2[Input the video source properly.]     Q2 -- Yes --&gt; Q4[4 Does the CVBS data appear at TP - AV_CVBS ?]     Q4 -- No --&gt; A3[Check CN701. Change the Main Assy.]     Q4 -- Yes --&gt; Q2_2[2 Does the digital data appear at TP - O_TXCLK+, O_TXCLK-, F_TXCLK+, F_TXCLK- ?]     Q2_2 -- No --&gt; A4[Check IC1102 (SX1). Change the Main Assy.]     Q2_2 -- Yes --&gt; Q5[Check the LVDS cable? Check the T-Con B'd? Replace the LCD panel?]     Q5 -- No --&gt; A5[Please, Contact Tech support.]     </pre>
Caution	<p>Make sure to disconnect the power before working on the IP board.</p>

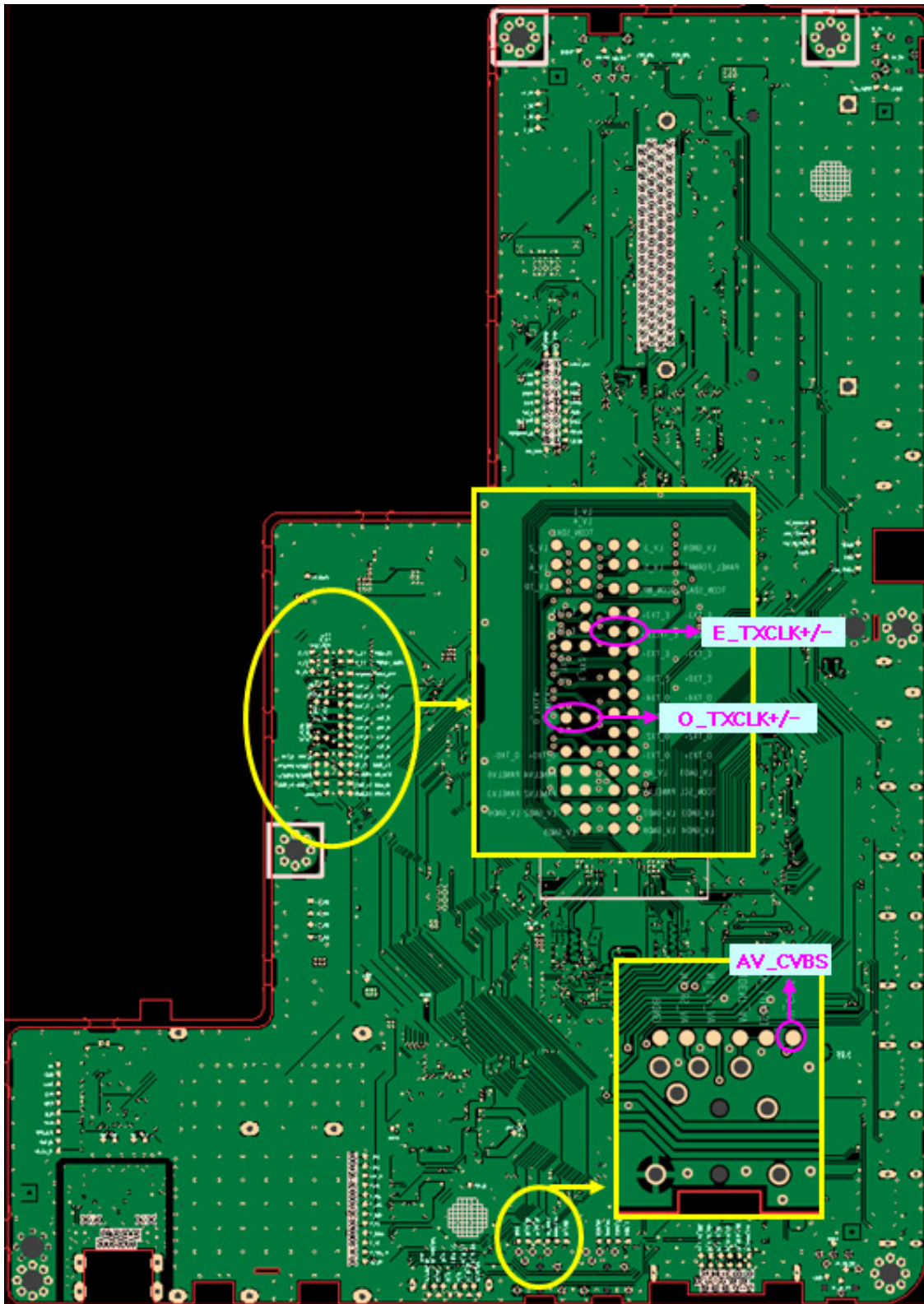

## ■ WAVEFORMS

### ④ CVBS OUT (Grey Bar)

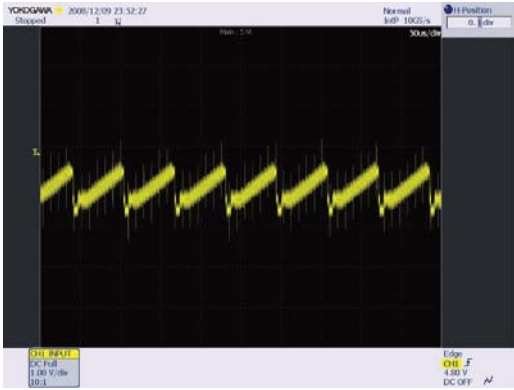

### ② LVDS output

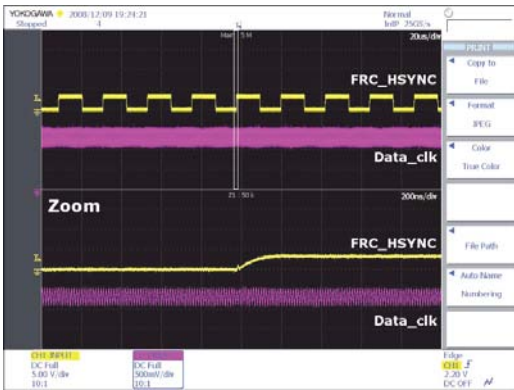

## 4-1-8. No Video (Component)

Symptom	<ul style="list-style-type: none"> <li>- Audio is normal but no picture is displayed on the screen.</li> </ul>
Major checkpoints	<ul style="list-style-type: none"> <li>- Check the Component source</li> <li>- Check the SX1.</li> <li>- This may happen when the LVDS cable connecting the Main Board and the Panel is disconnected.</li> </ul>
Diagnostics	<pre> graph TD     Q1[Power indicator LED is off. Lamp(Backlight) on, no video ?] -- No --&gt; A1[Check a set in the 'Stand-by mode']     Q1 -- Yes --&gt; Q2[Check the component source and check the connection of component cables(Y,Pb,Pr)?]     Q2 -- No --&gt; A2[Input the component source properly.]     Q2 -- Yes --&gt; Q3[5 Does the component data appear at TP-COMP_Y, COMP_PB, COMP_PR (Comp / Y, Pb, Pr) ?]     Q3 -- No --&gt; A3[Check CN802. Change the Main Assy.]     Q3 -- Yes --&gt; Q4[2 Does the digital data appear at TP - O_TXCLK+, O_TXCLK-, F_TXCLK+, F_TXCLK- ?]     Q4 -- No --&gt; A4[Check IC1102 (SX1). Change the Main Assy.]     Q4 -- Yes --&gt; Q5[Check the LVDS cable? Check the T-Con B'd? Replace the LCD panel?]     Q5 -- No --&gt; A5[Please, Contact Tech support.]   </pre>
Caution	Make sure to disconnect the power before working on the IP board.

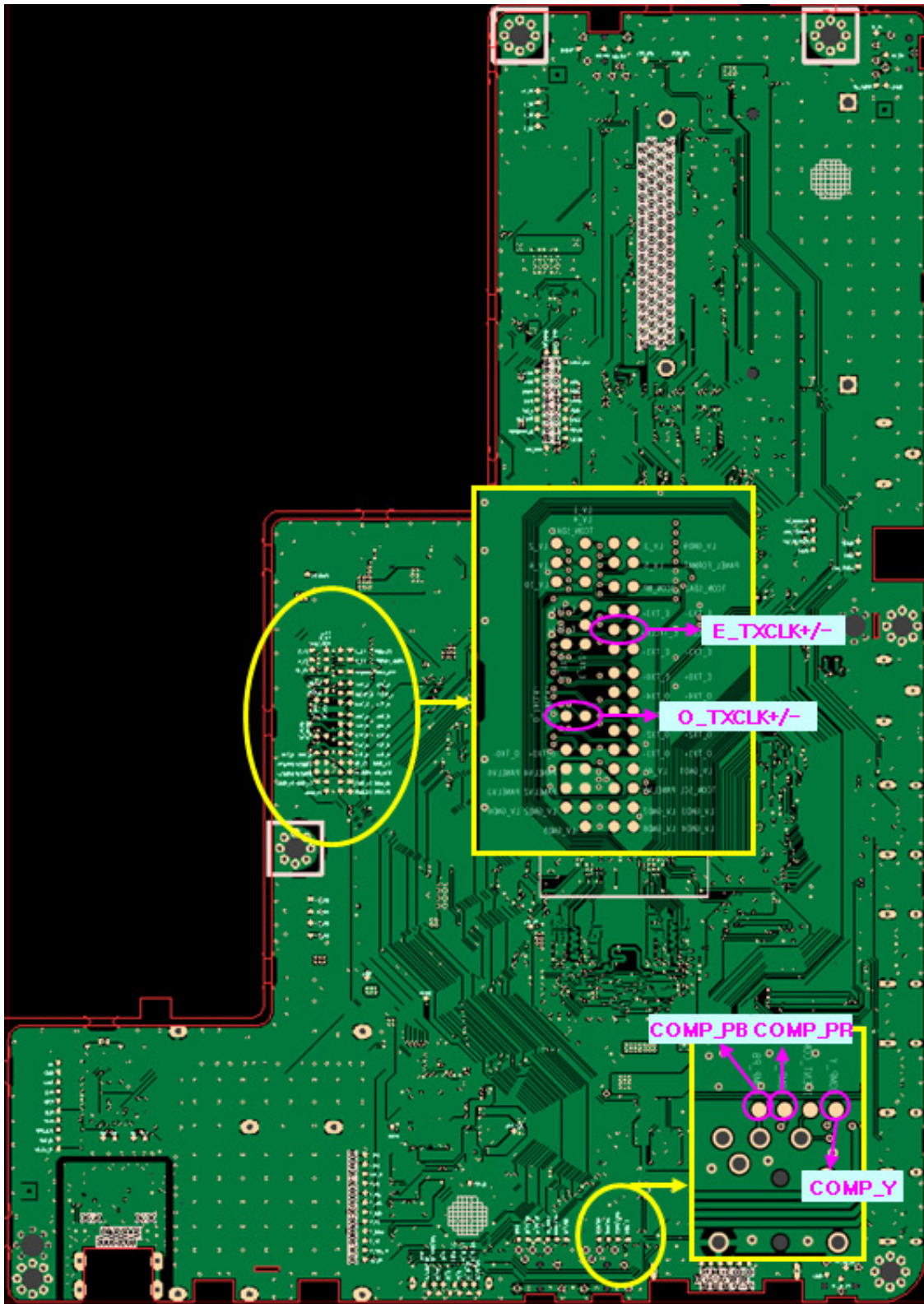

■ WAVEFORMS

5 Component\_Y (Gray scale) / Pb / Pr (Color bar)

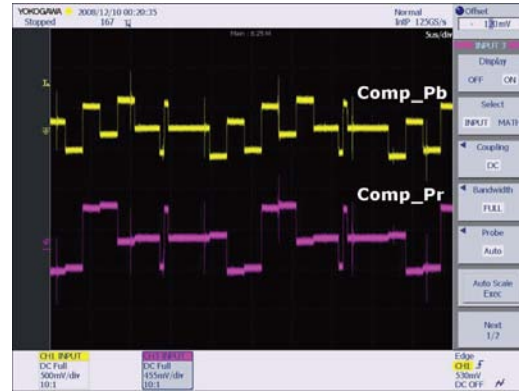

2 LVDS output

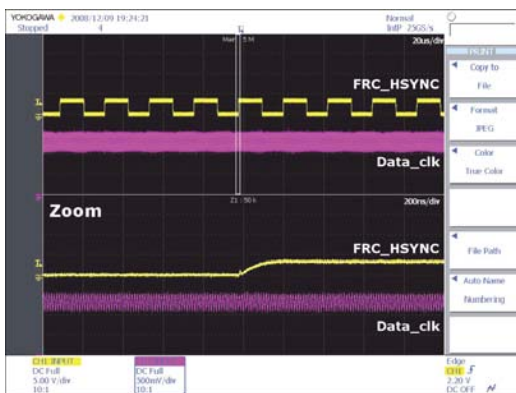

### 4-1-9. No Sound

Symptom	<ul style="list-style-type: none"> <li>- Video is normal but there is no sound..</li> </ul>
Major checkpoints	<ul style="list-style-type: none"> <li>- When the speaker connectors are disconnected or damaged.</li> <li>- When the sound processing part of the Main Board is not functioning.</li> <li>- Speaker defect.</li> </ul>
Diagnostics	<pre> graph TD     Q1[Check the source and check the connection of sound cable (Comp/PC/DVI to HDMI) ?] -- No --&gt; A1[Input the sound source properly.]     Q1 -- Yes --&gt; Q2[Does the sound data appear at TP-AV_SR_IN, AV_SL_IN (AV R/L) TP-PC_SR_IN, PC_SL_IN (PC R/L) TP-SC_SR_IN, SC_SL_IN (SCART R/L)?]     Q2 -- No --&gt; A2[Check CN801, CN901, JA701. Change the Main Assy.]     Q2 -- Yes --&gt; Q3[Does the DC B3.3V, B12VS appear at BD202, TP- B13VS?]     Q3 -- No --&gt; A3[Change the Main Assy.]     Q3 -- Yes --&gt; Q4[Does the sound data appear at TP - L-, L+, R-, R+ ?]     Q4 -- No --&gt; A4[Check IC1102(SX1). Check IC1301(Sound AMP). Change the Main Assy.]     Q4 -- Yes --&gt; Q5[Replace speaker ? TBD]     Q5 -- No --&gt; A5[Please, Contact Tech support.]     </pre>
Caution	<p>Make sure to disconnect the power before working on the IP board.</p>



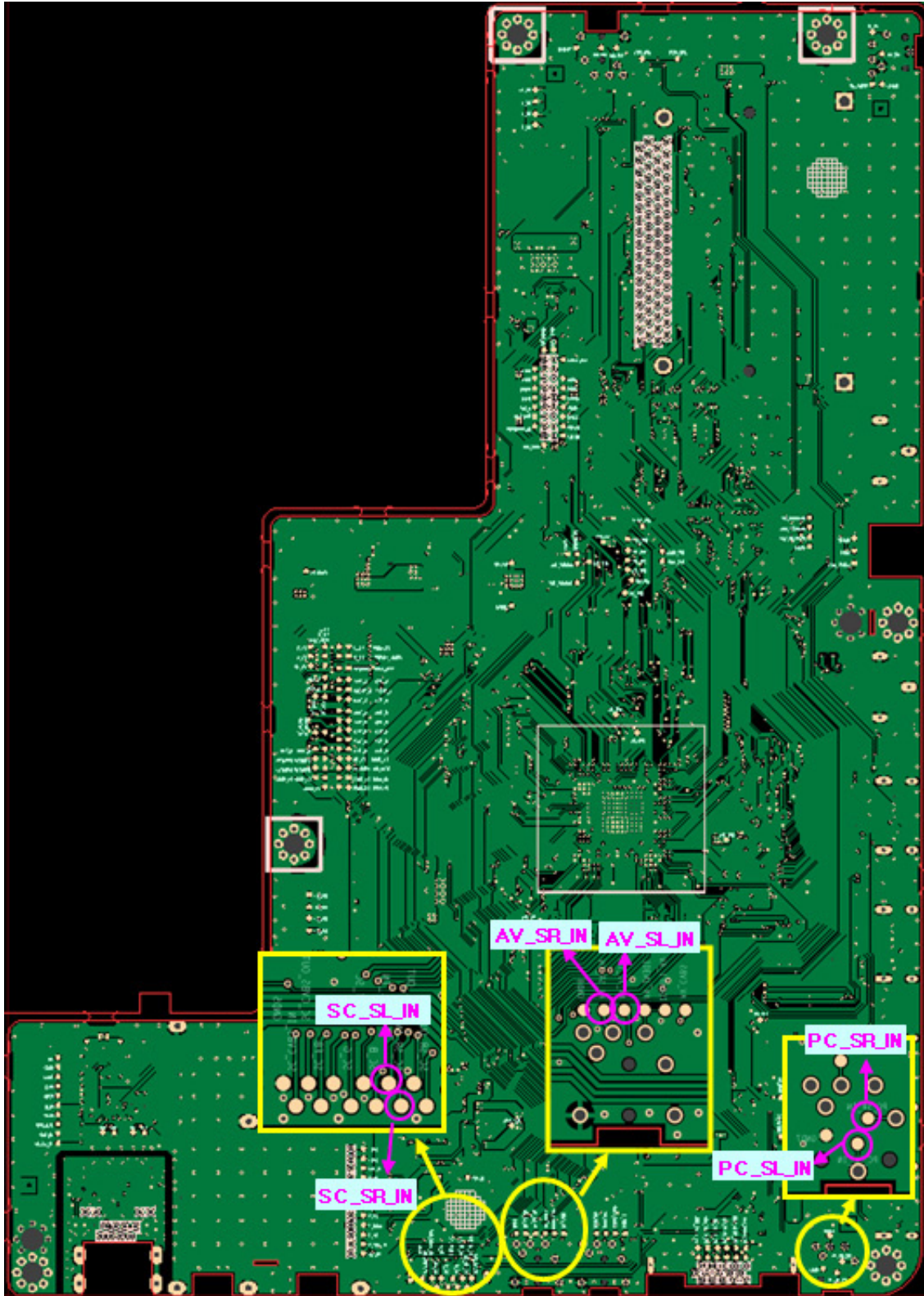

## ■ WAVEFORMS

### 7 Speaker out

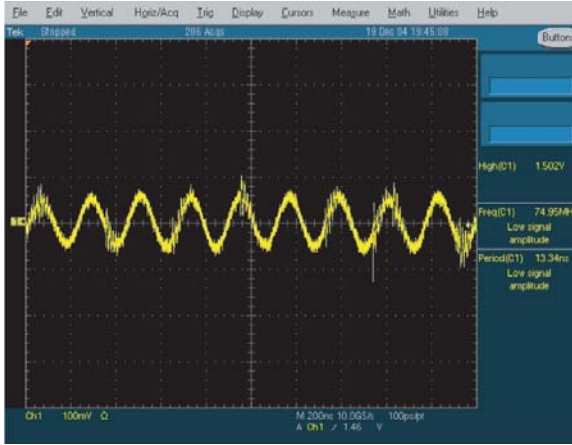

## 4-2. Alignments and Adjustments

### 4-2-1. General Alignment Instruction

1. Usually, a color LED TV needs only slight touch-up adjustment upon installation. Check the basic characteristics such as height, horizontal and vertical sync.
2. Use the specified test equipment or its equivalent.
3. Correct impedance matching is essential.
4. Avoid overload. Excessive signal from a sweep generator might overload the front-end of the TV. When inserting signal markers, do not allow the marker generator to distort test result.
5. Connect the TV only to an AC power source with voltage and frequency as specified on the backcover nameplate.
6. Do not attempt to connect or disconnect any wire while the TV is turned on. Make sure that the power cord is disconnected before replacing any parts.
7. To protect against shock hazard, use an isolation transformer.

## 4-3. Factory Mode Adjustments

### 4-3-1 Entering Factory Mode

To enter 'Service Mode' Press the remote -control keys in this sequence :

- If you do not have Factory remote - control



### 4-3-2 How to Access Service Mode

#### Using the Customer Remote

1. Turn the power off and set to stand-by mode.
2. Press the remote buttons in this order; POWER OFF- INFO - MENU - MUTE to turn the set on.
3. The set turns on and enters service mode. This may take approximately 20 seconds.
4. Press the Power button to exit and store data in memory.  
- If you fail to enter service mode, repeat steps 1 and 2 above.
5. Initial SERVICE MODE DISPLAY State

Option
Control
SVC
Expert
ADC/WB
Advanced
T-TDT5DEUC-XXXX T-TDT5DEUS-XXXX EDID SUCCESS CALIB : AV X COMP X PC X HDMI X Option : XXXX XXXX XXXX X
T-TDTDEU-XXX SDAL-XXX RFS : P0155 T-TDT5DEUC 20XX-XX-XX TYPE : XX MODEL : XXXXX MAC Not Available FACTORY DATA VER : XXX EERC VERSION : XXX DTP-AP-COMP-XXX-XX DTP-HIIG-XXXX-X DTP-BP-XXXX DATE OF PURCHASE : XX/XX/XX

\* How to enter the hidden factory mode.

- a. into the factory mode
- b. move the tap to Advanced
- c. key input : 0 + 0 + 0 + 0

\*\* hidden menu : Advanced

6. Buttons operations withn Service Mode

Menu	Full Menu Display/Move to Parent Menu
Direction Keys ▲/▼	Item Selection by Moving the Cursor
Direction Keys ◀/▶	Data Increase / Decrease for the Selected Item
Source	Cycles through the active input source that are connected to the unit

## 4-3-3 Factory Data

## ■ Option

OPTION	Factory Name	Data	Range	Use
	Factory Reset			
	Type		NONE/19O6TH0C/19A6TH0C/22I6TH0C/22A6TH0C/22D6TH0C/22P6TH0C/26A6AH0C/26D6AH0C/26L6AH0C/26P6AH0C/32A6AH0C32D6AH0C/32L6AH0C32P6AH0C/32A6AF0C/32L6AF0C/32A1AF0C/32L1AF0C/37L6AF0C/37L1AF0C/40A6AF0C/40D6AF0C/40L6AF0C/40A1AF0C/40L1AF0C/40A1UF0C/40D1UF0C/40L1UF0C/46A6AF0C/46D6AF0C/46L6AF0C/46A1AF0C/46L1AF0C/46A1UF0C/46D1UF0C/46L1UF0C/55A1UF0C/55L1UF0C/65L1UF0C/19R6TH0E/22D6TH0E/26D6AH0E/32D6AH0E32D6UF0E/32A1UF0E/32D1UF0E/37L6UF0E/37D1UF0E/37L1UF0E/40D6UF0E/40A1UF0E/40D1UF0E/46D6UF0E/46L6UF0E/46A1UF0E/46D1UF0E/46L1UF0E/55A1UF0E/55D1UF0E/55L1UF0E/65L1UF0E/42HHcD3/50HHcD450FArN4/50FArV458FArN1/58FArV163FArN1/	Select Panel Type ① ② : inch ③ : vendor ④ : refresh ⑤ : POL ⑥ : resolution ⑦ : multi ⑧ : BLU
	Local Set	EU	EU/EU_Italy/EU_Africa/EU_Israel/NORDIG/AD_Au/CIS	Select Area
	Model	UC5100	LC350/LC450/LC450H/LC451/LC452/LC457HLC459H/LC480/LC530/LC530H/LC539H/LC540/LC550/LC560/LC580/LC570/LC610/LC620/LC630/LC631/LC632/LC633/LC640/LC650/LC652/LC653/LC654/LC670/UC400/UC400H/UC4010/UC5000/UC5100/UC6000/UC6200/UC6300/UC6400/UC6400H/UC6500/UC6510/UC6530/UC6540/UC6550/UC6600/UC6620/UC6630/UC6700/UC6720/UC6730/UC6740/UC6800/UC6830/UC6900/UC6900H/UC8000/PC420/PC430/PC431/PC432/PC450/PC451/PC480/PC520/PC530/PC531/PC540/PC541/PC550/PC551/PC560/PC580/PC590/PC670/PC6100/PC6400/PC6500/PC7000/PC7700/PC8000	Select Model
	TUNER	DRXKSEMCO	DRXKSEMCO/S2Semco/T2CXD/DRXKSEM_E/DRXKALPS/DRXKSEN_2/DRXKXG	EU : DRXKSEMCO AU : DRXKALPS satellite : S2Semco
	DDR	SAMSUNG / Etron	SAMSUNG	SAMSUNG
	Front Color		NONE/W-MILKY/T-M-Brn/T-W-Brn/T-W-Gray/W-D-Gray/W-M-Whit/W-Violet/T-C-Gray/T-R-BLK/S-BLK/S-RBLK/S-C-Gray/	Select Design for Illuminance Sensor

## ■ Control

Control	Factory Name	Data	Range
	EDID		
	Sub Option		
	Shop Option		
	Sound		

EDID	Factory Name	Data	Use
	EDID ON/OFF	OFF	<p><b>Download EDID data to EEPROM.</b></p> <ol style="list-style-type: none"> <li>1. Set "ON" of EDID ON/OFF.</li> <li>2. Go EDID WRITE ALL and Push Enter or ► button.</li> <li>3. If You See Success message, SET "OFF" of EDID ON/OFF.</li> </ol>
	EDID WRITE ALL	...	
	EDID WRITE PC	...	
	EDID WRITE HDMI	...	
	EDID WRITE HDMI1	...	
	EDID WRITE HDMI2	...	
	EDID WRITE HDMI3	...	
	EDID WRITE HDMI4	...	
	EDID 1.2 PORT	...	
	EDID WRITE DVI	...	

Sub Option	Factory Name	Data	RANGE	Use
	RS-232 Jack	UART	Debug/Logic/UART	Select Setting of UART port. Initial value is "UART"
	Watchdog	ON	ON/OFF	Select Watchdog. Initial value is "ON"
	WD Count	0	255	Watchdog Count. Read Only.
	Dimm Type	EXT	fixed	Select Dimming Type. Initial value is "EXT"
	Lvds Format	JEIDA	JEIDA/VESA/19INCH	Select LVDS format. 19inch : "VESA" other inch : "JEIDA"
	OTN Server Type	operating	operating/development	
	OTN Test Server	OFF	OFF/ A/B/C/D/E Zone	
	OTN Support	ON	ON/OFF	
	OTN Reset		not modified	
	OTN Duration	OFF	ON/OFF	
	OTN Fail Test	OFF	ON/OFF	
	T-CON USB Download	Failure	fixed	
	View Log		not modified	

<b>Hotel Option</b>	<b>Factory Name</b>	<b>Data</b>	<b>Range</b>	
	Hotel Mode	OFF		
	SI Vender	...		
	Power On Channel	...		
	Channel Type	...		
	Power On Volume	...		
	Min Volume	...		
	Max Volume	...		
	Panel Button Lock	...		
	Power On Source	...		

<b>Shop Option</b>	<b>Factory Name</b>	<b>Data</b>	<b>Range</b>	
	Shop Mode	OFF	ON/OFF	
	Exhibition Mode	OFF	ON/OFF	

<b>Sound</b>	<b>Factory Name</b>	<b>Data</b>	<b>Range</b>	<b>Use</b>
	High Devi	OFF	ON/OFF	
	Carrier_Mute	ON	ON/OFF	
	Speaker Delay Normal	10	0~255	Audio delay for Lipsync
	Pilot Level High Thld	0x70h	0x00~0xff	Control for ATV sound of stereo / multiplex
	Pilot Level Low Thld	0x20h	0x00~0xff	Control for ATV sound of stereo / multiplex
	Speaker EQ	ON	ON/OFF	Control for sound precision

## ■ SVC

<b>SVC</b>	<b>Factory Name</b>	<b>Data</b>	<b>Range</b>
	Test Pattern		fixed
	Panel Auto Setting		
	Panel Display Time	0Hr	
	Logic Usb D/L	off	
	Tuner Status		

<b>Test Pattern</b>	<b>Factory Name</b>	<b>Data</b>	<b>Range</b>	<b>Use</b>
	Pattern Sel	OFF	OFF/ White/Grey/Black Red/Green/Blue	Test for Input of Scaler. If you can see pattern well, there is problem at input of Scaler.
	FRC PC Mode	...	ON/OFF	
	Logic Pattern Sel	...	Not modified	
	Logic Level Sel	...	Not modified	

<b>TUNER STATUS</b>	<b>Factory Name</b>	<b>Factory Name</b>	<b>Range</b>
	DVB	SNR	Not modified
		BER	Not modified
		Singal Strength	Not modified
		Bandwidth	Not modified
		Frequency	Not modified
		LNA Status	Not modified
		FFT	Not modified
		Modulation	Not modified
		Code Rate	Not modified
		GI	Not modified
		Hier Modulation	Not modified
		Frequency Offset	Not modified
		Timing Offset	Not modified
		AGC	Not modified
		UCB	Not modified
		PLL Type	Not modified
		DEMOD Type	Not modified
		TPS LOCK	Not modified
		RS Lock	Not modified
		SSI	Not modified
SQI	Not modified		



ISDB-T	FFT Size_1	Not modified
	Guard Interval_1	Not modified
	Freq. Offset_1	Not modified
	SNR_1	Not modified
	IF AGC_1	Not modified
	TMCC Lock_1	Not modified
	TS Packet_1	Not modified
	Master Lock_1	Not modified
	A_Modulation_1	Not modified
	A_Code Rate_1	Not modified
	A_Timer InterLeave_1	Not modified
	A_Segments Num_1	Not modified
	A_Ber_1	Not modified
	B_Modulation_1	Not modified
	B_Code Rate_1	Not modified
	B_Timer InterLeave_1	Not modified
	B_Segments Num_1	Not modified
	B_BER_1	Not modified
	C_Modulation_1	Not modified
	C_Code Rate_1	Not modified
	C_Timer InterLeave_1	Not modified
C_Segments Num_1	Not modified	
C_BER_1	Not modified	

### ■ Expert

<b>SVC</b>	<b>Factory Name</b>	<b>Data</b>	<b>Range</b>
	N / D ADJ	Off	Off / On / FIX
	SOURCE	...	Not modified

## ■ ADC/WB

ADC/WB	Factory Name	Data	Range
	ADC		
	ADC Target		
	ADC RESULT		
	WB		

ADC	Factory Name	Data	Range
	AV Calibration	Success	Success / Failure
	Comp Calibration	Success	Success / Failure
	PC Calibration	Success	Success / Failure
	HDMI Calibration	Success	Success / Failure

ADC Target	Factory Name	Data	Range
	1st_AV_Low	64	0 ~ 1023
	1st_AV_High	880	0 ~ 1023
	1st_AV_Delta	2	0 ~ 7
	1st_COMP_Y_Low	64	0 ~ 1023
	1st_COMP_Y_High	940	0 ~ 1023
	1st_COMP_Delta	2	0 ~ 7
	1st_PC_R_Low	16	0 ~ 1023
	1st_PC_R_High	1004	0 ~ 1023
	1st_PC_Delta	2	0 ~ 7
	2nd_AV_R_Low	4	-
	2nd_AV_G_Low	4	0 ~ 1023
	2nd_AV_B_Low	4	-
	2nd_AV_R_High	940	-
	2nd_AV_G_High	940	0 ~ 1023
	2nd_AV_B_High	940	-
	2nd_AV_Delta	2	0 ~ 7
	2nd_COMP_R_Low	4	-
	2nd_COMP_G_Low	4	0 ~ 1023
	2nd_COMP_B_Low	4	-
	2nd_COMP_R_High	940	-
	2nd_COMP_G_High	940	0 ~ 1023
	2nd_COMP_B_High	940	-
	2nd_COMP_Delta	2	0 ~ 7
	2nd_PC_R_Low	4	-
	2nd_PC_G_Low	4	0 ~ 1023
	2nd_PC_B_Low	4	-

2nd_PC_R_High	940	-
2nd_PC_G_High	940	0 ~ 1023
2nd_PC_B_High	940	-
2nd_PC_Delta	2	0 ~ 7
2nd_HDMI_R_Low	4	-
2nd_HDMI_G_Low	4	0 ~ 1023
2nd_HDMI_B_Low	4	-
2nd_HDMI_R_High	940	-
2nd_HDMI_G_High	940	0 ~ 1023
2nd_HDMI_B_High	940	-
2nd_HDMI_Delta	2	0 ~ 7

ADC RESULT	Factory Name	Data	Range
	1st_Y_GH	0	0 ~ 255
	1st_Y_GL	0	0 ~ 255
	1st_Cb_BH	0	0 ~ 255
	1st_Cb_BL	0	0 ~ 255
	1st_Cr_RH	0	0 ~ 255
	1st_Cr_RL	0	0 ~ 255
	2nd_R_L	132	0 ~ 255
	2nd_G_L	132	0 ~ 255
	2nd_B_L	132	0 ~ 255
	2nd_R_H	50	0 ~ 255
	2nd_G_H	50	0 ~ 255
	2nd_B_H	50	0 ~ 255

WB	Factory Name	Data	Range
	Sub Brightness	128	0 ~ 255
	R_Offset	512	0 ~ 1023
	G_Offset	512	0 ~ 1023
	B_Offset	512	0 ~ 1023
	Sub Contrast	128	0 ~ 255
	R_Gain	512	0 ~ 1023
	G_Gain	512	0 ~ 1023
	B_Gain	512	0 ~ 1023
	Movie R Offset	-	0 ~ 1023
	Movie B Offset	-	0 ~ 1023
	Movie R Gain	-	0 ~ 1023
	Movie B Gain	-	0 ~ 1023

## 4-4. White Balance

### 4-4-1. Calibration

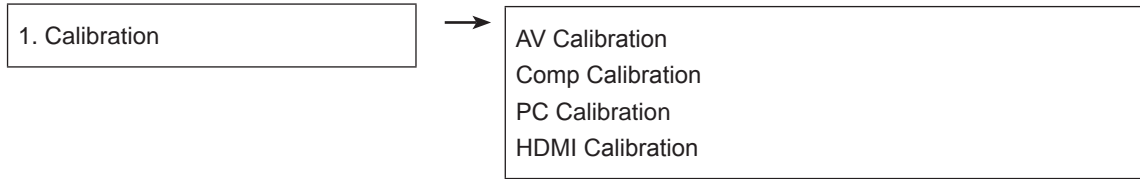

### 4-4-2. Adjustment

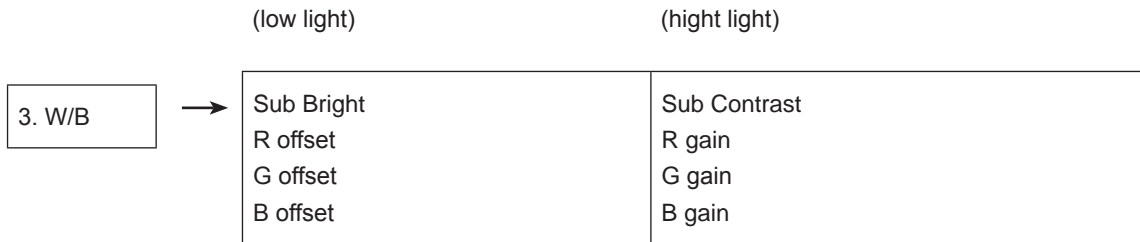

(W/B adjustment Condition refer next page)

## 4-5. White Ratio (Balance) Adjustment

- You can adjust the white ratio in factory mode (1:Calibration, 3:White-Balance).
- Since the adjustment value and the data value vary depending on the input source, you have to adjust these in CVBS, Component 1 and HDMI 1 modes.
- The optimal values for each mode are configured by default. (Refer to Table 1, 2)  
It varies with Panel's size and Specification.
  - Equipment : CS-210
  - Pattern: MIK K-7256 #92 "Flat W/B Pattern" as standard
  - Use other equipment only after comparing the result with that of the Master equipment.
  - Set Aging time : 60min ↑
  - Calibration and Manual setting for WB adjustment.

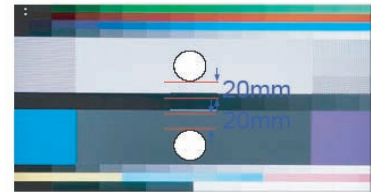

- HDMI : Calibration at #24 Chessboard Pattern → Manual adjustment #92 pattern (720p)
- COMP: Calibration at #24 Chessboard Pattern → Manual adjustment at #92 pattern (720p)
- CVBS: Calibration at #24 Chessboard Pattern → Manual adjustment at #92 pattern (PAL)

- If finishing in HDMI mode, adjustment coordinate is almost same in AV/COMP mode.
- White Balance Manual Adjustment

P-Mode	Adjustment Coordinate				
		x	y	Y (Luminance)	T(K) + MPCD
CVBS (PAL)	H/L	272	278	- (Sub_CT:130)	12,000 (±0)
	L/L	272	278	12.6cd/m <sup>2</sup> (3.7 Ft)	12,000 (±0)
COMP (720P)	H/L	272	278	- (Sub_CT:130)	12,000 (±0)
	L/L	272	278	13.0cd/m <sup>2</sup> (3.8 Ft)	12,000 (±0)
HDMI (720P)	H/L	272	278	- (Sub_CT:130)	12,000 (±0)
	L/L	272	278	13.0cd/m <sup>2</sup> (3.8 Ft)	12,000 (±0)

- Adjustment Specification

White Balance : High light (±1), Low light (±3)  
Luminance : High light (Don't care), Low light (±0.2 Ft/L)

## 4-6. Servicing Information

### 4-6-1 USB Download Method

Samsung may offer upgrades for TV's firmware in the future. Please contact the Samsung call center at 1-800-SAMSUNG (726-7864) to receive information about downloading upgrades and using a USB drive. Upgrades will be possible by connecting a USB drive to the USB port located on your TV.

1. Insert a USB drive containing the firmware (T-TDT5DEUC) upgrade into the USB port on the rear of the TV.
2. Press the **MENU** button to display the menu.  
Press the **▲** or **▼** button to select "Support", then press the **ENTER** button.
3. Press the **▲** or **▼** button to select "SW Upgrade", then press the **ENTER** button.  
The message "Scanning for USB. It may take up to 30 seconds." is displayed.
4. The message "Upgrade version XXXX to version XXXX?  
The system will be reset after upgrade." is displayed.  
Press the **◀** or **▶** to select the "OK", then press the **ENTER** button.

Please be careful to not disconnect the power or remove the USB drive while upgrades are being applied. The TV will turn off and turn on automatically after completing the firmware upgrade. Please check the firmware version after the upgrades are complete. When software is upgraded, video and audio settings you have made will return to their default (factory) settings. We recommend you write down your settings so that you can easily reset them after the upgrade.

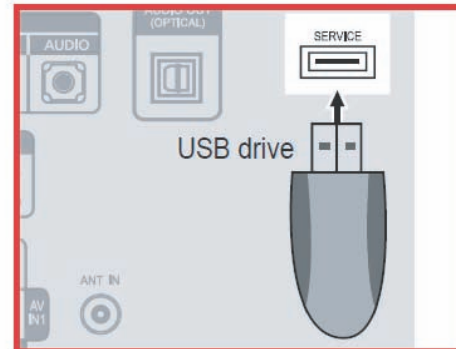

## 4-7. How To Upgrade Sub Micom With Ddc Manager

### 4-7-1. TV Sub S/W

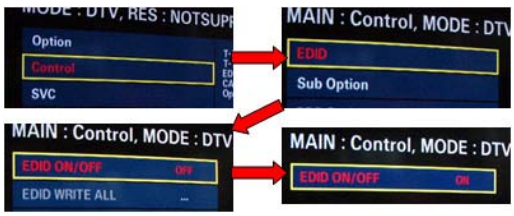
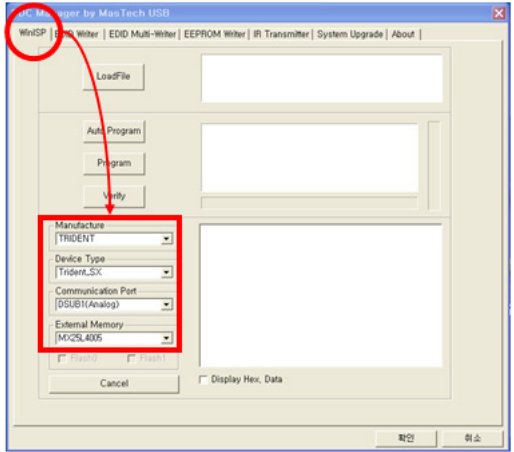
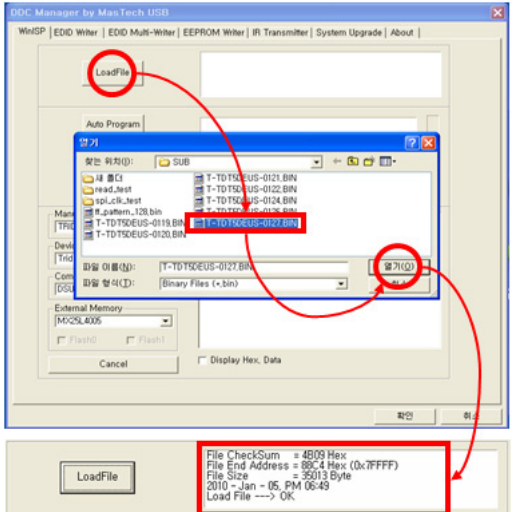
Order	Description	
1	Connect DDC MANAGER to the TV Set with D-SUB cable. And Power on. (USB type : MTI-2510 / parallel type : MTI-2059)	
2	Enter the factory mode. Control - EDID - EDID ON/OFF Select ON.	
3	Open the DDC tool. (Parallel type & USB type)	
4	Load the sub micom program file (T-TDT5DEUS-XXXX.BIN).	



## 4-8. PCB diagram

### 4-8-1. PCB layout

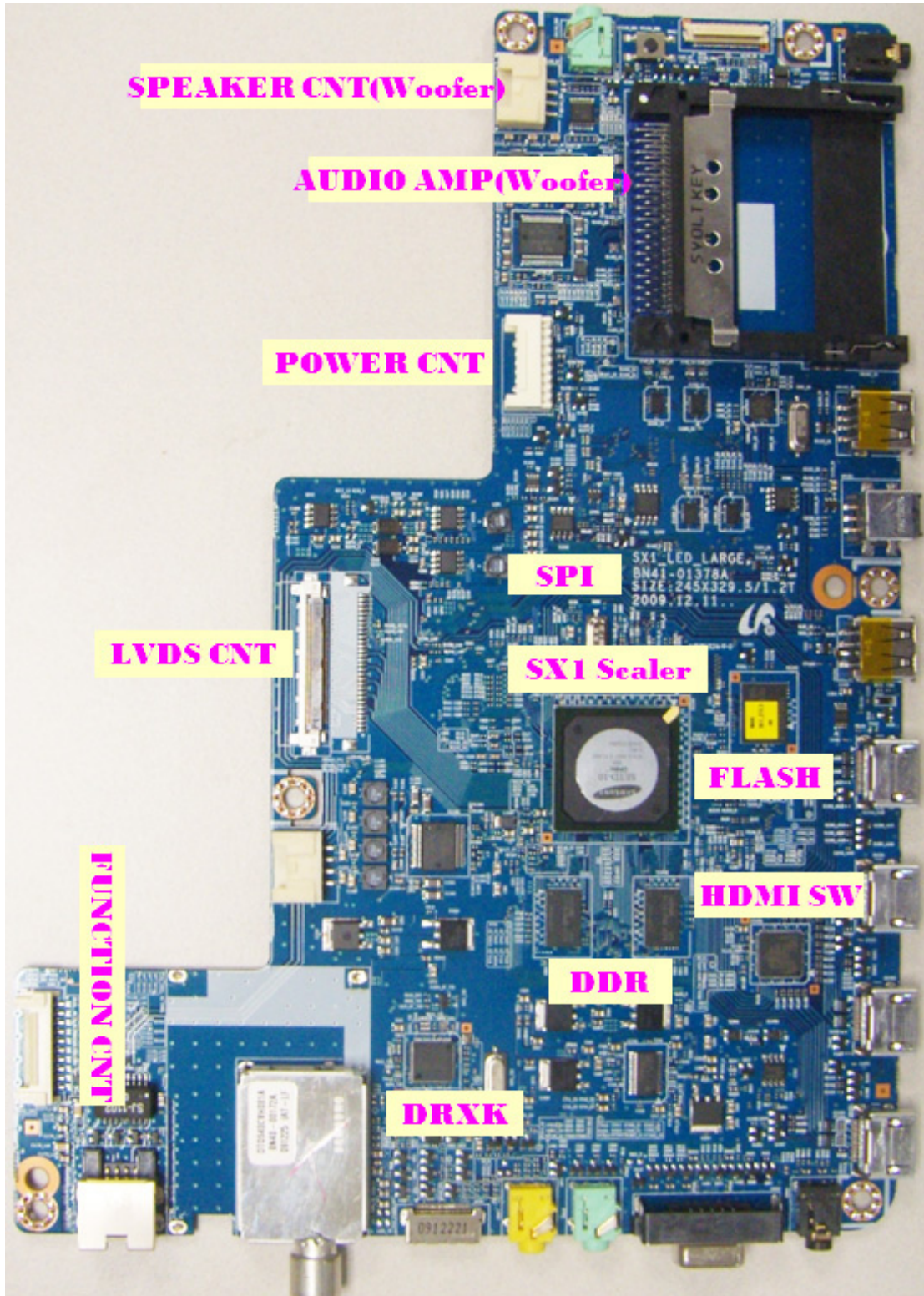



### 4-8-2. Main TOP

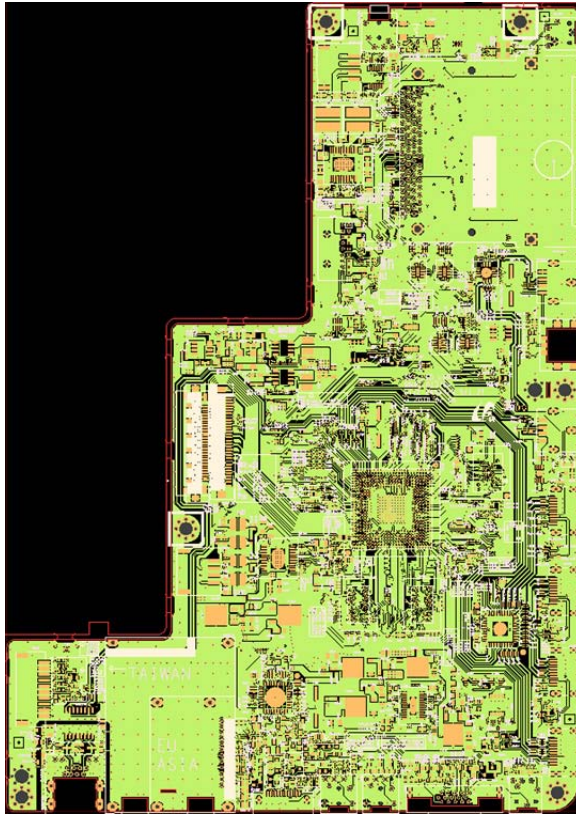

### 4-8-3. Main Inner(2)

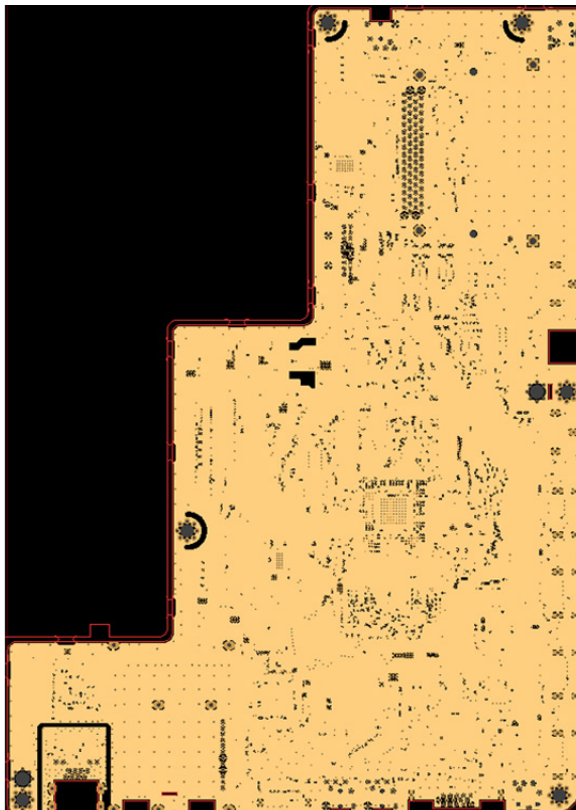

### 4-8-4. Main Inner(3)

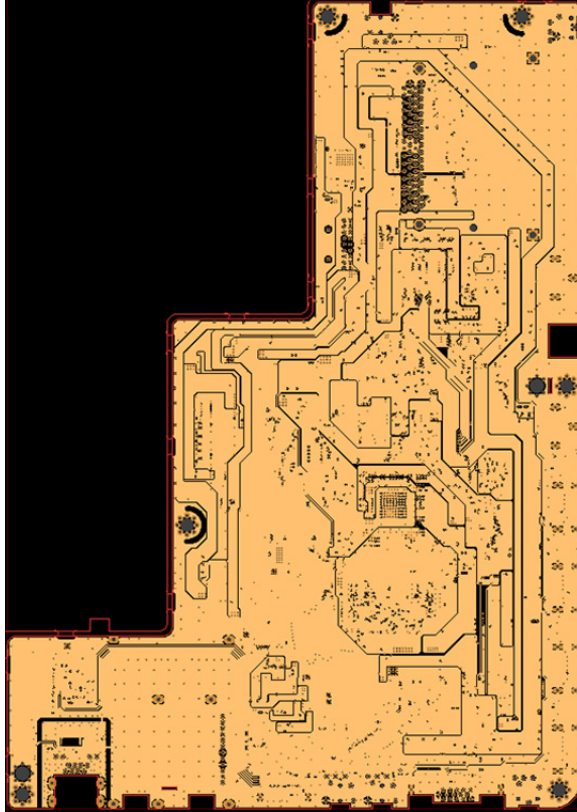

### 4-8-5. Main Bottom

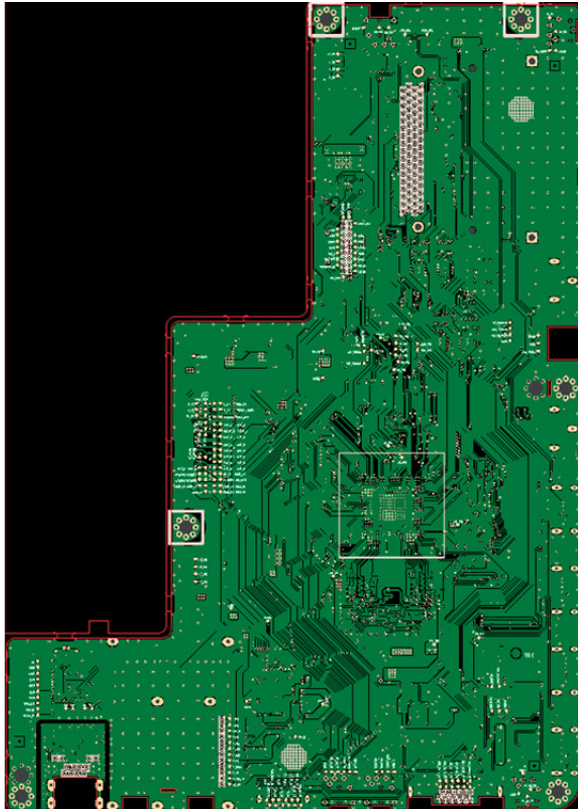

4-8-6. Power\_32"/37" SMPS

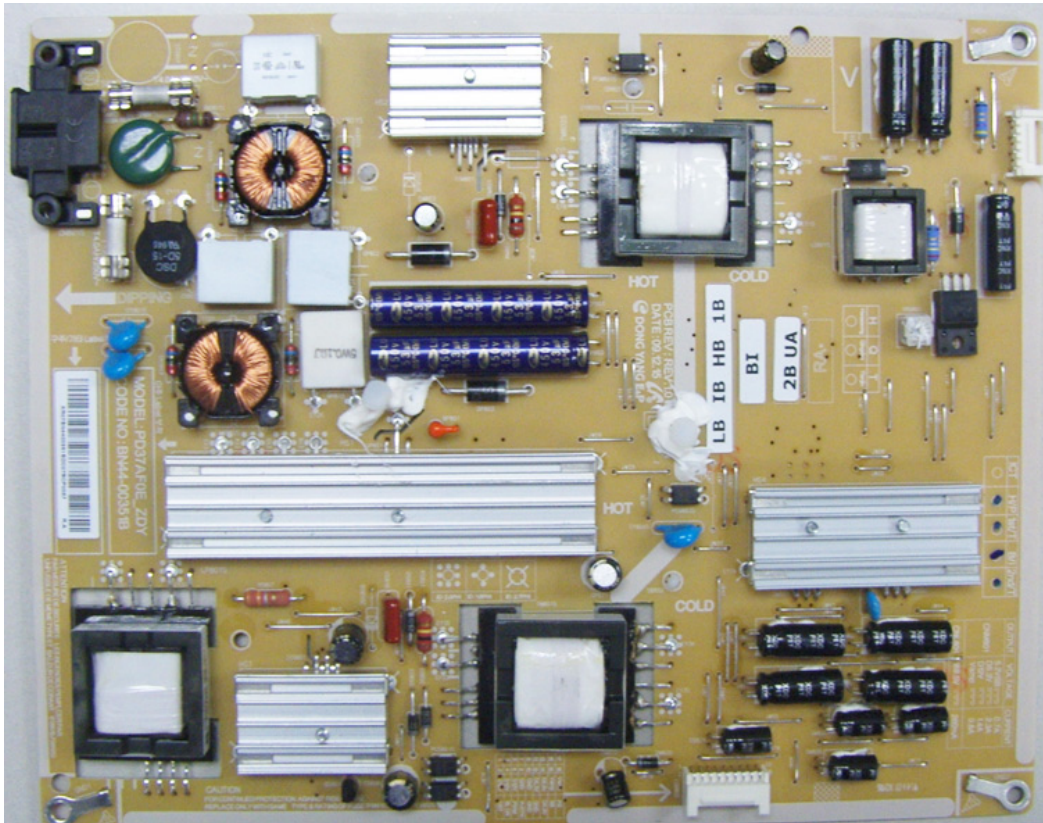

4-8-7. Power\_40" SMPS

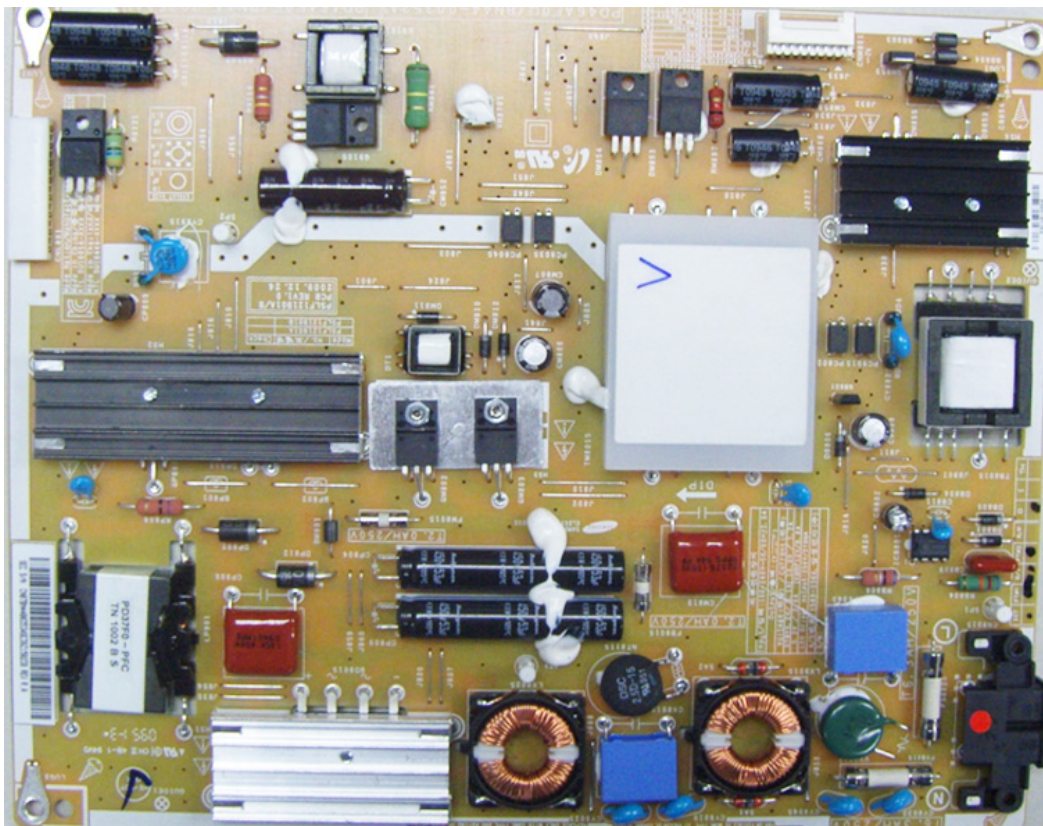

### 4-8-8. Power\_46" SMPS

