

Service Manual



Colour Television TX-32PK25

EURO-4H Chassis

SPECIFICATIONS

Power Source:	220-240V a.c., 50Hz
Power Consumption:	140W
Stand-by Power Consumption:	1.4W
Aerial Impedance:	75Ω unbalanced, Coaxial Type
Receiving System:	PAL-I , PAL-525/60 UHF M.NTSC NTSC (AV only)
Receiving Channels:	UHF E21-E69
Intermediate Frequency:	
Video/Audio	
Video	39.5MHz
Audio	33.5MHz
Colour	32.95MHz (NICAM) 35.07MHz (PAL)
Video/Audio Terminals:	
AUDIO MONITOR OUT	Audio (RCAX2) 500mV rms 1kΩ
AV1 IN	Video (21 pin) 1V p-p 75Ω Audio (21 pin) 500mV rms 10kΩ RGB (21 pin)
AV1 OUT	Video (21 pin) 1V p-p 75Ω Audio (21 pin) 500mV rms 1kΩ
AV2 IN	Video (21 pin) 1V p-p 75Ω Audio (21 pin) 500mV rms 10kΩ S-Video IN Y: 1V p-p 75Ω (21-pin) C:0,3V p-p 75Ω
AV2 OUT	Video (21 pin) 1V p-p 75Ω Audio (21 pin) 500mV rms 1kΩ Selectable output (21 pin)

AV3 IN	S-Video IN (4-pin) Audio (RCAX2) Video (RCAX1)	Y: 1V p-p 75Ω C: 0,3V p-p 75Ω 500mV rms 10kΩ 1V p-p 75Ω
AV4 IN	Video (21 pin) Audio (21 pin) S-Video IN (21-pin) RGB (21 pin)	1V p-p 75Ω 500mV rms 10kΩ Y: 1V p-p 75Ω C: 0.3V p-p 75Ω
AV4 OUT	Video (21 pin) Audio (21 pin)	1V p-p 75Ω 500mV rms 1kΩ

High Voltage:	32kV ± 1kV
Picture Tube:	W76EKW10X71 76cm
Audio Output:	2 x 15W (Music Power) 8Ω Impedance
Headphones:	8Ω Impedance 3.5mm
Accessories supplied :	Remote Control 2 x R6 (UM3) Batteries
Dimensions:	
Height:	503mm
Width:	720mm
Depth:	527mm
Net weight:	57kg

Specifications are subject to change without notice.
Weights and dimensions shown are approximate.

NOTE: This Service Manual should be used in conjunction with the EURO-4H Technical guide.

CONTENTS

SAFETY PRECAUTIONS.....	2
SERVICE HINTS.....	3
ADJUSTMENT PROCEDURE AND FACTORY SETTINGS.....	4
WAVEFORM PATTERN TABLE.....	5
ALIGNMENT SETTINGS.....	6
BLOCK DIAGRAMS.....	7
PARTS LOCATION.....	11
REPLACEMENT PARTS LIST.....	12
SCHEMATIC DIAGRAMS.....	23
CONDUCTOR VIEWS.....	30

SAFETY PRECAUTIONS

GENERAL GUIDE LINES

1. It is advisable to insert an isolation transformer in the a.c. supply before servicing a hot chassis.
2. When servicing, observe the original lead dress in the high voltage circuits. If a short circuit is found, replace all parts that have been overheated or damaged by the short circuit.
3. After servicing, see that all the protective devices such as insulation barriers, insulation papers, shields and isolation R-C combinations are correctly installed.
4. When the receiver is not being used for a long period of time, unplug the power cord from the a.c. outlet.
5. Potentials as high as 33kV are present when this receiver is in operation. Operation of the receiver without the rear cover involves the danger of a shock hazard from the receiver power supply. Servicing should not be attempted by anyone who is not familiar with the precautions necessary when working on high voltage equipment. Always discharge the anode of the tube.
6. After servicing make the following leakage current checks to prevent the customer from being exposed to shock hazard.

LEAKAGE CURRENT COLD CHECK

1. Unplug the a.c. cord and connect a jumper between the two prongs of the plug.
2. Turn on the receiver's power switch.
3. Measure the resistance value with an ohmmeter, between the jumpered a.c. plug and each exposed metallic cabinet part on the receiver, such as screw heads, aerials, connectors, control shafts etc. When the exposed metallic part has a return path to the chassis, the reading should be between 4M ohm and 20M ohm. When the exposed metal does not have a return path to the chassis, the reading must be infinite.

LEAKAGE CURRENT HOT CHECK

1. Plug the a.c. cord directly into the a.c. outlet. Do not use an isolation transformer for this check.
2. Connect a 2kΩ 10W resistor in series with an exposed metallic part on the receiver and an earth, such as a water pipe.
3. Use an a.c. voltmeter with high impedance to measure the potential across the resistor.

4. Check each exposed metallic part and check the voltage at each point.
5. Reverse the a.c. plug at the outlet and repeat each of the above measurements.
6. The potential at any point should not exceed 1,4Vrms. In case a measurement is outside the limits specified, there is a possibility of a shock hazard, and the receiver should be repaired and rechecked before it is returned to the customer.

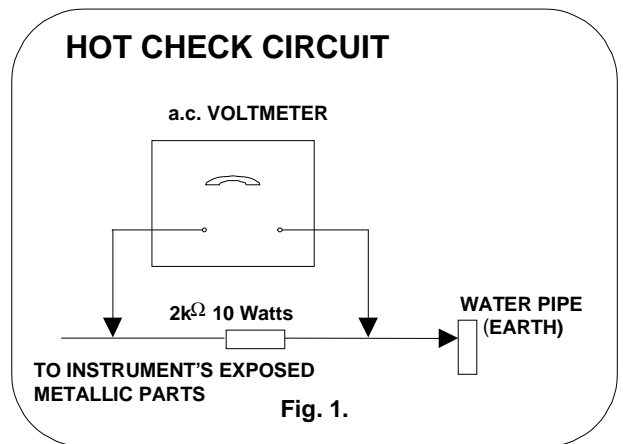

X-RADIATION WARNING

1. The potential sources of X-Radiation in TV sets are the high voltage section and the picture tube.
2. When using a picture tube test jig for service, ensure that the jig is capable of handling 33kV without causing X-Radiation.

NOTE: It is important to use an accurate periodically calibrated high voltage meter.

1. Set the brightness to minimum.
2. Measure the high voltage. The meter should indicate. 32kV ± 1kV.
If the meter indication is out of tolerance, immediate service and correction is required to prevent the possibility of premature component failure.
3. To prevent any X-Radiation possibility, it is essential to use the specified tube.

SERVICE HINTS

How to remove the rear cover

1. Remove the 10 screws as shown in Fig.2.



Fig. 2.

LOCATION OF CONTROLS

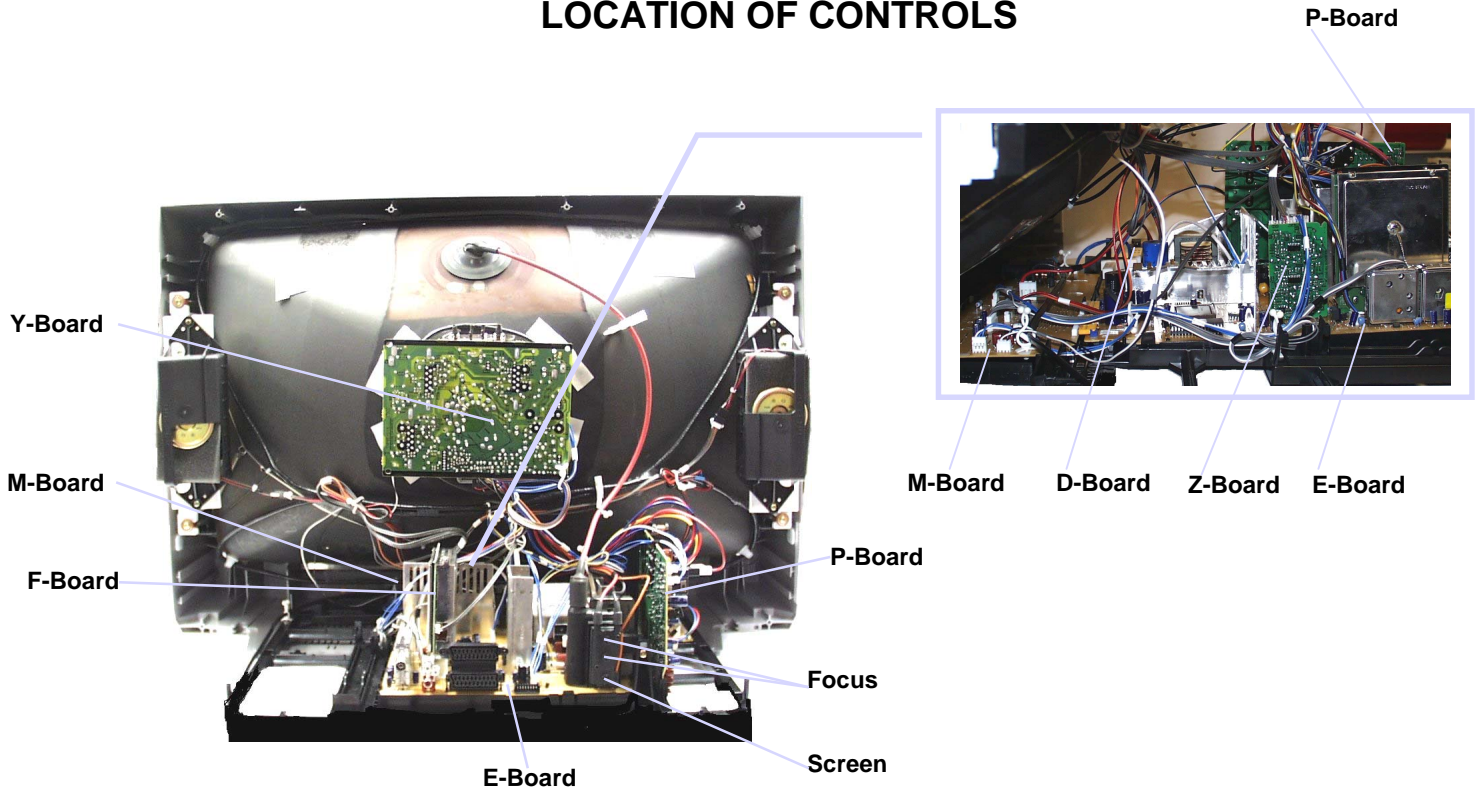

ADJUSTMENT PROCEDURE

Item / Preparation	Adjustments
+B SET-UP 1. Receive a Greyscale signal. 2. Set the controls :- Brightness Minimum Contrast Minimum Volume Minimum	1. Set the +B voltage up as follows:- Adjust R811 so that B2 shows 148V±1V. 2. Confirm the following voltages. B9 5 ± 0,25V B10 5 ± 0,25V B5 12 ± 0,5V B11 33 ± 1,5V B4 15 ± 1V B7 8 ± 0,5V B12 26 ± 2V B8 6 ± 1V B3 36 ± 1,5V B13 13 ± 1V B1 205 ± 10V B14 14 ± 1V
CUT OFF / Ug2 Test 1. Receive a Greyscale signal. 2. Degauss the tube externally. 3. Set the TV into Service Mode 1. 4. Select Cut off mode.	To adjust Cutoff connect an oscilloscope to the Blue cathode. Press " STR " and adjust "cutoff" value using the " Yellow " and " Blue " buttons until the black level is 160V±5V, press " STR " to store the value. Remove the oscilloscope. Select Ug2 adjustment and adjust the screen VR until the display shows "O.K."

FACTORY SETTINGS

Self-check is used to automatically check the bus lines and hexadecimal code of the TV set. To get in to Self-Check mode press the down **(-V)** button on the customer controls at the front of the TV set, at the same time pressing the **STATUS** button on the remote control.

VPC	O.K.	PCB	O.K.
SRC	O.K.	CAB	O.K.
DDP	O.K.		
TUN	O.K.		
E2	O.K.		
MSP	O.K.		
DPL	--		

TX- 32PK25

OPTION1 00

OPTION2 A1

OPTION3 02

OPTION4 C0

OPTION5 B1

OPTION6 E1

To exit Self Check, switch off the TV set at the power button.

If the CCU ports have been checked and found to be incorrect or not located then " - - " will appear in place of "O.K.".

WAVEFORM PATTERN TABLE

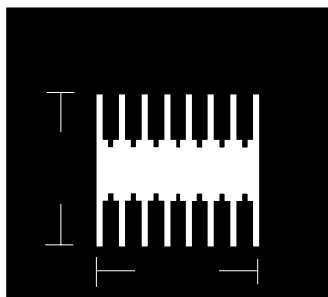
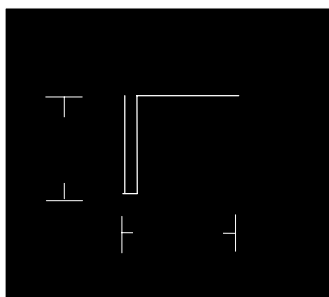
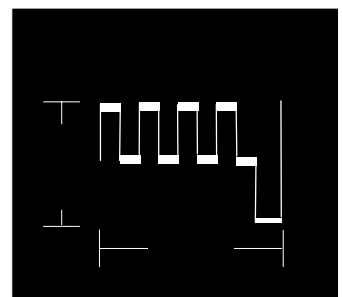
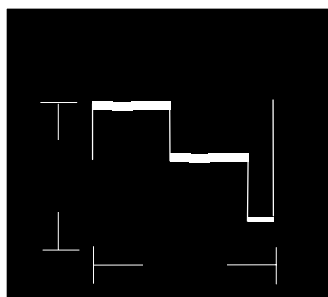
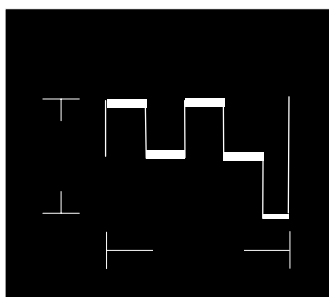
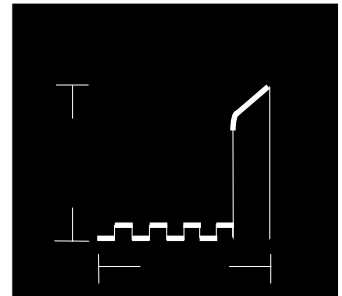
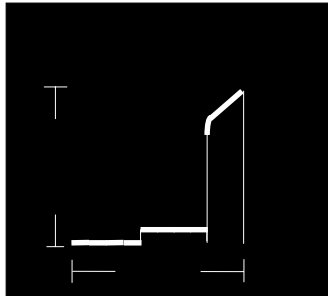
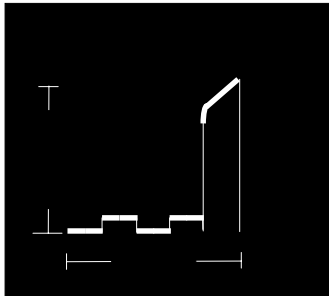
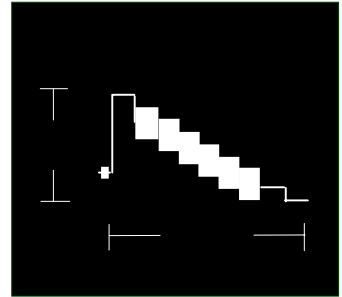
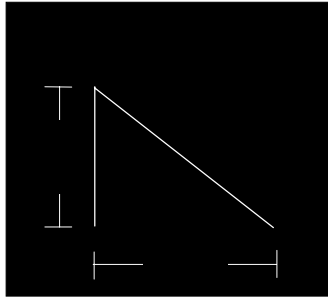
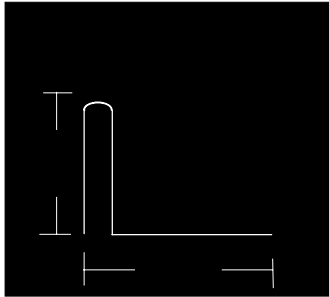
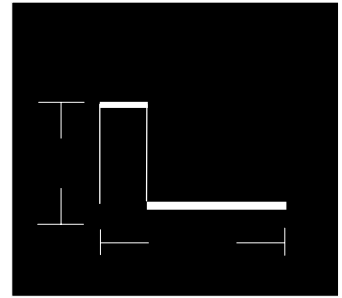
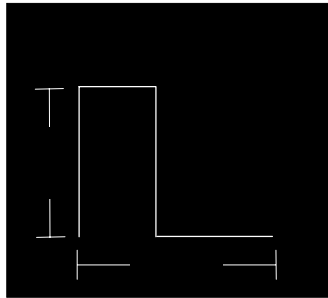
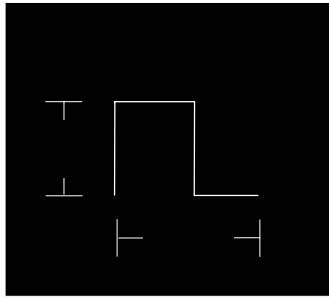
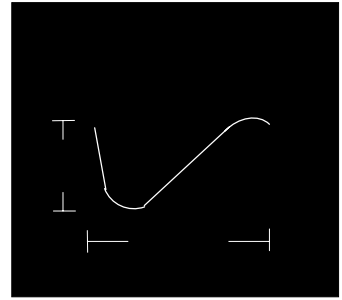
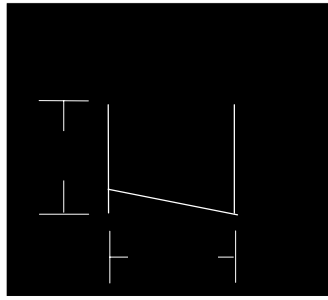
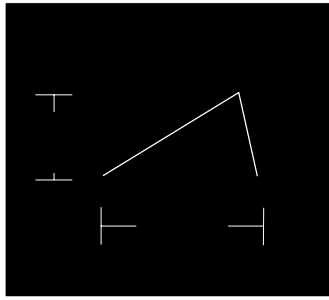

ALIGNMENT SETTINGS

(The figures below are nominal and used for representative purposes only.)

1. Set the Bass to maximum position, set the Treble to minimum position, press the volume down button (-V) on the customer controls at the front of the TV and at the same time press the **INDEX** button on the remote control, this will place the TV into the Service Mode.
2. Press the **RED / GREEN** buttons to step up / down through the functions.
3. Press the **YELLOW / BLUE** buttons to alter the function values.
4. Press the **STR** button after each adjustment has been made to store the required values.
5. To exit the Service Mode, press the **"N"** button.

Alignment Function		Settings / Special features
Horizontal Position	H-Pos 061	Optimum setting.
Vertical Position	V-Pos 005	Optimum setting.
Horizontal Amplitude	H-Amp 055	Optimum setting.
Vert. Amplitude	V-Amp 054	Optimum setting.
EW-amplitude	E/W-Amp1 -128	Optimum setting.
EW-amplitude	E/W-Amp2 006	Optimum setting.
Trapezium-comp	Trapez-1 047	Optimum setting.
Trapezium-comp	Trapez-2 -128	Optimum setting.
Vertical Linearity	V-Lin 006	Optimum setting.
Vertical Symmetry	V-Sym 002	Optimum setting.
DVCO	DVCO -005	Receive a PAL Colour Bar Pattern. For DVCO alignment press " Blue " button, wait until the colours are changing slowly and press " STR ".
Cut-off DC	Cut-off 0171	To adjust Cutoff connect an oscilloscope to the blue cathode. Press " STR " and adjust "cutoff" value using the " Yellow " and " Blue " buttons until the black level is 160V±5V press " STR " to store the value. Remove the oscilloscope. Select Ug2 adjustment and adjust the screen VR until the display shows "O.K."
Ug2 Test	Ug2 055 O.K.	
Highlight Lowlight	High 0902 0777 0864 Low 0117 0132 0112	Optimum setting.
Sub-Brightness	Sub-Brightness 255	Optimum setting.

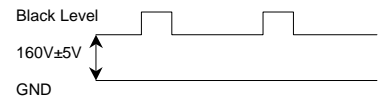

VIDEO BLOCK DIAGRAM

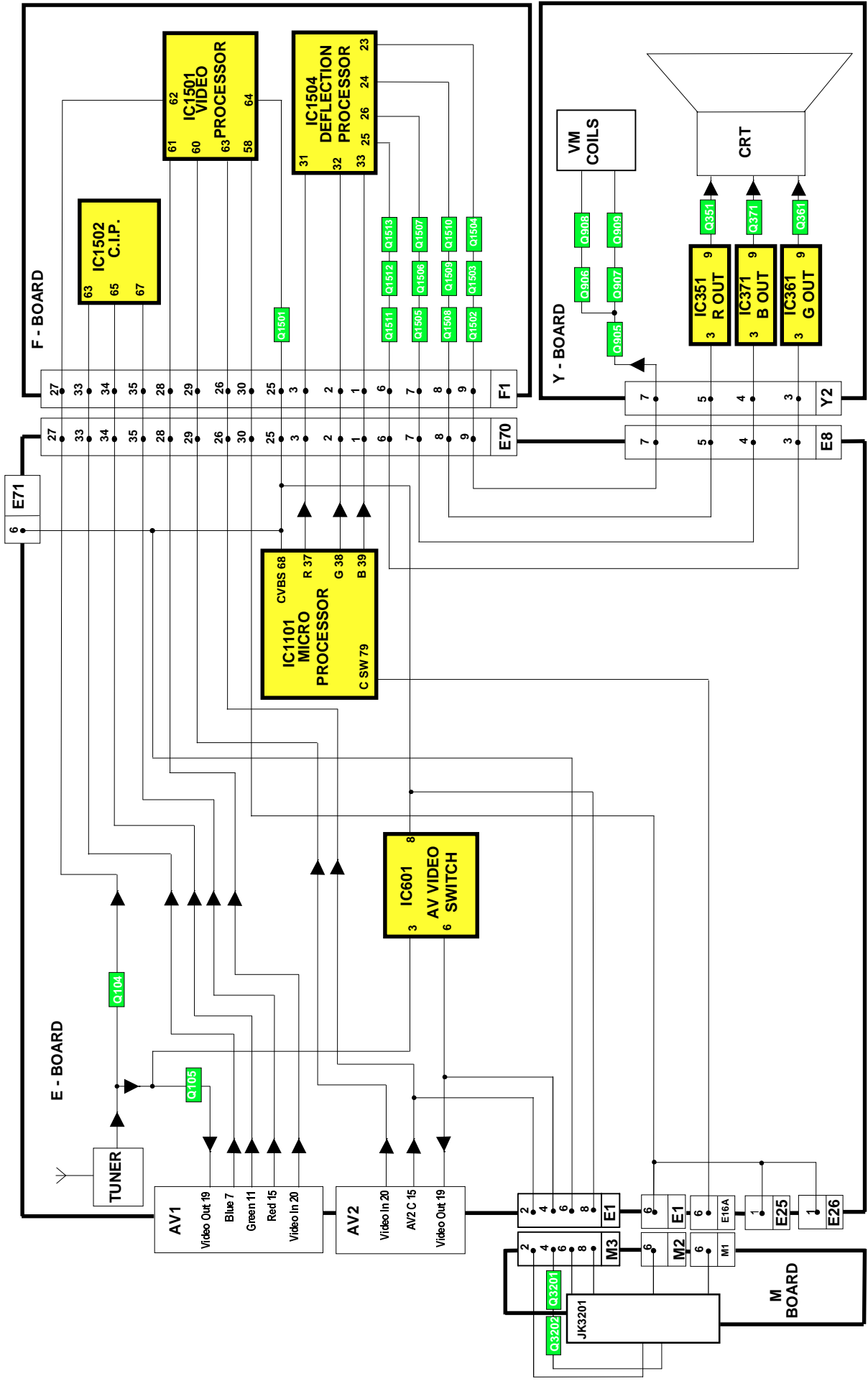

AUDIO BLOCK DIAGRAM

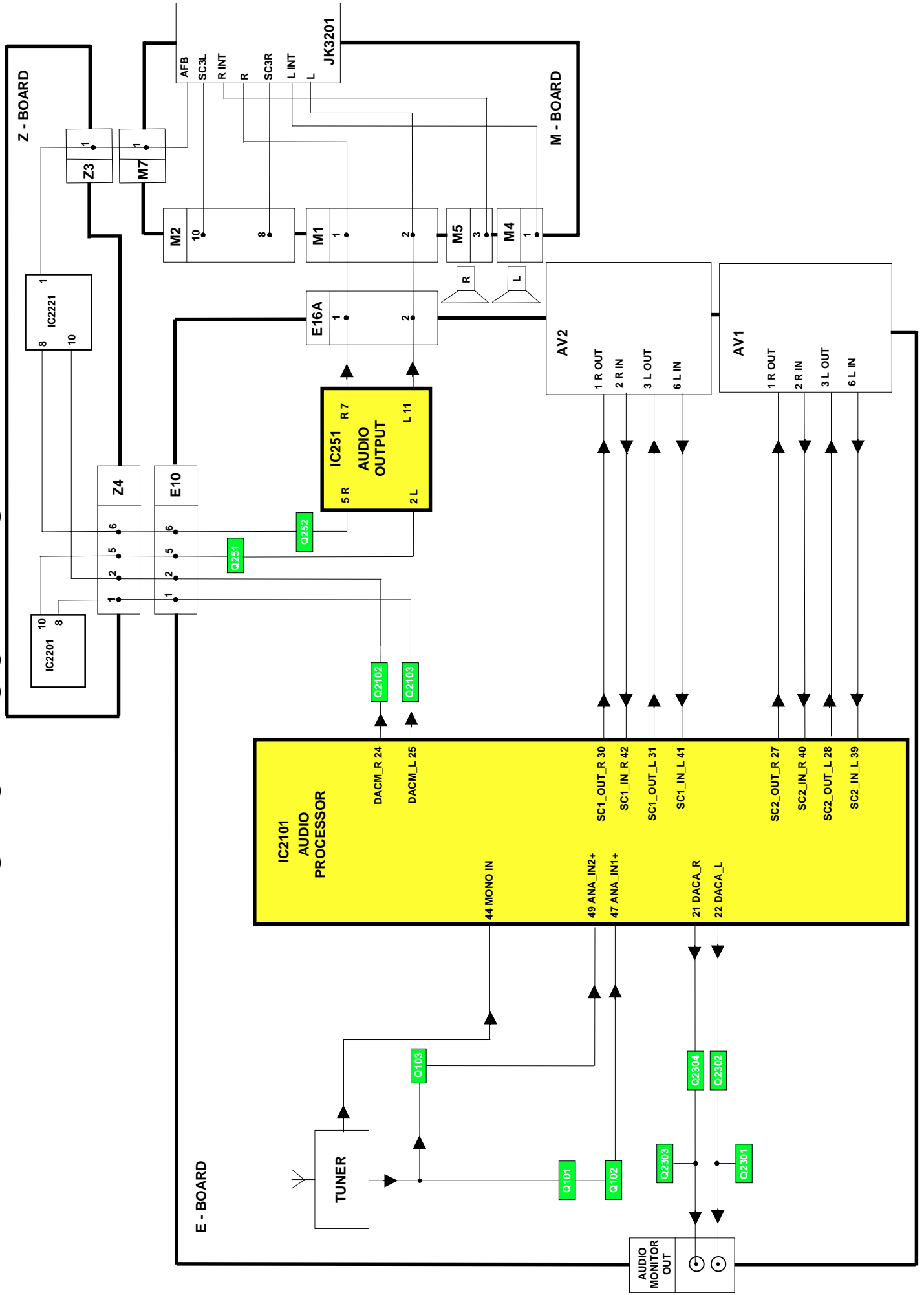

CONTROL BLOCK DIAGRAM

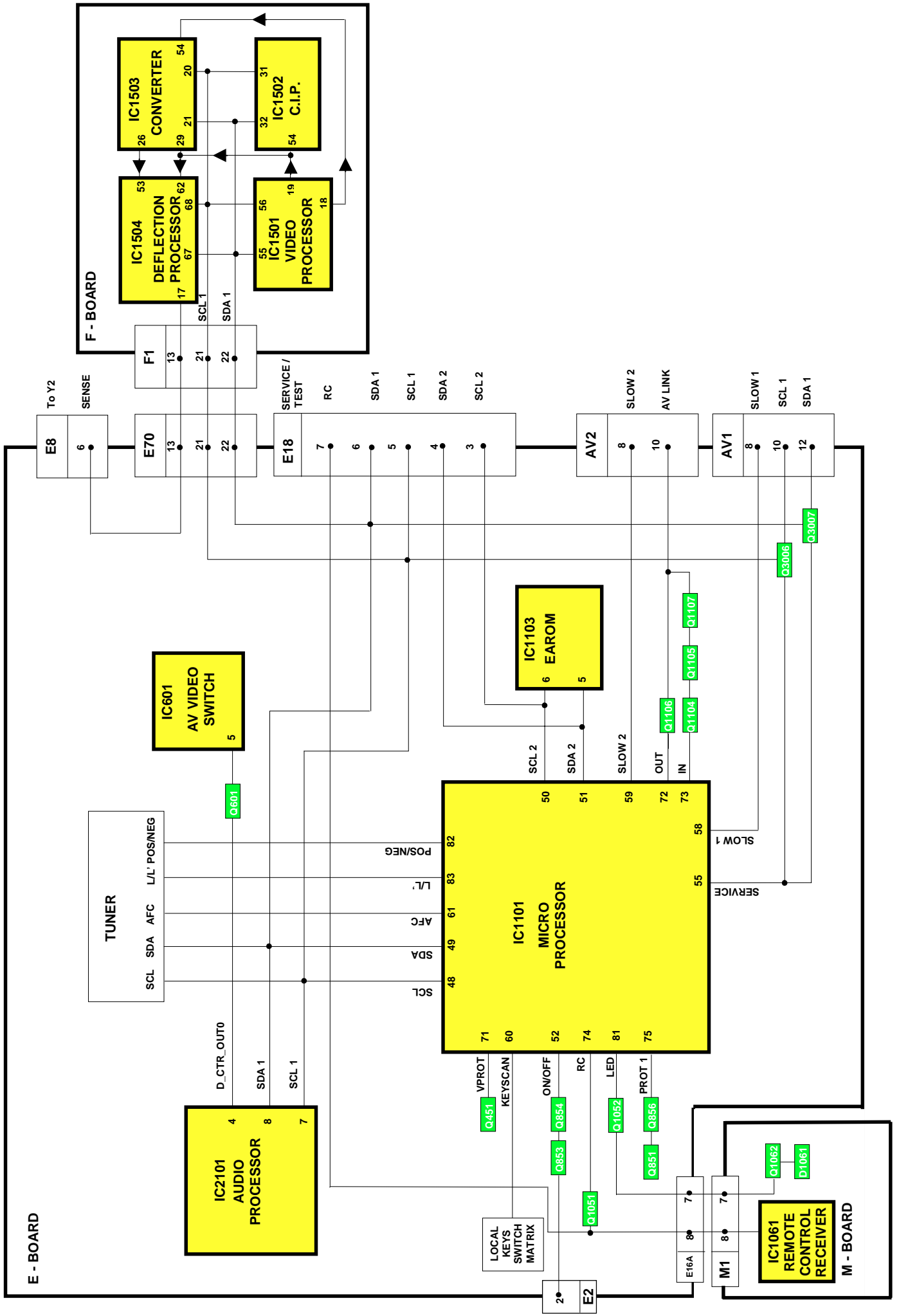

POWER SUPPLY BLOCK DIAGRAM

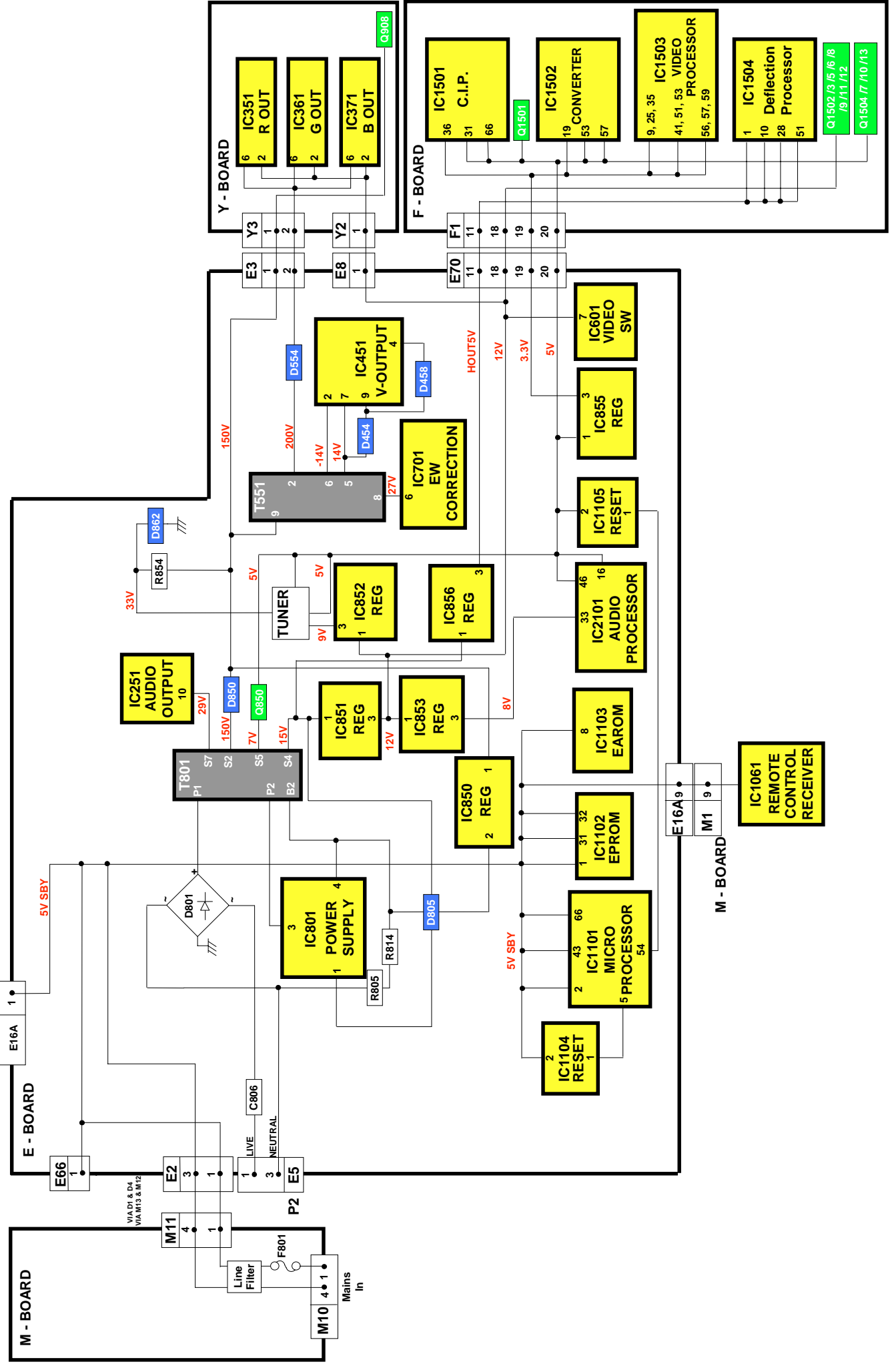

PARTS LOCATION



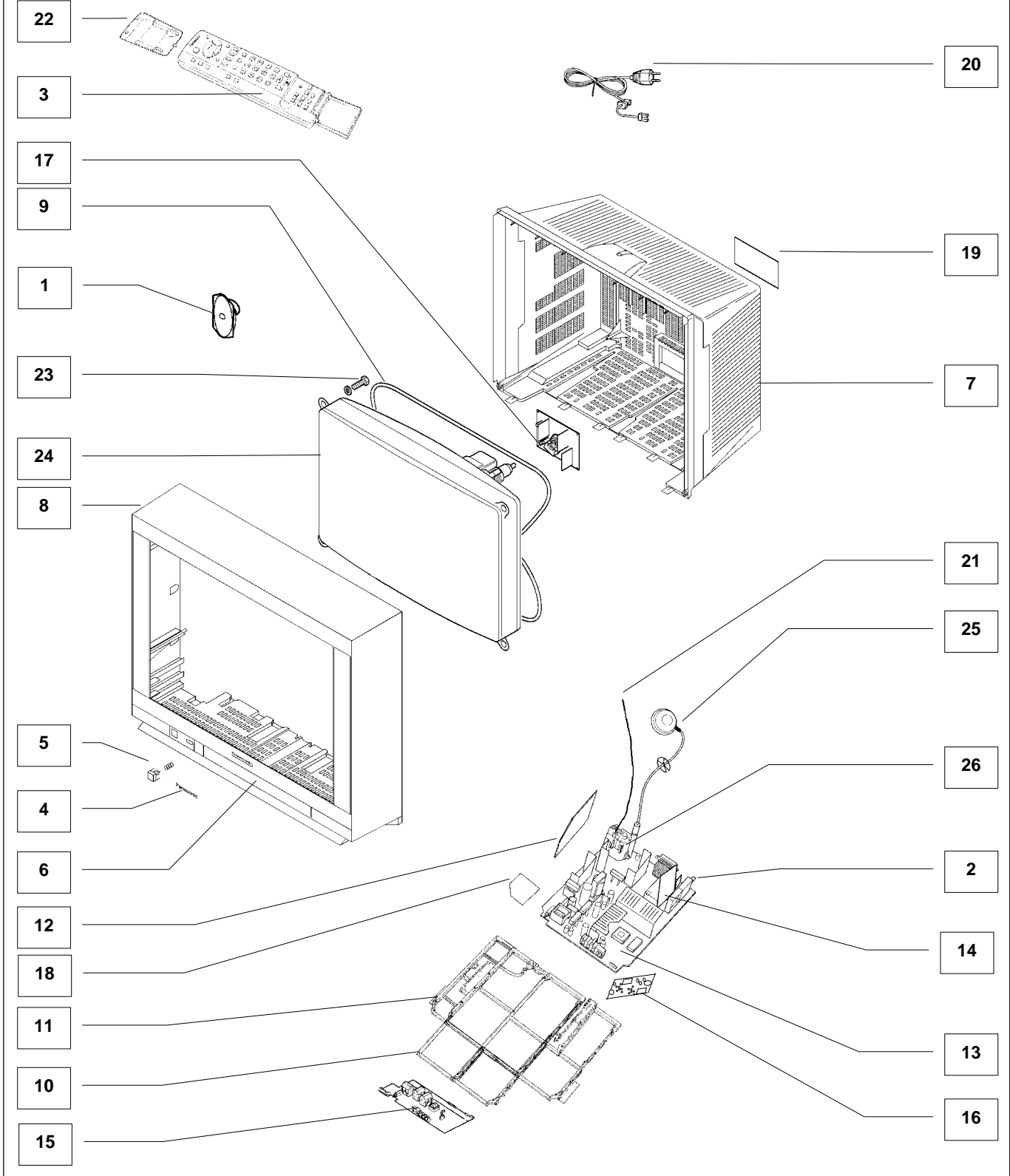















NOTE:
The numbers on the exploded view below refer to the mechanical section of the Replacement Parts List.



REPLACEMENT PARTS LIST

Important Safety Notice

Components Identified by  mark have special characteristics important for safety.
 * When replacing any of these components, use only manufacturers specified parts.
 In case of ordering these spare parts, please always add the complete Model-Type number to your order.

Cct Ref	Parts Number	Description
EXPLODED VIEW		
1	EABG12505A2	SPEAKER
2	ENG27514G	TUNER 
3	EUR511211	REMOTE CONTROL
4	TBMA060	PANASONIC BADGE
5	TBX8E068	POWER BUTTON
6	TKP8E1316	DOOR LID
7	TKU8E00480	BACK COVER 
8	TKY8E390	CABINET 
9	TLK8E05123	DEGAUSS COIL 
10	TMW8E031	CONTROL BRACKET
11	TMX8E037-1	CHASSIS FRAME
12	TNP8ED002AA	D PCB 
13	TNP8EE016AD	E PCB 
14	TNP8EF008AA	F P.C.B. 
15	TNP8EM021BA	M PCB 
16	TNP8EP019AA	P PCB 
17	TNP8EY018AY	Y PCB 
18	TNP8EZ003AB	Z P.C.B. 
19	TQF8E3184	MODEL LABEL 
20	TXASX01BZJG	POWER CORD 
21	TXJ/FC0CJEG	FOCUS LEAD ASSEMBLY 
22	UR51EC904A	BATTERY COVER (REMOTE)
23	VP19151	CRT FIXING SCREW
24	W76EKW10X71	CRT 
25	ZTBZAD550A	ANODE CABLE 
26	ZTFN57005A	FBT 
MISCELLANEOUS COMPONENTS		
.	ERC12GK825	DEGAUSS RESISTOR
.	TBM8E1935	PRESET LABEL
.	TBM8E1936-1	BLANKING LABEL
.	TBM8E1942	AV PANEL LABEL
.	TEK6940	LID CATCH
.	TES2298	CRT EARTH SPRING
.	TES8E021	POWER BUTTON SPRING
.	TKK8E026	SPEAKER REFLECTOR
.	TKP8E1285	SPEAKER NET
.	TKP8E1288	LED COVER
.	TKP8E1300	I.R. COVER
.	TKP8E1301	REAR AV PANEL
.	TKX8E015-A	SPEAKER HORN
.	TMW8E030	LED HOLDER
.	TMX8E035	POWER BUTTON JOINT
.	TPC8E4902	OUTER CARTON
.	TPD8E689	TOP CUSHION
.	TPD8E690	BOTTOM CUSHION
.	TPD8E703	SUB CUSHION
.	UM-3DJ-2P	BATTERY PACK
DEGC	TLK8E05172	ROTATION COIL 
IC1101S	PCSZT-084A-1	IC SOCKET
PCH2	TMW8E052	P PCB BRACKET
VID	VS-PK1/2	VIDEO CABINET

Cct Ref	Parts Number	Description
I.C.s		
IC251	LA4282	AUDIO OUTPUT
IC351	TDA6111Q-N4	RGB OUTPUT
IC361	TDA6111Q-N4	RGB OUTPUT
IC371	TDA6111Q-N4	RGB OUTPUT
IC381	TL431CLPM	REGULATOR
IC451	LA7845N	VERTICAL OUTPUT
IC601	TEA2114	VIDEO SWITCHING
IC701	TEA2031A	E/W CORRECTION
IC801	STRF6656LF57	POWER SUPPLY
IC850	SE140N	ERROR AMPLIFIER
IC851	BA12T-M3	12V REGULATOR
IC853	AN78L08TA	8V REGULATOR
IC855	BA033T-M3	REGULATOR
IC856	AN7805LB	5V REGULATOR
IC1061	RPM6937-V4	LED RECEIVER
IC1101	SDA5450C59	MICRO PROCESSOR
IC1102	27C2001-T01	EAROM *
IC1103	XLM3-03HA	EEPROM *
IC1104	MN1381-R(TA)	RESET
IC1105	MN1381-T(TA)	RESET
IC1502	VPC3230DQAB3	VIDEO PROCESSOR
IC1503	SDA9400	MICRO PROCESSOR
IC1504	DDP3310BPSF5	DOLBY PROCESSOR
IC1900	LA6515	EARTH CORRECTION
IC2101	MSP3410DPOC5	AUDIO PROCESSOR
IC2201	AN6554NSF-E2	OPERATIONAL AMPLIFIER
IC2221	AN6554NSF-E2	OPERATIONAL AMPLIFIER
IC2302	BA15218F-E2	AMPLIFIER
IC3901	AN5422K	DYNAMIC FOCUS
IC3902	AN78M12-LB	12V REGULATOR
FUSES		
F802-1	EYF52BC	FUSE HOLDER
F802-2	EYF52BC	FUSE HOLDER
F802	XBA2C50TH15	FUSE 
DIODES		
D251	MA2180BLFS	DIODE
D253	MA700TA5	DIODE
D254	MA700TA5	DIODE
D351	ERA15-04V3	DIODE
D352	ERA15-04V3	DIODE
D361	ERA15-04V3	DIODE
D362	ERA15-04V3	DIODE
D371	ERA15-04V3	DIODE
D372	ERA15-04V3	DIODE
D376	MA165TA5	DIODE
D377	MA165TA5	DIODE
D378	MA165TA5	DIODE
D387	MA2160LFS	DIODE
D453	MA165TA5	DIODE
D454	EU02	DIODE
D456	MTZJT-775.6C	DIODE

Cct Ref	Parts Number	Description
D457	MA165TA5	DIODE
D501	MA165TA5	DIODE
D502	1SR124-4AT82	DIODE
D511	MTZJ4.7C	DIODE
D553	1SR124-4AT82	DIODE
D554	1SR124-4AT82	DIODE
D556	MA165TA5	DIODE
D557	TVSRU2AMLFA5	DIODE
D558	EU02	DIODE
D560	RH3GLF102	DIODE
D561	UDZSTE-1722B	DIODE
D562	1SS355TE-17	DIODE
D580	FMV-3GULF730	DIODE
D602	MTZJT-775.1B	DIODE
D603	MA165TA5	DIODE
D604	MA165TA5	DIODE
D609	1SR124-4AT82	DIODE
D617	MA3068MTX	DIODE
D620	MA165TA5	DIODE
D701	MA165TA5	DIODE
D702	MTZJT-775.6B	DIODE
D704	MA29TA5	DIODE
D705	MTZJT-777.5A	DIODE
D706	MA165TA5	DIODE
D707	AU02V0	DIODE
D708	MA165TA5	DIODE
D709	MA1033MTA	DIODE
D710	MTZJT-7716C	DIODE
D801	RBV-608LF-B	DIODE
D802	232266296706	THERMISTOR
D803	1SR124-4AT82	DIODE
D804	1SR124-4AT82	DIODE
D805	TLP621GR-LF2	PHOTO COUPLER
D806	1SR124-4AT82	DIODE
D807	MTZJT-7712C	DIODE
D808	232266296706	THERMISTOR
D850	RU4BLF-L1	DIODE
D851	MTZJT776.2B	DIODE
D852	MA165TA5	DIODE
D853	MA2180BLFS	DIODE
D854	S3L20U04P15	DIODE
D855	D10SC6MRL	DIODE
D856	RU4AMLF-M1	DIODE
D857	MTZJT-775.1A	DIODE
D858	MA165TA5	DIODE
D859	MA165TA5	DIODE
D861	MA165TA5	DIODE
D862	MTZJT-7736A	DIODE
D863	MA165TA5	DIODE
D865	MA165TA5	DIODE
D866	MA165TA5	DIODE
D867	EK06-V0	DIODE
D868	1N4150T-77	DIODE
D869	1N4150T-77	DIODE
D871	1N4150T-77	DIODE
D873	MTZJT-775.6C	DIODE
D874	1SR124-4AT82	DIODE
D875	BZX79A75A26A	DIODE
D890	MA165TA5	DIODE
D891	MA165TA5	DIODE
D901	MA165TA5	DIODE
D902	MA165TA5	DIODE
D903	MA165TA5	DIODE
D907	MA165TA5	DIODE
D910	R2KNLFA1	DIODE
D1061	LN81RPHCF3	LED

Cct Ref	Parts Number	Description
D1101	MA165TA5	DIODE
D1104	MA165TA5	DIODE
D1105	MA165TA5	DIODE
D1131	MTZJT-775.6C	DIODE
D2101	MA723TA5	DIODE
D2102	MA723TA5	DIODE
D2103	MA723TA5	DIODE
D2104	MA723TA5	DIODE
D2105	MTZJT-778.2C	DIODE
D2303	MA723TA5	DIODE
D2304	MA723TA5	DIODE
D3201	MTZJT-778.2C	DIODE
D3202	MTZJT-778.2C	DIODE
D3351	MA165TA5	DIODE
D3352	MA165TA5	DIODE
D3353	MA165TA5	DIODE
D3354	MA165TA5	DIODE
D3901	MTZJT-779.1C	DIODE
D3906	MA165TA5	DIODE
D3907	ERA22-06V3	DIODE
D3908	ERA22-06V3	DIODE
D3909	MA165TA5	DIODE
D3910	RP1HLFA5	DIODE
D3911	RP1HLFA5	DIODE
D3912	MA165TA5	DIODE
D3915	MTZJT-7710D	DIODE
D3917	MA165TA5	DIODE
D3920	MA165TA5	DIODE
TRANSISTORS		
Q101	BC847B	TRANSISTOR
Q102	BC847B	TRANSISTOR
Q104	BC847B	TRANSISTOR
Q105	BC847B	TRANSISTOR
Q251	2SD1328STX	TRANSISTOR
Q252	2SD1328STX	TRANSISTOR
Q253	BC847B	TRANSISTOR
Q254	BC847B	TRANSISTOR
Q351	2SA1767	TRANSISTOR
Q361	2SA1767	TRANSISTOR
Q371	2SA1767	TRANSISTOR
Q451	BC857B	TRANSISTOR
Q503	2SK2962TPE6	TRANSISTOR
Q551	2SC5144LB228	TRANSISTOR
Q552	2SC1473ATA	TRANSISTOR
Q553	BC847B	TRANSISTOR
Q601	BC847B	TRANSISTOR
Q701	BC857B	TRANSISTOR
Q702	BC847B	TRANSISTOR
Q703	IRF644R-M3S	TRANSISTOR
Q850	2SD2396K-M3	TRANSISTOR
Q851	BC857B	TRANSISTOR
Q852	2SD1858TV2	TRANSISTOR
Q853	BC847B	TRANSISTOR
Q854	BC847B	TRANSISTOR
Q855	BC847B	TRANSISTOR
Q856	BC847B	TRANSISTOR
Q857	2SA1018QTA	TRANSISTOR
Q905	BC847B	TRANSISTOR
Q906	BC847B	TRANSISTOR
Q907	BC857B	TRANSISTOR
Q908	2SA1535ARLB	TRANSISTOR
Q909	2SC3944ARLB	TRANSISTOR
Q1051	BC847B	TRANSISTOR
Q1062	BC847B	TRANSISTOR
Q1104	BC847B	TRANSISTOR
Q1105	BC847B	TRANSISTOR

Cct Ref	Parts Number	Description
Q1106	BC847B	TRANSISTOR
Q1107	BC847B	TRANSISTOR
Q1108	BC847B	TRANSISTOR
Q1501	BC847B	TRANSISTOR
Q1502	BC857B	TRANSISTOR
Q1503	BC847B	TRANSISTOR
Q1504	BC847B	TRANSISTOR
Q1505	BC857B	TRANSISTOR
Q1506	BC847B	TRANSISTOR
Q1507	BC847B	TRANSISTOR
Q1508	BC857B	TRANSISTOR
Q1509	BC847B	TRANSISTOR
Q1510	BC847B	TRANSISTOR
Q1511	BC857B	TRANSISTOR
Q1512	BC847B	TRANSISTOR
Q1513	BC847B	TRANSISTOR
Q1514	BC847B	TRANSISTOR
Q1515	BC847B	TRANSISTOR
Q1900	BC847B	TRANSISTOR
Q2101	BC857B	TRANSISTOR
Q2102	BC857B	TRANSISTOR
Q2103	BC857B	TRANSISTOR
Q2201	BC847B	TRANSISTOR
Q2202	BC847B	TRANSISTOR
Q2301	BC847B	TRANSISTOR
Q2302	BC857B	TRANSISTOR
Q2303	BC847B	TRANSISTOR
Q2304	BC857B	TRANSISTOR
Q3006	BC847B	TRANSISTOR
Q3007	BC847B	TRANSISTOR
Q3201	BC847B	TRANSISTOR
Q3202	BC847B	TRANSISTOR
Q3203	BC857B	TRANSISTOR
Q3204	BC857B	TRANSISTOR
Q3205	BC847B	TRANSISTOR
Q3206	BC847B	TRANSISTOR
Q3207	BC847B	TRANSISTOR
Q3208	BC847B	TRANSISTOR
Q3209	BC847B	TRANSISTOR
Q3352	BC857B	TRANSISTOR
Q3901	BC847B	TRANSISTOR
Q3902	BC847B	TRANSISTOR
Q3903	BC847B	TRANSISTOR
Q3904	BC857B	TRANSISTOR
Q3905	2SK1006RF122	TRANSISTOR
Q3906	2SC4572RB	TRANSISTOR
Q3907	BC847B	TRANSISTOR
Q3908	BC847B	TRANSISTOR
Q3911	BC847B	TRANSISTOR
Q3912	BC847B	TRANSISTOR
Q3917	BC847B	TRANSISTOR
TRANSFORMERS		
T501	ETH19Y193AY	TRANSFORMER
T801	10711520	TRANSFORMER
T803	ETP35KAN619U	TRANSFORMER
T3901	ETF18L37B	TRANSFORMER
COILS		
J26	EXCELD35V	COIL
J212	EXCELSA35V	COIL
JA11	ELJFC2R2KF	COIL
L104	EXCELSA35T	COIL
L106	TLTACT100K	COIL
L107	TLTACT6R8K	COIL
L301	TLTACT4R7K	COIL
L381	TLT220K991R	COIL
L382	ELESN6R8KA	COIL

△
△
△
△

Cct Ref	Parts Number	Description
L451	EXCELSA35T	COIL
L501	EXCELSA35T	COIL
L563	EXCELD35C	COIL
L581	ELHKLBO61B	COIL
L582	ELC18B221L	COIL
L584	ELH5L7701	LINEARITY COIL
L606	ELESN100KA	COIL
L701	ELC18B271E	COIL
L704	ELC10D332E	COIL
L705	EXCELD35V	COIL
L810	ETQR42T005A	COIL
L850	EXCELSA35T	COIL
L851	EXCELSA35T	COIL
L852	ELEIE470KA	COIL
L855	EXCELSA35T	COIL
L856	EXCELSA39V	COIL
L910	EXCELSA35T	COIL
L911	EXCELSA35T	COIL
L912	EXCELSA35T	COIL
L1061	TLT331K991R	COIL
L1103	TLTACT100K	COIL
L1104	EXCELSA35T	COIL
L1105	ELJFC2R2KF	COIL
L1501	ELESN2R2KA	COIL
L1502	ELESN2R2KA	COIL
L1503	ELESN2R2KA	COIL
L1504	ELESN2R2KA	COIL
L1505	ELESN100KA	COIL
L1506	ELESN100KA	COIL
L1510	ELESN100KA	COIL
L1514	ELESN100KA	COIL
L1515	ELESNR39KA	COIL
L1518	ELESN4R7KA	COIL
L1519	ELESNR39KA	COIL
L1520	ELESN2R2KA	COIL
L1521	ELESN1R0KA	COIL
L1522	ELESN3R3KA	COIL
L1523	ELESN3R3KA	COIL
L1524	ELESN3R3KA	COIL
L1526	ELESN100KA	COIL
L1527	ELESN100KA	COIL
L1528	ELESN100KA	COIL
L1529	ELESN100KA	COIL
L1601	ELESN3R3KA	COIL
L1900	EXCELD35V	COIL
L2101	TLTACT100K	COIL
L2103	EXCELSA35T	COIL
L2104	TLTACT4R7K	COIL
L2202	ELESN2R2KA	COIL
L2222	ELESN2R2KA	COIL
L3001	ELEMV1R5MA	COIL
L3002	ELEMV1R5MA	COIL
L3003	ELEMV1R5MA	COIL
L3004	ELEMV1R5MA	COIL
L3201	ELEBR6R8KA	COIL
L3202	ELEBR6R8KA	COIL
L3204	TLT331K991R	COIL
L3902	ELC08D182E	COIL
FILTERS		
L1901	ELF18N012A	LINE FILTER
CRYSTALS		
X1101	TSSA121	CRYSTAL
X1501	4730007267	CRYSTAL
X1502	4730007341	CRYSTAL
X2101	4730007158	CRYSTAL

Cct Ref	Parts Number	Description				
RESISTORS						
C101	ERJ6GEY0R00	S.M.CARB	0.1W	5%	0 Ω	
C510	ERJ6GEY0R00	S.M.CARB	0.1W	5%	0 Ω	
C2214	ERJ6GEY0R00	S.M.CARB	0.1W	5%	0 Ω	
C2234	ERJ6GEY0R00	S.M.CARB	0.1W	5%	0 Ω	
JA1	ERJ6GEY0R00	S.M.CARB	0.1W	5%	0 Ω	
JA2	ERJ6GEY0R00	S.M.CARB	0.1W	5%	0 Ω	
JA3	ERJ6GEY0R00	S.M.CARB	0.1W	5%	0 Ω	
JA4	ERJ6GEY0R00	S.M.CARB	0.1W	5%	0 Ω	
JA5	ERJ6GEY0R00	S.M.CARB	0.1W	5%	0 Ω	
JA6	ERJ6GEY0R00	S.M.CARB	0.1W	5%	0 Ω	
JA7	ERJ6GEY0R00	S.M.CARB	0.1W	5%	0 Ω	
JA8	ERJ6GEY0R00	S.M.CARB	0.1W	5%	0 Ω	
JA9	ERJ6GEY0R00	S.M.CARB	0.1W	5%	0 Ω	
JA10	ERJ6GEY0R00	S.M.CARB	0.1W	5%	0 Ω	
JA10	ERJ8GEY0R00	S.M.CARB	.125W	5%	0 Ω	
JA12	ERJ6GEY0R00	S.M.CARB	0.1W	5%	0 Ω	
JA12	ERJ8GEY0R00	S.M.CARB	.125W	5%	0 Ω	
JA13	ERJ6GEY0R00	S.M.CARB	0.1W	5%	0 Ω	
JA13	ERJ8GEY0R00	S.M.CARB	.125W	5%	0 Ω	
JA14	ERJ6GEY0R00	S.M.CARB	0.1W	5%	0 Ω	
JA15	ERJ6GEY0R00	S.M.CARB	0.1W	5%	0 Ω	
JA16	ERJ6GEY0R00	S.M.CARB	0.1W	5%	0 Ω	
JA17	ERJ6GEY0R00	S.M.CARB	0.1W	5%	0 Ω	
JA18	ERJ6GEY0R00	S.M.CARB	0.1W	5%	0 Ω	
JA18	ERJ8GEY0R00	S.M.CARB	.125W	5%	0 Ω	
JA19	ERJ6GEY0R00	S.M.CARB	0.1W	5%	0 Ω	
JA19	ERJ8GEY0R00	S.M.CARB	.125W	5%	0 Ω	
JA20	ERJ6GEY0R00	S.M.CARB	0.1W	5%	0 Ω	
JA20	ERJ8GEY0R00	S.M.CARB	.125W	5%	0 Ω	
JA21	ERJ6GEY0R00	S.M.CARB	0.1W	5%	0 Ω	
JA101	ERJ8GEY0R00	S.M.CARB	.125W	5%	0 Ω	
JA102	ERJ8GEY0R00	S.M.CARB	.125W	5%	0 Ω	
JA103	ERJ8GEY0R00	S.M.CARB	.125W	5%	0 Ω	
JA104	ERJ8GEY0R00	S.M.CARB	.125W	5%	0 Ω	
JA105	ERJ8GEY0R00	S.M.CARB	.125W	5%	0 Ω	
JA106	ERJ8GEY0R00	S.M.CARB	.125W	5%	0 Ω	
JA107	ERJ8GEY0R00	S.M.CARB	.125W	5%	0 Ω	
JA108	ERJ8GEY0R00	S.M.CARB	.125W	5%	0 Ω	
JA109	ERJ8GEY0R00	S.M.CARB	.125W	5%	0 Ω	
JA110	ERJ8GEY0R00	S.M.CARB	.125W	5%	0 Ω	
JA111	ERJ8GEY0R00	S.M.CARB	.125W	5%	0 Ω	
JA112	ERJ8GEY0R00	S.M.CARB	.125W	5%	0 Ω	
JA113	ERJ8GEY0R00	S.M.CARB	.125W	5%	0 Ω	
JA114	ERJ8GEY0R00	S.M.CARB	.125W	5%	0 Ω	
JA115	ERJ8GEY0R00	S.M.CARB	.125W	5%	0 Ω	
JA116	ERJ8GEY0R00	S.M.CARB	.125W	5%	0 Ω	
JA117	ERJ8GEY0R00	S.M.CARB	.125W	5%	0 Ω	
JA118	ERJ8GEY0R00	S.M.CARB	.125W	5%	0 Ω	
JA119	ERJ8GEY0R00	S.M.CARB	.125W	5%	0 Ω	
JA120	ERJ8GEY0R00	S.M.CARB	.125W	5%	0 Ω	
JSE10	ERJ6GEY0R00	S.M.CARB	0.1W	5%	0 Ω	
JSE12	ERJ6GEY0R00	S.M.CARB	0.1W	5%	0 Ω	
JSE18	ERJ6GEY0R00	S.M.CARB	0.1W	5%	0 Ω	
JSE22	ERJ6GEY0R00	S.M.CARB	0.1W	5%	0 Ω	
JSE26	ERJ6GEY0R00	S.M.CARB	0.1W	5%	0 Ω	
JSE33	ERJ6GEY0R00	S.M.CARB	0.1W	5%	0 Ω	
JSE35	ERJ6GEY0R00	S.M.CARB	0.1W	5%	0 Ω	
JSE42	ERJ6GEY0R00	S.M.CARB	0.1W	5%	0 Ω	
JSE43	ERJ6GEY0R00	S.M.CARB	0.1W	5%	0 Ω	
JSM7	ERJ6GEY0R00	S.M.CARB	0.1W	5%	0 Ω	
JSM8	ERJ6GEY0R00	S.M.CARB	0.1W	5%	0 Ω	
JSM10	ERJ6GEY0R00	S.M.CARB	0.1W	5%	0 Ω	
JSP15	ERJ6GEY0R00	S.M.CARB	0.1W	5%	0 Ω	
JSY04	ERJ6GEY0R00	S.M.CARB	0.1W	5%	0 Ω	
L114	ERJ6GEYJ331	S.M.CARB	0.1W	5%	330 Ω	

Cct Ref	Parts Number	Description				
L115	ERJ6GEYJ331	S.M.CARB	0.1W	5%	330 Ω	
L1507	ERJ8GEY0R00	S.M.CARB	.125W	5%	0 Ω	
L1508	ERJ8GEY0R00	S.M.CARB	.125W	5%	0 Ω	
L1509	ERJ8GEY0R00	S.M.CARB	.125W	5%	0 Ω	
R101	ERJ6GEY0R00	S.M.CARB	0.1W	5%	0 Ω	
R102	ERJ6GEYJ103	S.M.CARB	0.1W	5%	10K Ω	
R103	ERJ6GEYJ222	S.M.CARB	0.1W	5%	2K2 Ω	
R104	ERJ6GEYJ332	S.M.CARB	0.1W	5%	3K3 Ω	
R105	ERJ6GEYJ101	S.M.CARB	0.1W	5%	100 Ω	
R106	ERJ6GEYJ681	S.M.CARB	0.1W	5%	680 Ω	
R107	ERJ6GEYJ102	S.M.CARB	0.1W	5%	1K Ω	
R111	ERJ6GEY0R00	S.M.CARB	0.1W	5%	0 Ω	
R112	ERJ6GEYJ101	S.M.CARB	0.1W	5%	100 Ω	
R113	ERJ6GEYJ223	S.M.CARB	0.1W	5%	22K Ω	
R116	ERJ6GEYJ562	S.M.CARB	0.1W	5%	5K6 Ω	
R117	ERJ6GEYJ222	S.M.CARB	0.1W	5%	2K2 Ω	
R118	ERJ6GEYJ102	S.M.CARB	0.1W	5%	1K Ω	
R121	ERJ6GEYJ471	S.M.CARB	0.1W	5%	470 Ω	
R251	ERJ6GEYJ820	S.M.CARB	0.1W	5%	82 Ω	
R252	ERJ6GEYJ751	S.M.CARB	0.1W	5%	750 Ω	
R253	ERJ6GEYJ103	S.M.CARB	0.1W	5%	10K Ω	
R254	ERJ6GEYJ820	S.M.CARB	0.1W	5%	82 Ω	
R255	ERJ6GEYJ103	S.M.CARB	0.1W	5%	10K Ω	
R256	ERJ6GEYJ471	S.M.CARB	0.1W	5%	470 Ω	
R257	ERJ6GEYJ180	S.M.CARB	0.1W	5%	18 Ω	
R258	ERJ6GEYJ751	S.M.CARB	0.1W	5%	750 Ω	
R259	ERJ6GEYJ180	S.M.CARB	0.1W	5%	18 Ω	
R260	ERJ6GEYJ103	S.M.CARB	0.1W	5%	10K Ω	
R261	ERJ6GEYJ471	S.M.CARB	0.1W	5%	470 Ω	
R262	ERJ6GEYJ103	S.M.CARB	0.1W	5%	10K Ω	
R263	ERJ6GEYJ473	S.M.CARB	0.1W	5%	47K Ω	
R264	ERJ6GEYJ103	S.M.CARB	0.1W	5%	10K Ω	
R265	ERD25TJ2R2	CARBON	0.25W	5%	2R2 Ω	
R266	ERD25TJ2R2	CARBON	0.25W	5%	2R2 Ω	
R267	ERF7ZK4R7	WOUND	7W	10%	4R7 Ω	⚠
R268	ERJ6GEYJ103	S.M.CARB	0.1W	5%	10K Ω	
R269	ERQ14AJ101	METAL	0.25W	5%	100 Ω	⚠
R271	ERJ6GEYJ103	S.M.CARB	0.1W	5%	10K Ω	
R272	ERF7ZK4R7	WOUND	7W	10%	4R7 Ω	⚠
R350	ERQ12AJ151P	FUSIBLE	0.5W	5%	150 Ω	⚠
R352	ERJ6GEYJ202	S.M.CARB	0.1W	5%	2K Ω	
R355	ERG1ANJP683H	METAL	0.5W	5%	68K Ω	
R356	ERJ6GEYJ181	S.M.CARB	0.1W	5%	180 Ω	
R358	ERDS1TJ821	CARBON	0.5W	5%	820 Ω	
R360	ERO50PKF8251	METAL	0.5W	5%	8M2 Ω	⚠
R362	ERJ6GEYJ202	S.M.CARB	0.1W	5%	2K Ω	
R365	ERG1ANJP683H	METAL	0.5W	5%	68K Ω	
R366	ERJ6GEYJ181	S.M.CARB	0.1W	5%	180 Ω	
R368	ERDS1TJ821	CARBON	0.5W	5%	820 Ω	
R370	ERQ1CJP1R2	FUSIBLE	1W	5%	1R2 Ω	
R372	ERJ6GEYJ202	S.M.CARB	0.1W	5%	2K Ω	
R375	ERG1ANJP683H	METAL	0.5W	5%	68K Ω	
R376	ERJ6GEYJ181	S.M.CARB	0.1W	5%	180 Ω	
R378	ERDS1TJ821	CARBON	0.5W	5%	820 Ω	
R382	ERJ6GEY0R00	S.M.CARB	0.1W	5%	0 Ω	
R383	ERJ6GEY0R00	S.M.CARB	0.1W	5%	0 Ω	
R394	ERJ6GEYJ821	S.M.CARB	0.1W	5%	820 Ω	
R396	ERJ6GEYJ821	S.M.CARB	0.1W	5%	820 Ω	
R398	ERJ6GEYJ821	S.M.CARB	0.1W	5%	820 Ω	
R451	ERJ6GEYJ223	S.M.CARB	0.1W	5%	22K Ω	
R452	ERJ6GEY0R00	S.M.CARB	0.1W	5%	0 Ω	
R453	ERJ6GEY0R00	S.M.CARB	0.1W	5%	0 Ω	
R454	ERJ6GEYJ393	S.M.CARB	0.1W	5%	39K Ω	
R455	ERJ6GEYJ223	S.M.CARB	0.1W	5%	22K Ω	
R456	ERJ6GEYJ104	S.M.CARB	0.1W	5%	100K Ω	
R457	ERJ6GEYJ223	S.M.CARB	0.1W	5%	22K Ω	

Cct Ref	Parts Number	Description			
R458	ERDS1TJ1R0	CARBON	0.5W	5%	1 Ω
R459	ERJ6GEYJ101	S.M.CARB	0.1W	5%	100 Ω
R461	ERX2SJS1R5H	FUSIBLE	2W	5%	1R5 Ω
R463	ERDS2TJ222T	CARBON	0.5W	5%	2K2 Ω
R464	ERJ6GEYJ682	S.M.CARB	0.1W	5%	6K8 Ω
R465	ERJ6GEYJ102	S.M.CARB	0.1W	5%	1K Ω
R467	ERJ6GEY0R00	S.M.CARB	0.1W	5%	0 Ω
R468	ERG3SJS151	METAL	3W	5%	150 Ω
R502	ERJ6GEY0R00	S.M.CARB	0.1W	5%	0 Ω
R503	ERJ6GEYJ332	S.M.CARB	0.1W	5%	3K3 Ω
R507	ERG3SJS120	METAL	3W	5%	12 Ω ▲
R509	ERG2SJW222E	METAL	2W	5%	2K2 Ω
R510	ERG2SJW222E	METAL	2W	5%	2K2 Ω
R551	ERX3SJSR22	METAL	3W	5%	R22 Ω ▲
R555	ERQ12HKR82	FUSIBLE	0.5W	10%	R82 Ω ▲
R558	ERDS1TJ124	CARBON	0.5W	5%	120K Ω
R559	ERQ12HKR82	FUSIBLE	0.5W	10%	R82 Ω ▲
R560	ERJ6GEYJ274	S.M.CARB	0.1W	5%	270K Ω
R561	ERJ6GEYJ223	S.M.CARB	0.1W	5%	22K Ω
R563	ERJ6GEYJ224	S.M.CARB	0.1W	5%	220K Ω
R564	ERJ6GEYJ333	S.M.CARB	0.1W	5%	33K Ω
R566	ERJ6GEYJ563	S.M.CARB	0.1W	5%	56K Ω
R567	ERF7ZK2R2	WOUND	7W	10%	2R2 Ω
R568	ERDS1TJ120	CARBON	0.5W	5%	12 Ω
R569	ERJ6GEYJ102	S.M.CARB	0.1W	5%	1K Ω
R571	ERJ6GEYJ104	S.M.CARB	0.1W	5%	100K Ω
R572	ERJ6GEYJ102	S.M.CARB	0.1W	5%	1K Ω
R573	ERJ6GEYJ101	S.M.CARB	0.1W	5%	100 Ω
R581	ERG3FJ331	METAL	3W	5%	330 Ω ▲
R583	ERG3FJ821	METAL	3W	5%	820 Ω ▲
R603	ERJ6GEYJ223	S.M.CARB	0.1W	5%	22K Ω
R604	ERJ6GEYJ101	S.M.CARB	0.1W	5%	100 Ω
R605	ERJ6GEYJ101	S.M.CARB	0.1W	5%	100 Ω
R606	ERJ6GEYJ472	S.M.CARB	0.1W	5%	4K7 Ω
R607	ERJ6GEY0R00	S.M.CARB	0.1W	5%	0 Ω
R608	ERJ6GEYJ201	S.M.CARB	0.1W	5%	200 Ω
R609	ERJ6GEYJ201	S.M.CARB	0.1W	5%	200 Ω
R610	ERJ6GEYJ242	S.M.CARB	0.1W	5%	2K4 Ω
R611	ERJ6GEYJ104	S.M.CARB	0.1W	5%	100K Ω
R612	ERJ6GEYJ101	S.M.CARB	0.1W	5%	100 Ω
R620	ERJ6GEYJ103	S.M.CARB	0.1W	5%	10K Ω
R622	ERJ6GEY0R00	S.M.CARB	0.1W	5%	0 Ω
R647	ERJ6GEYJ101	S.M.CARB	0.1W	5%	100 Ω
R648	ERJ6GEYJ332	S.M.CARB	0.1W	5%	3K3 Ω
R650	ERJ6GEYJ750	S.M.CARB	0.1W	5%	75 Ω
R701	ERQ12AJ330P	METAL	0.5W	5%	330 Ω ▲
R702	ERX2SJS2R7	FUSIBLE	2W	5%	2R7 Ω
R703	ERG2FJ821	METAL	2W	5%	820 Ω ▲
R704	ERJ6GEYJ563	S.M.CARB	0.1W	5%	56K Ω
R705	ERJ6GEYJ183	S.M.CARB	0.1W	5%	18K Ω
R706	ERJ6GEYJ103	S.M.CARB	0.1W	5%	10K Ω
R707	ERJ6GEYJ391	S.M.CARB	0.1W	5%	390 Ω
R708	ERJ6GEYJ393	S.M.CARB	0.1W	5%	39K Ω
R709	ERJ6GEYJ393	S.M.CARB	0.1W	5%	39K Ω
R710	ERJ6GEYJ273	S.M.CARB	0.1W	5%	27K Ω
R711	ERG1SJ101	METAL	1W	5%	100 Ω
R712	ERJ6GEYJ102	S.M.CARB	0.1W	5%	1K Ω
R714	ERJ6GEYJ222	S.M.CARB	0.1W	5%	2K2 Ω
R715	ERD25TJ272F	CARBON	0.25W	5%	2K7 Ω
R716	ERQ12AJ680P	METAL	0.5W	5%	68 Ω ▲
R718	ERJ6GEYJ102	S.M.CARB	0.1W	5%	1K Ω
R719	ERJ6GEYJ274	S.M.CARB	0.1W	5%	270K Ω
R802	ERC12ZGK335D	SOLID	0.5W	10%	3M3 Ω ▲
R805	ERD25TJ473	CARBON	0.25W	5%	47K Ω
R806	ERD25TJ100	CARBON	0.25W	5%	10 Ω
R807	ERD25TJ332	CARBON	0.25W	5%	3K3 Ω

Cct Ref	Parts Number	Description			
R809	ERD25TJ681	CARBON	0.25W	5%	680 Ω
R810	ERW2PKR22	WOUND	2W	5%	22 Ω
R811	ERW2PKR22	WOUND	2W	5%	22 Ω
R812	ERD75TAJ825	CARBON	0.75W	5%	8M2 Ω ▲
R813	ERF10ZK2R7	WOUND	10W	5%	2.7 Ω
R814	ERD25TJ473	CARBON	0.25W	5%	47K Ω
R815	ERD25TJ222	CARBON	0.25W	5%	2K2 Ω
R850	ERD25TJ122	CARBON	0.25W	5%	1K2 Ω
R852	ERJ6GEY0R00	S.M.CARB	0.1W	5%	0 Ω
R853	ERJ6GEYJ102	S.M.CARB	0.1W	5%	1K Ω
R854	ERG2FJ223	METAL	2W	5%	22K Ω ▲
R855	ERJ6GEYJ752	S.M.CARB	0.1W	5%	7K5 Ω
R857	ERJ6GEYJ752	S.M.CARB	0.1W	5%	7K5 Ω
R858	ERJ6GEYJ752	S.M.CARB	0.1W	5%	7K5 Ω
R859	ERJ6GEYJ753	S.M.CARB	0.1W	5%	75K Ω
R861	ERD25TJ331	CARBON	0.25W	5%	330 Ω
R862	ERD25TJ272F	CARBON	0.25W	5%	2K7 Ω
R863	ERDS1TJ560	CARBON	0.5W	5%	56 Ω
R864	ERDS1TJ151	CARBON	0.5W	5%	150 Ω
R865	ERJ6GEY0R00	S.M.CARB	0.1W	5%	0 Ω
R867	ERJ6GEYJ103	S.M.CARB	0.1W	5%	10K Ω
R868	ERJ6GEYJ223	S.M.CARB	0.1W	5%	22K Ω
R869	ERJ6GEY0R00	S.M.CARB	0.1W	5%	0 Ω
R870	ERJ6GEYJ272	S.M.CARB	0.1W	5%	2K7 Ω
R871	ERJ6GEYJ153	S.M.CARB	0.1W	5%	15K Ω
R872	ERG1SJ183	METAL	1W	5%	18K Ω
R873	ERG1SJ223	METAL	1W	5%	22K Ω
R874	ERDS2TJ104T	CARBON	2W	5%	100K Ω
R876	ERJ6GEYJ103	S.M.CARB	0.1W	5%	10K Ω
R877	ERW2PKR33	WOUND	2W	20%	R33 Ω ▲
R878	ERJ6GEYJ473	S.M.CARB	0.1W	5%	47K Ω
R879	ERG3FJ680H	METAL	3W	5%	68 Ω ▲
R880	ERGS5FJ120H	METAL	5W	5%	12 Ω ▲
R882	ERG2FJ120	METAL	2W	5%	12 Ω ▲
R890	ERX1FJ3R9P	FUSIBLE	1W	5%	3R9 Ω ▲
R913	ERJ6GEYJ183	S.M.CARB	0.1W	5%	18K Ω
R914	ERJ6GEYJ332	S.M.CARB	0.1W	5%	3K3 Ω
R915	ERJ6GEYJ821	S.M.CARB	0.1W	5%	820 Ω
R916	ERJ6GEYJ221	S.M.CARB	0.1W	5%	220 Ω
R917	ERJ6GEYJ121	S.M.CARB	0.1W	5%	120 Ω
R918	ERJ6GEY0R00	S.M.CARB	0.1W	5%	0 Ω
R919	ERQ14AJW390	FUSIBLE	0.25W	5%	39 Ω ▲
R920	ERQ14AJW390	FUSIBLE	0.25W	5%	39 Ω ▲
R922	ERDS2TJ683T	CARBON	2W	5%	68K Ω
R923	ERDS2TJ683T	CARBON	2W	5%	68K Ω
R924	ERDS1FYJ390	CARBON	0.5W	5%	39 Ω ▲
R925	ERJ6GEY0R00	S.M.CARB	0.1W	5%	0 Ω
R926	ERJ6GEY0R00	S.M.CARB	0.1W	5%	0 Ω
R927	ERD25TJ122	CARBON	0.25W	5%	1K2 Ω
R928	ERD25TJ5R6	CARBON	0.25W	5%	5R6 Ω
R929	ERDS1FVJ471	CARBON	0.5W	5%	470 Ω ▲
R931	ERDS1FYJ390	CARBON	0.5W	5%	39 Ω ▲
R935	ERQ14AJW3R9	FUSIBLE	0.25W	5%	3R9 Ω ▲
R936	ERQ1CJP102	FUSIBLE	1W	5%	1K Ω ▲
R937	ERQ14AJW100	FUSIBLE	0.25W	5%	10 Ω ▲
R938	ERD25TJ122	CARBON	0.25W	5%	1K2 Ω
R941	ERD25TJ5R6	CARBON	0.25W	5%	5R6 Ω
R1051	ERJ6GEYJ102	S.M.CARB	0.1W	5%	1K Ω
R1062	ERJ6GEYJ271	S.M.CARB	0.1W	5%	270 Ω
R1063	ERJ6GEYJ103	S.M.CARB	0.1W	5%	10K Ω
R1101	ERJ6GEYJ101	S.M.CARB	0.1W	5%	100 Ω
R1102	ERJ6GEYJ102	S.M.CARB	0.1W	5%	1K Ω
R1103	ERJ6GEYJ331	S.M.CARB	0.1W	5%	330 Ω
R1104	ERJ6GEYJ331	S.M.CARB	0.1W	5%	330 Ω
R1105	ERJ6GEYJ101	S.M.CARB	0.1W	5%	100 Ω
R1106	ERJ6GEYJ104	S.M.CARB	0.1W	5%	100K Ω

Cct Ref	Parts Number	Description			
R1107	ERJ6GEYJ104	S.M.CARB	0.1W	5%	100K Ω
R1108	ERJ6GEYJ102	S.M.CARB	0.1W	5%	1K Ω
R1109	ERJ6GEYJ472	S.M.CARB	0.1W	5%	4K7 Ω
R1110	ERJ6GEYJ472	S.M.CARB	0.1W	5%	4K7 Ω
R1111	ERJ6GEYJ103	S.M.CARB	0.1W	5%	10K Ω
R1112	ERJ6GEYJ473	S.M.CARB	0.1W	5%	47K Ω
R1113	ERJ6GEYJ101	S.M.CARB	0.1W	5%	100 Ω
R1114	ERJ6GEYJ101	S.M.CARB	0.1W	5%	100 Ω
R1115	ERJ6GEYJ471	S.M.CARB	0.1W	5%	470 Ω
R1116	ERJ6GEYJ101	S.M.CARB	0.1W	5%	100 Ω
R1117	ERJ6GEYJ101	S.M.CARB	0.1W	5%	100 Ω
R1118	ERJ6GEYJ472	S.M.CARB	0.1W	5%	4K7 Ω
R1119	ERJ6GEYJ472	S.M.CARB	0.1W	5%	4K7 Ω
R1120	ERJ6GEYJ101	S.M.CARB	0.1W	5%	100 Ω
R1121	ERJ6GEYJ101	S.M.CARB	0.1W	5%	100 Ω
R1123	ERJ6GEYJ101	S.M.CARB	0.1W	5%	100 Ω
R1124	ERJ6GEYJ1R0	S.M.CARB	0.1W	5%	1 Ω
R1125	ERJ6GEYJ472	S.M.CARB	0.1W	5%	4K7 Ω
R1126	ERJ6GEYJ101	S.M.CARB	0.1W	5%	100 Ω
R1127	ERJ6GEYJ101	S.M.CARB	0.1W	5%	100 Ω
R1128	ERJ6GEYJ682	S.M.CARB	0.1W	5%	6K8 Ω
R1129	ERJ6GEYJ682	S.M.CARB	0.1W	5%	6K8 Ω
R1130	ERJ6GEYJ103	S.M.CARB	0.1W	5%	10K Ω
R1131	ERJ6GEYJ103	S.M.CARB	0.1W	5%	10K Ω
R1132	ERJ6GEYJ101	S.M.CARB	0.1W	5%	100 Ω
R1133	ERJ6GEYJ272	S.M.CARB	0.1W	5%	2K7 Ω
R1136	ERJ6GEYJ273	S.M.CARB	0.1W	5%	27K Ω
R1137	ERJ6GEY0R00	S.M.CARB	0.1W	5%	0 Ω
R1138	ERJ6GEYJ105	S.M.CARB	0.1W	5%	1M Ω
R1139	ERJ6GEYJ471	S.M.CARB	0.1W	5%	470 Ω
R1140	ERJ6GEYJ471	S.M.CARB	0.1W	5%	470 Ω
R1141	ERJ6GEYJ471	S.M.CARB	0.1W	5%	470 Ω
R1145	ERJ6GEYJ101	S.M.CARB	0.1W	5%	100 Ω
R1146	ERJ6GEYJ101	S.M.CARB	0.1W	5%	100 Ω
R1147	ERJ6GEYJ101	S.M.CARB	0.1W	5%	100 Ω
R1148	ERJ6GEYJ101	S.M.CARB	0.1W	5%	100 Ω
R1149	ERJ6GEYJ223	S.M.CARB	0.1W	5%	22K Ω
R1151	ERJ6GEYJ101	S.M.CARB	0.1W	5%	100 Ω
R1152	ERJ6GEYJ101	S.M.CARB	0.1W	5%	100 Ω
R1156	ERJ6GEYJ101	S.M.CARB	0.1W	5%	100 Ω
R1157	ERJ6GEYJ103	S.M.CARB	0.1W	5%	10K Ω
R1158	ERJ6GEYJ101	S.M.CARB	0.1W	5%	100 Ω
R1159	ERJ6GEY0R00	S.M.CARB	0.1W	5%	0 Ω
R1160	ERJ6GEYJ223	S.M.CARB	0.1W	5%	22K Ω
R1161	ERJ6GEYJ103	S.M.CARB	0.1W	5%	10K Ω
R1163	ERJ6GEY0R00	S.M.CARB	0.1W	5%	0 Ω
R1164	ERJ6GEY0R00	S.M.CARB	0.1W	5%	0 Ω
R1165	ERJ6GEY0R00	S.M.CARB	0.1W	5%	0 Ω
R1166	ERJ6GEY0R00	S.M.CARB	0.1W	5%	0 Ω
R1167	ERJ6GEYJ100	S.M.CARB	0.1W	5%	10 Ω
R1168	ERJ6GEYJ473	S.M.CARB	0.1W	5%	47K Ω
R1169	ERJ6GEYJ472	S.M.CARB	0.1W	5%	4K7 Ω
R1170	ERJ6GEYJ273	S.M.CARB	0.1W	5%	27K Ω
R1171	ERJ6GEYJ224	S.M.CARB	0.1W	5%	220K Ω
R1172	ERJ6GEYJ223	S.M.CARB	0.1W	5%	22K Ω
R1173	ERJ6GEYJ104	S.M.CARB	0.1W	5%	100K Ω
R1174	ERJ6GEYJ221	S.M.CARB	0.1W	5%	220 Ω
R1175	ERJ6GEYJ225	S.M.CARB	0.1W	5%	2M2 Ω
R1178	ERJ6GEY0R00	S.M.CARB	0.1W	5%	0 Ω
R1251	ERJ6GEYJ222	S.M.CARB	0.1W	5%	2K2 Ω
R1252	ERJ6GEYJ222	S.M.CARB	0.1W	5%	2K2 Ω
R1253	ERJ6GEYJ332	S.M.CARB	0.1W	5%	3K3 Ω
R1254	ERJ6GEYJ512	S.M.CARB	0.1W	5%	5K1 Ω
R1255	ERJ6GEYJ912	S.M.CARB	0.1W	5%	9K1 Ω
R1501	ERJ6GEYJ101	S.M.CARB	0.1W	5%	100 Ω
R1504	ERJ6GEYJ750	S.M.CARB	0.1W	5%	75 Ω

Cct Ref	Parts Number	Description			
R1505	ERJ6GEYJ750	S.M.CARB	0.1W	5%	75 Ω
R1506	ERJ6GEYJ750	S.M.CARB	0.1W	5%	75 Ω
R1507	ERJ6GEYJ101	S.M.CARB	0.1W	5%	100 Ω
R1508	ERJ6GEYJ391	S.M.CARB	0.1W	5%	390 Ω
R1509	ERJ6GEYJ750	S.M.CARB	0.1W	5%	75 Ω
R1510	ERJ6GEYJ750	S.M.CARB	0.1W	5%	75 Ω
R1511	ERJ6GEYJ750	S.M.CARB	0.1W	5%	75 Ω
R1512	ERJ6GEYJ750	S.M.CARB	0.1W	5%	75 Ω
R1513	ERJ6GEYJ102	S.M.CARB	0.1W	5%	1K Ω
R1514	ERJ6GEYJ472	S.M.CARB	0.1W	5%	4K7 Ω
R1515	ERJ6GEYJ752	S.M.CARB	0.1W	5%	7K5 Ω
R1521	ERJ6GEYJ750	S.M.CARB	0.1W	5%	75 Ω
R1522	ERJ6GEYJ391	S.M.CARB	0.1W	5%	390 Ω
R1523	ERJ6GEYJ331	S.M.CARB	0.1W	5%	330 Ω
R1524	ERJ6GEYJ102	S.M.CARB	0.1W	5%	1K Ω
R1525	ERJ6GEYJ750	S.M.CARB	0.1W	5%	75 Ω
R1526	ERJ6GEYJ391	S.M.CARB	0.1W	5%	390 Ω
R1527	ERJ6GEYJ122	S.M.CARB	0.1W	5%	1K2 Ω
R1528	ERJ6GEYJ102	S.M.CARB	0.1W	5%	1K Ω
R1529	ERJ6GEYJ122	S.M.CARB	0.1W	5%	1K2 Ω
R1530	ERJ6GEYJ750	S.M.CARB	0.1W	5%	75 Ω
R1531	ERJ6GEYJ102	S.M.CARB	0.1W	5%	1K Ω
R1532	ERJ6GEYJ391	S.M.CARB	0.1W	5%	390 Ω
R1533	ERJ6GEYJ122	S.M.CARB	0.1W	5%	1K2 Ω
R1534	ERJ6GEYJ102	S.M.CARB	0.1W	5%	1K Ω
R1535	ERJ6GEYJ750	S.M.CARB	0.1W	5%	75 Ω
R1536	ERJ6GEYJ391	S.M.CARB	0.1W	5%	390 Ω
R1537	ERJ6GEYJ682	S.M.CARB	0.1W	5%	6K8 Ω
R1538	ERJ6GEYJ331	S.M.CARB	0.1W	5%	330 Ω
R1539	ERJ6GEYJ271	S.M.CARB	0.1W	5%	270 Ω
R1540	ERJ6GEYJ682	S.M.CARB	0.1W	5%	6K8 Ω
R1541	ERJ6GEYJ103	S.M.CARB	0.1W	5%	10K Ω
R1542	ERJ6GEYJ471	S.M.CARB	0.1W	5%	470 Ω
R1543	ERJ6GEYJ101	S.M.CARB	0.1W	5%	100 Ω
R1544	ERJ6GEYJ101	S.M.CARB	0.1W	5%	100 Ω
R1545	ERJ6GEYJ101	S.M.CARB	0.1W	5%	100 Ω
R1546	ERJ6GEYJ101	S.M.CARB	0.1W	5%	100 Ω
R1547	ERJ6GEYJ101	S.M.CARB	0.1W	5%	100 Ω
R1548	ERJ6GEYJ101	S.M.CARB	0.1W	5%	100 Ω
R1549	ERJ6GEYJ101	S.M.CARB	0.1W	5%	100 Ω
R1550	ERJ6GEYJ101	S.M.CARB	0.1W	5%	100 Ω
R1551	ERJ6GEYJ101	S.M.CARB	0.1W	5%	100 Ω
R1552	ERJ6GEYJ101	S.M.CARB	0.1W	5%	100 Ω
R1553	ERJ6GEYJ101	S.M.CARB	0.1W	5%	100 Ω
R1556	ERJ6GEY0R00	S.M.CARB	0.1W	5%	0 Ω
R1557	ERJ6GEY0R00	S.M.CARB	0.1W	5%	0 Ω
R1574	ERJ6GEYJ682	S.M.CARB	0.1W	5%	6K8 Ω
R1577	ERJ6GEYJ103	S.M.CARB	0.1W	5%	10K Ω
R1578	ERJ6GEYJ103	S.M.CARB	0.1W	5%	10K Ω
R1579	ERJ6GEYJ101	S.M.CARB	0.1W	5%	100 Ω
R1580	ERJ6GEYJ101	S.M.CARB	0.1W	5%	100 Ω
R1584	ERJ6GEYJ471	S.M.CARB	0.1W	5%	470 Ω
R1585	ERJ6GEYJ471	S.M.CARB	0.1W	5%	470 Ω
R1586	ERJ6GEYJ471	S.M.CARB	0.1W	5%	470 Ω
R1587	ERJ6GEYJ152	S.M.CARB	0.1W	5%	1K5 Ω
R1588	ERJ6GEYJ511	S.M.CARB	0.1W	5%	510 Ω
R1589	ERJ6GEYJ152	S.M.CARB	0.1W	5%	1K5 Ω
R1590	ERJ6GEY0R00	S.M.CARB	0.1W	5%	0 Ω
R1598	ERJ6GEYJ472	S.M.CARB	0.1W	5%	4K7 Ω
R1601	ERJ6GEYJ750	S.M.CARB	0.1W	5%	75 Ω
R1602	ERJ6GEYJ750	S.M.CARB	0.1W	5%	75 Ω
R1603	ERJ6GEYJ750	S.M.CARB	0.1W	5%	75 Ω
R1604	ERJ6GEYJ750	S.M.CARB	0.1W	5%	75 Ω
R1900	ERQ12HJ150	FUSIBLE	0.1W	5%	15 Ω
R1901	ERJ6GEYJ273	S.M.CARB	0.1W	5%	27K Ω
R1902	ERJ6GEYJ183	S.M.CARB	0.1W	5%	18K Ω

Cct Ref	Parts Number	Description			
R1903	ERJ6GEYJ223	S.M.CARB	0.1W	5%	22K Ω
R1904	ERDS1TJ2R2	CARBON	0.5W	5%	2R2 Ω
R1905	ERJ6GEYJ753	S.M.CARB	0.1W	5%	75K Ω
R1906	ERJ6GEYJ753	S.M.CARB	0.1W	5%	75K Ω
R1907	ERJ6GEYJ753	S.M.CARB	0.1W	5%	75K Ω
R1908	ERJ6GEYJ103	S.M.CARB	0.1W	5%	10K Ω
R1909	ERDS1TJ2R2	CARBON	0.5W	5%	2R2 Ω
R1910	ERDS1TJ8R2	CARBON	0.5W	5%	8R2 Ω
R1911	ERDS1TJ8R2	CARBON	0.5W	5%	8R2 Ω
R1912	ERC12ZGK335D	SOLID	0.5W	10%	3M3 Ω [△]
R1913	ERJ6GEYJ472	S.M.CARB	0.1W	5%	4K7 Ω
R1914	ERJ6GEYJ272	S.M.CARB	0.1W	5%	2K7 Ω
R2101	ERJ6GEYJ103	S.M.CARB	0.1W	5%	10K Ω
R2102	ERJ6GEYJ101	S.M.CARB	0.1W	5%	100 Ω
R2103	ERJ6GEYJ101	S.M.CARB	0.1W	5%	100 Ω
R2109	ERJ6GEYJ183	S.M.CARB	0.1W	5%	18K Ω
R2110	ERJ6GEY0R00	S.M.CARB	0.1W	5%	0 Ω
R2111	ERJ6GEYJ221	S.M.CARB	0.1W	5%	220 Ω
R2112	ERJ6GEYJ102	S.M.CARB	0.1W	5%	1K Ω
R2113	ERJ6GEYJ562	S.M.CARB	0.1W	5%	5K6 Ω
R2114	ERJ6GEYJ101	S.M.CARB	0.1W	5%	100 Ω
R2115	ERJ6GEYJ822	S.M.CARB	0.1W	5%	8K2 Ω
R2116	ERJ6GEYJ101	S.M.CARB	0.1W	5%	100 Ω
R2117	ERJ6GEYJ101	S.M.CARB	0.1W	5%	100 Ω
R2118	ERJ6GEYJ822	S.M.CARB	0.1W	5%	8K2 Ω
R2119	ERJ6GEYJ101	S.M.CARB	0.1W	5%	100 Ω
R2120	ERJ6GEYJ222	S.M.CARB	0.1W	5%	2K2 Ω
R2200	ERJ6GEYJ183	S.M.CARB	0.1W	5%	18K Ω
R2201	ERJ6GEYJ393	S.M.CARB	0.1W	5%	39K Ω
R2202	ERJ6GEYJ103	S.M.CARB	0.1W	5%	10K Ω
R2203	ERJ6GEYJ103	S.M.CARB	0.1W	5%	10K Ω
R2204	ERJ6GEYJ682	S.M.CARB	0.1W	5%	6K8 Ω
R2206	ERJ6GEYJ272	S.M.CARB	0.1W	5%	2K7 Ω
R2207	ERJ6GEYJ123	S.M.CARB	0.1W	5%	12K Ω
R2208	ERJ6GEYJ103	S.M.CARB	0.1W	5%	10K Ω
R2209	ERJ6GEYJ103	S.M.CARB	0.1W	5%	10K Ω
R2210	ERJ6GEYJ822	S.M.CARB	0.1W	5%	8K2 Ω
R2211	ERJ6GEYJ682	S.M.CARB	0.1W	5%	6K8 Ω
R2212	ERJ6GEYJ224	S.M.CARB	0.1W	5%	220K Ω
R2213	ERJ6GEYJ103	S.M.CARB	0.1W	5%	10K Ω
R2214	ERJ6GEYJ103	S.M.CARB	0.1W	5%	10K Ω
R2215	ERJ6GEYJ223	S.M.CARB	0.1W	5%	22K Ω
R2216	ERJ6GEYJ222	S.M.CARB	0.1W	5%	2K2 Ω
R2217	ERJ6GEYJ102	S.M.CARB	0.1W	5%	1K Ω
R2218	ERJ6GEYJ151	S.M.CARB	0.1W	5%	150 Ω
R2219	ERJ6GEYJ222	S.M.CARB	0.1W	5%	2K2 Ω
R2220	ERJ6GEYJ183	S.M.CARB	0.1W	5%	18K Ω
R2221	ERJ6GEYJ393	S.M.CARB	0.1W	5%	39K Ω
R2222	ERJ6GEYJ103	S.M.CARB	0.1W	5%	10K Ω
R2223	ERJ6GEYJ103	S.M.CARB	0.1W	5%	10K Ω
R2224	ERJ6GEYJ682	S.M.CARB	0.1W	5%	6K8 Ω
R2226	ERJ6GEYJ272	S.M.CARB	0.1W	5%	2K7 Ω
R2227	ERJ6GEYJ123	S.M.CARB	0.1W	5%	12K Ω
R2228	ERJ6GEYJ154	S.M.CARB	0.1W	5%	150K Ω
R2229	ERJ6GEYJ151	S.M.CARB	0.1W	5%	150 Ω
R2230	ERJ6GEYJ822	S.M.CARB	0.1W	5%	8K2 Ω
R2231	ERJ6GEYJ682	S.M.CARB	0.1W	5%	6K8 Ω
R2232	ERJ6GEYJ224	S.M.CARB	0.1W	5%	220K Ω
R2233	ERJ6GEYJ103	S.M.CARB	0.1W	5%	10K Ω
R2234	ERJ6GEYJ103	S.M.CARB	0.1W	5%	10K Ω
R2235	ERJ6GEYJ223	S.M.CARB	0.1W	5%	22K Ω
R2236	ERJ6GEYJ102	S.M.CARB	0.1W	5%	1K Ω
R2237	ERJ6GEYJ103	S.M.CARB	0.1W	5%	10K Ω
R2238	ERJ6GEYJ103	S.M.CARB	0.1W	5%	10K Ω
R2239	ERJ6GEYJ154	S.M.CARB	0.1W	5%	150K Ω
R2240	ERJ6GEYJ473	S.M.CARB	0.1W	5%	47K Ω

Cct Ref	Parts Number	Description			
R2241	ERJ6GEYJ220	S.M.CARB	0.1W	5%	22 Ω
R2302	ERJ6GEYJ104	S.M.CARB	0.1W	5%	100K Ω
R2303	ERJ6GEYJ101	S.M.CARB	0.1W	5%	100 Ω
R2304	ERJ6GEYJ471	S.M.CARB	0.1W	5%	470 Ω
R2305	ERJ6GEYJ102	S.M.CARB	0.1W	5%	1K Ω
R2306	ERJ6GEYJ103	S.M.CARB	0.1W	5%	10K Ω
R2308	ERJ6GEYJ104	S.M.CARB	0.1W	5%	100K Ω
R2309	ERJ6GEYJ101	S.M.CARB	0.1W	5%	100 Ω
R2310	ERJ6GEYJ471	S.M.CARB	0.1W	5%	470 Ω
R2311	ERJ6GEYJ102	S.M.CARB	0.1W	5%	1K Ω
R2312	ERJ6GEYJ103	S.M.CARB	0.1W	5%	10K Ω
R3001	ERJ6GEYJ101	S.M.CARB	0.1W	5%	100 Ω
R3002	ERJ6GEYJ471	S.M.CARB	0.1W	5%	470 Ω
R3003	ERJ6GEYJ101	S.M.CARB	0.1W	5%	100 Ω
R3004	ERJ6GEYJ153	S.M.CARB	0.1W	5%	15K Ω
R3005	ERJ6GEYJ101	S.M.CARB	0.1W	5%	100 Ω
R3006	ERJ6GEYJ471	S.M.CARB	0.1W	5%	470 Ω
R3007	ERJ6GEYJ101	S.M.CARB	0.1W	5%	100 Ω
R3008	ERJ6GEYJ153	S.M.CARB	0.1W	5%	15K Ω
R3010	ERD25TJ750	CARBON	0.25W	5%	75 Ω
R3013	ERJ6GEYJ101	S.M.CARB	0.1W	5%	100 Ω
R3014	ERJ6GEYJ471	S.M.CARB	0.1W	5%	470 Ω
R3015	ERJ6GEYJ101	S.M.CARB	0.1W	5%	100 Ω
R3016	ERJ6GEYJ153	S.M.CARB	0.1W	5%	15K Ω
R3017	ERJ6GEYJ101	S.M.CARB	0.1W	5%	100 Ω
R3018	ERJ6GEYJ471	S.M.CARB	0.1W	5%	470 Ω
R3019	ERJ6GEYJ101	S.M.CARB	0.1W	5%	100 Ω
R3020	ERJ6GEYJ153	S.M.CARB	0.1W	5%	15K Ω
R3021	ERJ6GEYJ750	S.M.CARB	0.1W	5%	75 Ω
R3046	ERJ6GEYJ101	S.M.CARB	0.1W	5%	100 Ω
R3047	ERJ6GEYJ101	S.M.CARB	0.1W	5%	100 Ω
R3048	ERJ6GEYJ103	S.M.CARB	0.1W	5%	10K Ω
R3049	ERJ6GEYJ101	S.M.CARB	0.1W	5%	100 Ω
R3050	ERJ6GEYJ103	S.M.CARB	0.1W	5%	10K Ω
R3057	ERJ6GEYJ750	S.M.CARB	0.1W	5%	75 Ω
R3201	ERJ6GEYJ750	S.M.CARB	0.1W	5%	75 Ω
R3202	ERDS1TJ151	CARBON	0.5W	5%	150 Ω
R3203	ERDS1TJ151	CARBON	0.5W	5%	150 Ω
R3204	ERG2FJ221	METAL	2W	5%	220 Ω [△]
R3205	ERG2FJ221	METAL	2W	5%	220 Ω [△]
R3207	ERJ6GEYJ101	S.M.CARB	0.1W	5%	100 Ω
R3208	ERJ6GEYJ153	S.M.CARB	0.1W	5%	15K Ω
R3209	ERJ6GEYJ101	S.M.CARB	0.1W	5%	100 Ω
R3210	ERJ6GEYJ153	S.M.CARB	0.1W	5%	15K Ω
R3211	ERJ6GEYJ223	S.M.CARB	0.1W	5%	22K Ω
R3212	ERJ6GEYJ223	S.M.CARB	0.1W	5%	22K Ω
R3213	ERJ6GEYJ102	S.M.CARB	0.1W	5%	1K Ω
R3214	ERJ6GEYJ683	S.M.CARB	0.1W	5%	68K Ω
R3215	ERJ6GEYJ302	S.M.CARB	0.1W	5%	3K Ω
R3216	ERJ6GEYJ750	S.M.CARB	0.1W	5%	75 Ω
R3217	ERJ6GEYJ223	S.M.CARB	0.1W	5%	22K Ω
R3218	ERJ6GEYJ223	S.M.CARB	0.1W	5%	22K Ω
R3219	ERJ6GEYJ102	S.M.CARB	0.1W	5%	1K Ω
R3220	ERJ6GEYJ683	S.M.CARB	0.1W	5%	68K Ω
R3221	ERJ6GEYJ302	S.M.CARB	0.1W	5%	3K Ω
R3222	ERJ6GEYJ223	S.M.CARB	0.1W	5%	22K Ω
R3223	ERJ6GEYJ223	S.M.CARB	0.1W	5%	22K Ω
R3224	ERJ6GEYJ102	S.M.CARB	0.1W	5%	1K Ω
R3225	ERJ6GEYJ683	S.M.CARB	0.1W	5%	68K Ω
R3226	ERJ6GEYJ302	S.M.CARB	0.1W	5%	3K Ω
R3227	ERJ6GEYJ102	S.M.CARB	0.1W	5%	1K Ω
R3228	ERJ6GEYJ273	S.M.CARB	0.1W	5%	27K Ω
R3229	ERJ6GEYJ103	S.M.CARB	0.1W	5%	10K Ω
R3230	ERJ6GEYJ302	S.M.CARB	0.1W	5%	3K Ω
R3231	ERJ6GEYJ122	S.M.CARB	0.1W	5%	1K2 Ω
R3232	ERJ6GEYJ242	S.M.CARB	0.1W	5%	2K4 Ω

Cct Ref	Parts Number	Description				
R3233	ERJ6GEYJ391	S.M.CARB	0.1W	5%	390 Ω	
R3234	ERJ6GEYJ102	S.M.CARB	0.1W	5%	1K Ω	
R3354	ERJ6GEYJ102	S.M.CARB	0.1W	5%	1K Ω	
R3355	ERJ6GEYJ391	S.M.CARB	0.1W	5%	390 Ω	
R3356	ERJ6GEYJ681	S.M.CARB	0.1W	5%	680 Ω	
R3357	ERJ6GEYJ681	S.M.CARB	0.1W	5%	680 Ω	
R3358	ERJ6GEYJ681	S.M.CARB	0.1W	5%	680 Ω	
R3360	ERDS1TJ471	CARBON	0.5W	5%	470 Ω	
R3361	ERO50PKF1133	METAL	0.5W	5%	110K Ω	△
R3362	ERJ6GEYJ102	S.M.CARB	0.1W	5%	1K Ω	
R3363	ERJ6GEYJ102	S.M.CARB	0.1W	5%	1K Ω	
R3364	ERJ6GEYJ102	S.M.CARB	0.1W	5%	1K Ω	
R3601	ERJ6GEYJ101	S.M.CARB	0.1W	5%	100 Ω	
R3602	ERJ6GEYJ101	S.M.CARB	0.1W	5%	100 Ω	
R3603	ERJ6GEYJ101	S.M.CARB	0.1W	5%	100 Ω	
R3614	ERJ6GEYJ391	S.M.CARB	0.1W	5%	390 Ω	
R3918	ERJ6GEYJ272	S.M.CARB	0.1W	5%	2K7 Ω	
R3919	ERJ6GEYJ273	S.M.CARB	0.1W	5%	27K Ω	
R3920	ERJ6GEYJ103	S.M.CARB	0.1W	5%	10K Ω	
R3921	ERJ6GEYJ153	S.M.CARB	0.1W	5%	15K Ω	
R3922	EVMEASA00B53	CONTROL			5K Ω	
R3923	ERJ6GEYJ562	S.M.CARB	0.1W	5%	5K6 Ω	
R3925	ERO25CKF1272	METAL	0.25W	5%	2K7 Ω	△
R3926	ERO25CKF3242	METAL	0.25W	5%	2K4 Ω	△
R3927	ERD25TJ103	CARBON	0.25W	5%	10K Ω	
R3928	ERDS1FJ103	CARBON	0.5W	5%	10K Ω	△
R3929	ERJ6GEYJ472	S.M.CARB	0.1W	5%	4K7 Ω	
R3930	ERDS1FJ103	CARBON	0.5W	5%	10K Ω	△
R3931	ERJ6GEYJ561	S.M.CARB	0.1W	5%	560 Ω	
R3932	ERJ6GEYJ103	S.M.CARB	0.1W	5%	10K Ω	
R3933	ERJ6GEYJ103	S.M.CARB	0.1W	5%	10K Ω	
R3934	ERJ6GEYJ564	S.M.CARB	0.1W	5%	560K Ω	
R3935	ERDS1FJ561	CARBON	0.5W	5%	56 Ω	△
R3936	ERJ6GEYJ820	S.M.CARB	0.1W	5%	82 Ω	
R3938	EVMEASA00B53	CONTROL			5K Ω	
R3939	ERJ6GEYJ472	S.M.CARB	0.1W	5%	4K7 Ω	
R3941	ERJ6GEYJ101	S.M.CARB	0.1W	5%	100 Ω	
R3942	ERD25TJ123	CARBON	0.25W	5%	12K Ω	
R3943	ERDS1TJ104	CARBON	0.5W	5%	100K Ω	
R3944	ERJ6GEYJ125	S.M. CAR	0.1W	5%	1M2 Ω	
R3945	ERJ6GEYJ125	S.M. CAR	0.1W	5%	1M2 Ω	
R3946	ERJ6GEYJ104	S.M.CARB	0.1W	5%	100K Ω	
R3947	ERG2FJ123H	METAL	2W	5%	12K Ω	△
R3949	ERDS1FJ332	CARBON	0.5W	5%	3K3 Ω	△
R3950	ERG3FJ471	METAL	3W	5%	470 Ω	△
R3951	ERD25TJ334	CARBON	0.25W	5%	330K Ω	
R3952	ERJ6GEYJ101	S.M.CARB	0.1W	5%	100 Ω	
R3954	ERD25TJ473	CARBON	0.25W	5%	47K Ω	
R3955	ERJ6GEYJ123	S.M.CARB	0.1W	5%	12K Ω	
R3956	ERDS2TJ104T	CARBON	2W	5%	100K Ω	
R3957	ERDS2TJ104T	CARBON	2W	5%	100K Ω	
R3958	ERDS2TJ104T	CARBON	2W	5%	100K Ω	
R3959	ERDS2TJ104T	CARBON	2W	5%	100K Ω	
R3960	ERJ6GEYJ622	S.M.CARB	0.1W	5%	6K2 Ω	
R3961	ERJ6GEYJ562	S.M.CARB	0.1W	5%	5K6 Ω	
R3962	ERD25TJ563	CARBON	0.25W	5%	56K Ω	
R3963	ERJ6GEYJ563	S.M.CARB	0.1W	5%	56K Ω	
R3972	ERG2FJ471	METAL	2W	5%	470 Ω	△
R3973	ERJ6GEYJ102	S.M.CARB	0.1W	5%	1K Ω	
R3974	ERJ6GEYJ103	S.M.CARB	0.1W	5%	10K Ω	
R3975	ERJ6GEYJ102	S.M.CARB	0.1W	5%	1K Ω	
R3976	ERJ6GEYJ102	S.M.CARB	0.1W	5%	1K Ω	
R3978	ERJ6GEY0R00	S.M.CARB	0.1W	5%	0 Ω	
R3981	ERQ14AJ220	FUSIBLE	0.25W	5%	22 Ω	△
R3982	ERJ6GEYJ333	S.M.CARB	0.1W	5%	33K Ω	
R3983	ERJ6GEYJ823	S.M.CARB	0.1W	5%	82K Ω	

Cct Ref	Parts Number	Description				
R3984	ERJ6GEYJ123	S.M.CARB	0.1W	5%	12K Ω	
R3985	ERJ6GEYJ102	S.M.CARB	0.1W	5%	1K Ω	
R3986	ERJ6GEYJ103	S.M.CARB	0.1W	5%	10K Ω	
R3987	ERJ6GEYJ332	S.M.CARB	0.1W	5%	3K3 Ω	
R3988	ERJ6GEYJ684	S.M.CARB	0.1W	5%	680K Ω	
R3989	ERJ6GEYJ221	S.M.CARB	0.1W	5%	220 Ω	
R3990	ERJ6GEYJ103	S.M.CARB	0.1W	5%	10K Ω	
R3991	ERJ6GEYJ103	S.M.CARB	0.1W	5%	10K Ω	
R3992	ERJ6GEY0R00	S.M.CARB	0.1W	5%	0 Ω	
R3993	ERJ6GEYJ472	S.M.CARB	0.1W	5%	4K7 Ω	
R3994	ERJ6GEYJ103	S.M.CARB	0.1W	5%	10K Ω	
CAPACITORS						
C102	ECJ2VF1H103Z	CERAMIC	50V		10nF	
C103	ECJ2VF1H104Z	CERAMIC	50V		100nF	
C106	ECUV1H560JCX	S.M. CAP	50V		56pF	
C107	ECJ2VF1H104Z	CERAMIC	50V		100nF	
C108	ECA1CM100GB	ELECT	16V		10μF	
C109	ECUV1H102JCX	S.M. CAP	50V		1nF	
C110	ECJ2VF1H103Z	CERAMIC	50V		10nF	
C111	ECA1HMR33GB	ELECT	50V		0.33μF	
C117	ECJ2VF1H103Z	CERAMIC	50V		10nF	
C118	ECJ2VF1H104Z	CERAMIC	50V		100nF	
C119	ECA1CM221GB	ELECT	16V		220μF	
C120	ECA1CM221GB	ELECT	16V		220μF	
C121	ECUV1H561KBX	S.M. CAP	50V		560pF	
C124	ECUV1H220JCX	S.M. CAP	50V		22pF	
C125	ECUV1H100DCX	S.M. CAP	50V		10pF	
C251	ECA1CM100GB	ELECT	16V		10μF	
C252	ECUV1H103KBX	S.M. CAP	50V		10nF	
C253	ECA1HM4R7GB	ELECT	50V		4.7μF	
C254	ECQV1H224JL3	FILM	50V		220nF	
C255	ECA1EM101GB	ELECT	25V		100μF	
C256	ECUV1H103KBX	S.M. CAP	50V		10nF	
C257	ECA1HM4R7GB	ELECT	50V		4.7μF	
C258	ECA1CM100GB	ELECT	16V		10μF	
C259	ECQV1H224JL3	FILM	50V		220nF	
C260	ECA1VM102GB	ELECT	35V		1nF	
C261	ECA1VM102GB	ELECT	35V		1nF	
C262	ECA1HM2R2GB	ELECT	50V		2.2μF	
C263	ECA1HM010GB	ELECT	50V		1μF	
C264	ECA1HHG222E	ELECT	50V		2200μF	
C265	ECA1HM2R2GB	ELECT	50V		2.2μF	
C266	ECA1HM010GB	ELECT	50V		1μF	
C267	ECJ2VB1H104K	CERAMIC	50V		100nF	
C268	ECJ2VB1H104K	CERAMIC	50V		100nF	
C270	ECJ2VB1H104K	CERAMIC	50V		100nF	
C350	ECUV1H102JCX	S.M. CAP	50V		1nF	
C352	ECUV1H224ZFX	S.M. CAP	50V		220nF	
C353	ECJ2YB1H104K	CERAMIC	50V		100nF	
C354	ECQM2104KZ	FILM	250V		100nF	
C355	ECKC2H102J	CERAMIC	500V		1nF	△
C358	ECUV1H222JCX	S.M. CAP	50V		2.2nF	
C360	ECUV1H102JCX	S.M. CAP	50V		1nF	
C362	ECUV1H224ZFX	S.M. CAP	50V		220nF	
C363	ECJ2YB1H104K	CERAMIC	50V		100nF	
C364	ECQM2104KZ	FILM	250V		100nF	
C365	ECKC2H102J	CERAMIC	500V		1nF	△
C368	ECUV1H222JCX	S.M. CAP	50V		2.2nF	
C369	ECUV1H220JCX	S.M. CAP	50V		22pF	
C370	ECUV1H102JCX	S.M. CAP	50V		1nF	
C372	ECUV1H224ZFX	S.M. CAP	50V		220nF	
C373	ECJ2YB1H104K	CERAMIC	50V		100nF	
C374	ECQM2104KZ	FILM	250V		100nF	
C375	ECKC2H102J	CERAMIC	500V		1nF	△
C378	ECUV1H222JCX	S.M. CAP	50V		2.2nF	
C381	ECA1HM101GB	ELECT	50V		100μF	

Cct Ref	Parts Number	Description			
C382	ECA1CM471GB	ELECT	16V	470µF	
C383	ECUV1H103KBX	S.M. CAP	50V	10nF	
C384	ECQM2104KZ	FILM	250V	100nF	
C385	ECA2EM220B	ELECT	250V	22µF	
C386	ECKC3D332J	CERAMIC	2KV	3.3µF	
C395	ECQV1H104J	FILM	50V	100nF	
C451	ECUV1H102JX	S.M. CAP	50V	1nF	
C453	ECUV1H152KBX	S.M. CAP	50V	1.5pF	
C454	ECQV1H105JZ	FILM	50V	1µF	
C455	ECA1HM100GB	ELECT	50V	10µF	
C456	ECA1HHG221B	ELECT	50V	220µF	
C459	ECQB1224KFW	FILM	100V	220nF	
C508	ECQB1H103J	FILM	50V	10nF	
C509	ECA1VM470B	ELECT	35V	47µF	
C511	ECQM2A104KZ	FILM	100V	100nF	
C551	ECKC3D561J	CERAMIC	2KV	560pF	△
C552	ECWH15H102JN	FILM	1500V	1nF	
C557	ECKC2H471J	CERAMIC	500V	470pF	△
C558	ECA1HHG471E	ELECT	50V	470µF	
C561	ECA1EHG102B	ELECT	25V	1000µF	
C562	ECKC2H101J	CERAMIC	500V	100pF	△
C563	ECA2EHG220B	ELECT	250V	20µF	
C564	ECEA2AU2R2	ELECT	100V	2.2µF	
C565	ECQP1H273J	FILM	100V	2700µF	
C566	ECKC2H471J	CERAMIC	500V	470pF	△
C567	ECA1EHG102B	ELECT	25V	1000µF	
C568	ECKC2H471J	CERAMIC	500V	470pF	△
C569	ECKC2H102J	CERAMIC	500V	1nF	△
C570	ECUV1H221JCX	S.M. CAP	50V	220pF	
C571	ECUV1H221JCX	S.M. CAP	50V	220pF	
C572	ECJ2YB1H104K	CERAMIC	50V	100nF	
C581	ECWF4684JBB	FILM	400V	680nF	
C582	ECWF4304JBP	FILM	400V	300nF	
C583	ECWH20472JVB	FILM	200V	4.7nF	
C584	ECWH20512JVB	FILM	200V	5.1nF	
C586	ECQF4123JZH	FILM	400V	12nF	△
C586	ECWF4304JBP	FILM	400V	300nF	
C587	ECQF4153JZH	FILM	400V	1.5nF	△
C608	ECUV1H103KBX	S.M. CAP	50V	10nF	
C609	ECUV1H270JCX	S.M. CAP	50V	27pF	
C623	ECUV1H121JCX	S.M. CAP	50V	120pF	
C624	ECUV1H121JCX	S.M. CAP	50V	120pF	
C625	ECQV1H224JL3	FILM	50V	220nF	
C626	ECA1CM100GB	ELECT	16V	10µF	
C627	ECJ2VB1C104K	CERAMIC	16V	100nF	
C628	ECQV1H224JL3	FILM	50V	220nF	
C701	ECA1HHG101B	ELECT	50V	100µF	
C702	ECUV1H103KBX	S.M. CAP	50V	10nF	
C703	ECEA1HGE100	ELECT	50V	10µF	
C704	ECUV1H223KBX	S.M. CAP	50V	22nF	
C705	ECQB1H561J	FILM CAP	50V	560µF	
C709	ECQV1H105JZ	FILM	50V	1µF	
C801	ECQE6104K	FILM	600V	100nF	△
C806	ECKWNA101MBC	CERAMIC	400V	100µF	△
C807	ECKC2H472J	CERAMIC	500V	4.7nF	△
C808	ECKC2H472J	CERAMIC	500V	4.7nF	△
C809	ECKC2H472J	CERAMIC	500V	4.7nF	△
C810	ECKC2H472J	CERAMIC	500V	4.7nF	△
C811	ECOS2GA221CA	ELECT	400V	220µF	
C814	ECKC3D102J	CERAMIC	2KV	1nF	△
C815	ECKC1H471J	CERAMIC	50V	470pF	
C816	ECA1EM101GB	ELECT	25V	100µF	
C818	ECKCNS332J	CERAMIC	1.2KV	3.3nF	△
C819	ECQB1H102K	FILM	50V	1nF	
C820	ECJ2VF1H104Z	CERAMIC	50V	100nF	
C823	222233821154	FILM	250	150nF	△

Cct Ref	Parts Number	Description			
C839	ECA1CM100GB	ELECT	16V	10µF	
C840	ECJ2YB1H104K	CERAMIC	50V	100nF	
C841	ECA1AM222B	ELECT	10V	2200µF	
C842	ECA1CM100GB	ELECT	16V	10µF	
C850	ECKC3D471JB	CERAMIC	2KV	470pF	△
C851	ECA2CHG221E	ELECT	160V	220µF	
C852	EEUEB2D101B	CERAMIC	250V	100pF	
C853	ECKC2H471J	CERAMIC	500V	470pF	△
C854	ECA1EM102GB	ELECT	25V	100µF	
C855	ECKC2H471J	CERAMIC	500V	470pF	△
C856	ECA1AHG332B	ELECT	10V	3.3nF	
C857	ECKC2H471J	CERAMIC	500V	470pF	△
C858	ECEA1HGE102	ELECT	50V	1000µF	
C859	ECJ2VF1H104Z	CERAMIC	50V	100nF	
C860	ECA1HM101GB	ELECT	50V	100µF	
C862	ECJ2VF1H104Z	CERAMIC	50V	100nF	
C863	ECA1HM101GB	ELECT	50V	100µF	
C866	ECJ2VF1H104Z	CERAMIC	50V	100nF	
C867	ECA1CM100GB	ELECT	16V	10µF	
C868	ECA1CM100GB	ELECT	16V	10µF	
C869	ECA1EM101GB	ELECT	25V	100µF	
C870	ECA1EM471GB	ELECT	25V	470µF	
C871	ECEA1CU332	ELECT	16V	3300µF	
C872	ECA1CM471GB	ELECT	16V	470µF	
C873	ECA1CM100GB	ELECT	16V	10µF	
C875	ECA2CM4R7B	ELECT	160V	10µF	
C876	ECA1HHG101B	ELECT	50V	100µF	
C902	ECA1VM101GB	ELECT	35V	100µF	
C904	ECJ2VF1H103Z	CERAMIC	50V	10nF	
C906	ECUV1H563KBX	S.M. CAP	50V	56nF	
C907	ECUV1H331JCX	S.M. CAP	50V	330pF	
C909	ECKC2H472J	CERAMIC	500V	4.7nF	△
C910	ECKC2H472J	CERAMIC	500V	4.7nF	△
C912	ECA2EM220B	ELECT	250V	22µF	
C913	ECA1HM101GB	ELECT	50V	100µF	
C914	ECA1HM101GB	ELECT	50V	100µF	
C916	ECA2EM220B	ELECT	250V	22µF	
C917	ECA1HM100GB	ELECT	50V	10µF	
C918	ECJ2VF1H103Z	CERAMIC	50V	10nF	
C919	ECCR2H270J	CERAMIC	500V	27pF	
C1061	ECUV1H103KBX	S.M. CAP	50V	10nF	
C1062	ECA1HM101GB	ELECT	50V	100µF	
C1063	ECUV1H331JCX	S.M. CAP	50V	330pF	
C1101	ECJ2VF1H104Z	CERAMIC	50V	100nF	
C1102	ECA0JM101G	ELECT	6.3V	100µF	
C1103	ECUV1H220JCX	S.M. CAP	50V	22pF	
C1104	ECUV1H220JCX	S.M. CAP	50V	22pF	
C1105	ECUV1H101JCX	S.M. CAP	50V	100pF	
C1106	ECKC2H681J	CERAMIC	500V	680pF	△
C1108	ECJ2VB1H333K	CERAMIC	50V	33nF	
C1111	ECA1CM100GB	ELECT	16V	10µF	
C1112	ECUV1H103KBX	S.M. CAP	50V	10nF	
C1115	ECJ3VB1C474K	CERAMIC	16V	470nF	
C1116	ECUV1H472KBX	S.M. CAP	50V	4.7nF	
C1117	ECJ2VF1H104Z	CERAMIC	50V	100nF	
C1118	ECUV1H103KBX	S.M. CAP	50V	10nF	
C1119	ECUV1H221JCX	S.M. CAP	50V	220pF	
C1120	ECJ2VF1H104Z	CERAMIC	50V	100nF	
C1121	ECUV1H221JCX	S.M. CAP	50V	220pF	
C1123	ECUV1H471JCX	S.M. CAP	50V	470pF	
C1124	ECUV1H391JCX	S.M. CAP	50V	390pF	
C1125	ECUV1H391JCX	S.M. CAP	50V	390pF	
C1126	ECUV1H391JCX	S.M. CAP	50V	390pF	
C1127	ECUV1H561JCX	S.M. CAP	50V	560pF	
C1129	ECUV1H270JCX	S.M. CAP	50V	27pF	
C1130	ECA1CM221GB	ELECT	16V	220µF	

Cct Ref	Parts Number	Description		
C1501	ECUV1H271JCX	S.M. CAP	50V	270pF
C1502	ECUV1H271JCX	S.M. CAP	50V	270pF
C1503	ECUV1H271JCX	S.M. CAP	50V	270pF
C1504	ECUV1H271JCX	S.M. CAP	50V	270pF
C1505	ECUV1H271JCX	S.M. CAP	50V	270pF
C1506	ECUV1H271JCX	S.M. CAP	50V	270pF
C1507	ECUV1H271JCX	S.M. CAP	50V	270pF
C1508	ECUV1H271JCX	S.M. CAP	50V	270pF
C1509	ECQV1H684J	FILM	50V	680nF
C1510	ECQV1H684J	FILM	50V	680nF
C1511	ECQV1H684J	FILM	50V	680nF
C1512	ECQV1H684J	FILM	50V	680nF
C1513	ECJ2VB1H102K	CERAMIC	50V	1nF
C1514	ECEA1CKA100	ELECT	16V	10µF
C1515	ECJ2VB1H103K	CERAMIC	50V	10nF
C1516	ECEA1CN101	ELECT	16V	100µF
C1517	ECJ2VB1H473K	CERAMIC	50V	47nF
C1518	ECEA1CKA101	ELECT	16V	100µF
C1519	ECUV1H050CCX	S.M. CAP	50V	50pF
C1520	ECUV1H050CCX	S.M. CAP	50V	50pF
C1521	ECJ2VB1H103K	CERAMIC	50V	10nF
C1522	ECEA1CKA100	ELECT	16V	10µF
C1524	ECEA1CKA100	ELECT	16V	10µF
C1527	ECUV1H103KBX	S.M. CAP	50V	10nF
C1528	ECUV1H103KBX	S.M. CAP	50V	10nF
C1529	ECUV1H103KBX	S.M. CAP	50V	10nF
C1530	ECUV1H271JCX	S.M. CAP	50V	270pF
C1531	ECUV1H271JCX	S.M. CAP	50V	270pF
C1540	ECUV1H222JCX	S.M. CAP	50V	2.2nF
C1541	ECJ2VB1H333K	CERAMIC	50V	33nF
C1542	ECJ2VB1H333K	CERAMIC	50V	33nF
C1543	ECJ2VB1C224K	CERAMIC	16V	220nF
C1544	ECJ2VB1H333K	CERAMIC	50V	33nF
C1545	ECEA1CKA100	ELECT	16V	10µF
C1546	ECEA1CKA100	ELECT	16V	10µF
C1547	ECJ2VB1H103K	CERAMIC	50V	10nF
C1548	ECJ2VB1H103K	CERAMIC	50V	10nF
C1549	ECJ2VB1H103K	CERAMIC	50V	10nF
C1550	ECJ2VB1H103K	CERAMIC	50V	10nF
C1551	ECJ2VB1H103K	CERAMIC	50V	10nF
C1552	ECJ2VB1H103K	CERAMIC	50V	10nF
C1553	ECEA1CKA100	ELECT	16V	10µF
C1554	ECJ2VB1H103K	CERAMIC	50V	10nF
C1555	ECJ2VB1C104K	CERAMIC	16V	100nF
C1556	ECUV1H270JCX	S.M. CAP	50V	27pF
C1557	ECUV1H270JCX	S.M. CAP	50V	27pF
C1558	ECJ2VB1H103K	CERAMIC	50V	10nF
C1559	ECEA1CKA100	ELECT	16V	10µF
C1560	ECEA1CKA100	ELECT	16V	10µF
C1561	ECJ2VB1C104K	CERAMIC	16V	100nF
C1562	ECJ2VB1C104K	CERAMIC	16V	100nF
C1563	ECJ2VB1C104K	CERAMIC	16V	100nF
C1564	ECJ2VB1C104K	CERAMIC	16V	100nF
C1566	ECUV1H270JCX	S.M. CAP	50V	27pF
C1567	ECEA1CKA100	ELECT	16V	10µF
C1568	ECJ2VB1H103K	CERAMIC	50V	10nF
C1569	ECEA1CKA100	ELECT	16V	10µF
C1570	ECJ2VB1H103K	CERAMIC	50V	10nF
C1571	ECJ2VB1H103K	CERAMIC	50V	10nF
C1572	ECEA1CKA100	ELECT	16V	10µF
C1574	ECEA1CKA100	ELECT	16V	10µF
C1575	ECEA1CKA100	ELECT	16V	10µF
C1576	ECJ2VB1H103K	CERAMIC	50V	10nF
C1577	ECJ2VC1H100D	ELECT	50V	10µF
C1580	ECJ2VB1H103K	CERAMIC	50V	10nF
C1581	ECJ2VB1C224K	CERAMIC	16V	220nF

Cct Ref	Parts Number	Description		
C1582	ECJ2VB1C224K	CERAMIC	16V	220nF
C1583	ECJ2VB1C224K	CERAMIC	16V	220nF
C1584	ECJ2VB1H473K	CERAMIC	50V	47nF
C1585	ECEA1CKA100	ELECT	16V	10µF
C1590	ECUV1H270JCX	S.M. CAP	50V	27pF
C1591	ECEA1CKA100	ELECT	16V	10µF
C1592	ECJ2VB1H391K	CERAMIC	50V	390µF
C1594	ECJ2VB1H391K	CERAMIC	50V	390µF
C1596	ECJ2VB1H391K	CERAMIC	50V	390µF
C1597	ECJ1VC1H220J	CERAMIC	50V	22pF
C1603	ECUV1H271JCX	S.M. CAP	50V	270pF
C1604	ECJ2VB1C224K	CERAMIC	16V	220nF
C1605	ECJ2VB1H152K	ELECT	50V	1.5nF
C1606	ECJ2VB1H391K	CERAMIC	50V	390µF
C1607	ECUV1H271KBX	S.M. CAP	50V	270µF
C1608	ECJ2VB1H152K	ELECT	50V	1.5nF
C1609	ECJ2VB1H473K	CERAMIC	50V	47nF
C1610	ECJ2VB1C683K	ELECT	16V	68nF
C1611	ECJ2VB1C683K	ELECT	16V	68nF
C1612	ECJ2VB1C683K	ELECT	16V	68nF
C1613	ECJ2VB1H152K	ELECT	50V	1.5nF
C1614	ECJ2VB1H473K	CERAMIC	50V	47nF
C1615	ECJ2VB1C224K	CERAMIC	16V	220nF
C1616	ECJ2VB1H152K	ELECT	50V	1.5nF
C1617	ECJ2VB1H391K	CERAMIC	50V	390µF
C1620	ECJ2VB1H391K	CERAMIC	50V	390µF
C1621	ECJ2VB1H152K	ELECT	50V	1.5nF
C1622	ECJ2VB1H223K	CERAMIC	50V	22nF
C1623	ECJ2VB1H391K	CERAMIC	50V	390µF
C1900	ECQB1H153K	FILM	50V	15nF
C1901	ECUV1H103KBX	S.M. CAP	50V	10nF
C1903	ECA1EM470GB	ELECT	25V	47µF
C1904	ECQB1H104J	FILM	50V	100nF
C1905	ECQB1H104J	FILM	50V	100nF
C1906	ECQE2A474MWB	FILM	250V	470nF
C1909	ECUV1H103KBX	S.M. CAP	50V	10nF
C2101	ECUV1H102JCX	S.M. CAP	50V	1nF
C2102	ECUV1H102JCX	S.M. CAP	50V	1nF
C2103	ECUV1H102JCX	S.M. CAP	50V	1nF
C2104	ECUV1H102JCX	S.M. CAP	50V	1nF
C2105	ECUV1H102JCX	S.M. CAP	50V	1nF
C2106	ECUV1H102JCX	S.M. CAP	50V	1nF
C2107	ECUV1H102JCX	S.M. CAP	50V	1nF
C2108	ECUV1H102JCX	S.M. CAP	50V	1nF
C2109	ECUV1H102JCX	S.M. CAP	50V	1nF
C2110	ECUV1H102JCX	S.M. CAP	50V	1nF
C2111	ECA1CM100GB	ELECT	16V	10µF
C2112	ECA1CM100GB	ELECT	16V	10µF
C2113	ECA1HM3R3GB	ELECT	50V	3.3µF
C2114	ECJ2VF1H104Z	CERAMIC	50V	100nF
C2115	ECUV1H221JCX	S.M. CAP	50V	220pF
C2116	ECUV1H221JCX	S.M. CAP	50V	220pF
C2117	ECUV1H221JCX	S.M. CAP	50V	220pF
C2118	ECUV1H221JCX	S.M. CAP	50V	220pF
C2119	ECUV1H221JCX	S.M. CAP	50V	220pF
C2120	ECUV1H221JCX	S.M. CAP	50V	220pF
C2121	ECA1CM100GB	ELECT	16V	10µF
C2122	ECJ2VF1H104Z	CERAMIC	50V	100nF
C2123	ECUV1H221JCX	S.M. CAP	50V	220pF
C2124	ECUV1H560JCX	S.M. CAP	50V	56pF
C2125	ECUV1H470JCX	S.M. CAP	50V	47pF
C2126	ECUV1H560JCX	S.M. CAP	50V	56pF
C2127	ECUV1H010CCX	S.M. CAP	50V	1pF
C2128	ECUV1H010CCX	S.M. CAP	50V	1pF
C2129	ECA1CM102B	ELECT	16V	1000µF
C2130	ECA1CM331B	ELECT	16V	330µF

Cct Ref	Parts Number	Description		
C2134	ECJ2VF1H103Z	CERAMIC	50V	10nF
C2135	ECA1HM101GB	ELECT	50V	100µF
C2136	ECJ2VF1H104Z	CERAMIC	50V	100nF
C2137	ECA1CM100GB	ELECT	16V	10µF
C2138	ECUV1H471KBX	S.M. CAP	50V	470pF
C2139	ECUV1H221JCX	S.M. CAP	50V	220pF
C2140	ECA1HM101GB	ELECT	50V	100µF
C2141	ECUV1H152JCX	S.M. CAP	50V	1.5pF
C2200	ECUV1H562KBX	S.M. CAP	50V	5.6nF
C2201	ECA1HM100GB	ELECT	50V	10µF
C2202	ECA0JM101G	ELECT	6.3V	100µF
C2203	ECUV1H153KBX	S.M. CAP	50V	15nF
C2204	ECA1CM470GB	ELECT	16V	47µF
C2205	ECUV1H562KBX	S.M. CAP	50V	5.6nF
C2206	ECA1HM2R2GB	ELECT	50V	2.2µF
C2207	ECUV1H103KBX	S.M. CAP	50V	10nF
C2208	ECUV1H683KBX	S.M. CAP	50V	68nF
C2209	ECUV1H681JCX	S.M. CAP	50V	680pF
C2211	ECJ2VB1C104K	CERAMIC	16V	100nF
C2212	ECJ2VB1C104K	CERAMIC	16V	100nF
C2213	ECUV1H473KBX	S.M. CAP	50V	47nF
C2215	ECUV1H103KBX	S.M. CAP	50V	10nF
C2216	ECUV1H121JCX	S.M. CAP	50V	120pF
C2217	ECUV1H473KBX	S.M. CAP	50V	47nF
C2218	ECUV1H153KBX	S.M. CAP	50V	15nF
C2220	ECUV1H562KBX	S.M. CAP	50V	5.6nF
C2221	ECA1HM100GB	ELECT	50V	10µF
C2222	ECA0JM101G	ELECT	6.3V	100µF
C2225	ECUV1H562KBX	S.M. CAP	50V	5.6nF
C2226	ECA1HM2R2GB	ELECT	50V	2.2µF
C2227	ECUV1H103KBX	S.M. CAP	50V	10nF
C2228	ECUV1H683KBX	S.M. CAP	50V	68nF
C2229	ECUV1H681JCX	S.M. CAP	50V	680pF
C2231	ECJ2VB1C104K	CERAMIC	16V	100nF
C2232	ECJ2VB1C104K	CERAMIC	16V	100nF
C2235	ECUV1H103KBX	S.M. CAP	50V	10nF
C2236	ECUV1H121JCX	S.M. CAP	50V	120pF
C2240	ECA1CM471GB	ELECT	16V	470µF
C2301	ECUV1H222JCX	S.M. CAP	50V	2.2nF
C2302	ECA1CM470GB	ELECT	16V	47µF
C2303	ECUV1H222JCX	S.M. CAP	50V	2.2nF
C2304	ECA1CM470GB	ELECT	16V	47µF
C3001	ECUV1H222JCX	S.M. CAP	50V	2.2nF
C3002	ECUV1H222JCX	S.M. CAP	50V	2.2nF
C3003	ECA1CM470GB	ELECT	16V	47µF
C3005	ECUV1H561JCX	S.M. CAP	50V	560pF
C3006	ECJ3VB1C474K	CERAMIC	16V	470nF
C3007	ECUV1H222JCX	S.M. CAP	50V	2.2nF
C3008	ECUV1H222JCX	S.M. CAP	50V	2.2nF
C3009	ECUV1H222JCX	S.M. CAP	50V	2.2nF
C3010	ECA1CM470GB	ELECT	16V	47µF
C3012	ECUV1H561JCX	S.M. CAP	50V	560pF
C3013	ECJ3VB1C474K	CERAMIC	16V	470nF
C3014	ECUV1H222JCX	S.M. CAP	50V	2.2nF
C3015	ECUV1H222JCX	S.M. CAP	50V	2.2nF
C3016	ECUV1H222JCX	S.M. CAP	50V	2.2nF
C3017	ECA1CM470GB	ELECT	16V	47µF
C3019	ECUV1H561JCX	S.M. CAP	50V	560pF
C3020	ECJ3VB1C474K	CERAMIC	16V	470nF
C3021	ECUV1H222JCX	S.M. CAP	50V	2.2nF
C3022	ECUV1H222JCX	S.M. CAP	50V	2.2nF
C3023	ECUV1H222JCX	S.M. CAP	50V	2.2nF
C3024	ECA1CM470GB	ELECT	16V	47µF
C3026	ECUV1H561JCX	S.M. CAP	50V	560pF
C3027	ECJ3VB1C474K	CERAMIC	16V	470nF
C3028	ECUV1H222JCX	S.M. CAP	50V	2.2nF

Cct Ref	Parts Number	Description		
C3030	ECUV1H271JCX	S.M. CAP	50V	270pF
C3031	ECUV1H271JCX	S.M. CAP	50V	270pF
C3032	ECUV1H271JCX	S.M. CAP	50V	270pF
C3111	ECUV1H391JCX	S.M. CAP	50V	390pF
C3201	ECUV1H103KBX	S.M. CAP	50V	10nF
C3202	ECUV1H103KBX	S.M. CAP	50V	10nF
C3203	ECUV1H561JCX	S.M. CAP	50V	560pF
C3204	ECUV1H561JCX	S.M. CAP	50V	560pF
C3205	ECA1HM470GB	ELECT	50V	47µF
C3206	ECUV1H561JCX	S.M. CAP	50V	560pF
C3207	ECUV1H561JCX	S.M. CAP	50V	560pF
C3208	ECA1HM470GB	ELECT	50V	47µF
C3209	ECUV1H103KBX	S.M. CAP	50V	10nF
C3210	ECJ2VB1C104K	CERAMIC	16V	100nF
C3211	ECUV1H103KBX	S.M. CAP	50V	10nF
C3212	ECUV1H103KBX	S.M. CAP	50V	10nF
C3213	ECUV1H103KBX	S.M. CAP	50V	10nF
C3214	ECJ2VB1C104K	CERAMIC	16V	100nF
C3215	ECUV1H103KBX	S.M. CAP	50V	10nF
C3216	ECA1CM330GB	ELECT	16V	33pF
C3217	ECJ2VB1C104K	CERAMIC	16V	100nF
C3221	ECA1CM221GB	ELECT	16V	220µF
C3351	ECA1CM221GB	ELECT	16V	220µF
C3909	ECQB1H153K	FILM	50V	15nF
C3910	ECA1HM010GB	ELECT	50V	1µF
C3911	ECQB1H153K	FILM	50V	15nF
C3912	ECQM1222JZ	FILM	100V	2.2nF
C3913	ECQV1H105JZ	FILM	50V	1µF
C3914	ECA1CM331B	ELECT	16V	330µF
C3915	ECQB1H103J	FILM	50V	10nF
C3916	ECQB1H563K	FILM	50V	56nF
C3917	ECQB1H683K	FILM	50V	68nF
C3918	ECQB1H222J	FILM	50V	2.2nF
C3919	ECQB1H333J	FILM	50V	33nF
C3920	ECQB1H332K	FILM	50V	3.3nF
C3922	ECKC3A182J	CERAMIC	1KV	1800pF
C3923	ECEA1HN100UB	ELECT	50V	10µF
C3924	ECKC3A122J	CERAMIC	1KV	1.2nF
C3925	ECKC3A151J	CERAMIC	1KV	150pF
C3926	ECKC3A681J	CERAMIC	1KV	680pF
C3927	ECA1HM010GB	ELECT	50V	1µF
C3928	ECQM4223JZW	FILM	400V	22nF
C3929	ECQM4223JZW	FILM	400V	22nF
C3931	ECKC3D101J	CERAMIC	2KV	100pF
C3932	ECUV1H103KBX	S.M. CAP	50V	10nF
C3933	ECKC3A471J	CERAMIC	1KV	470pF
C3936	ECA2CM330B	ELECT	160V	33µF
C3937	ECQV1H104J	FILM	50V	100nF
C3939	ECA1HM3R3GB	ELECT	50V	3.3µF
C3940	ECA1CM471GB	ELECT	16V	470µF
C3941	ECA1HMR47GB	ELECT	50V	0.47µF
C3942	ECEA1HN010UB	ELECT	50V	1µF
C3943	ECUV1H101JCX	S.M. CAP	50V	100pF
C3944	ECQB1H103J	FILM	50V	10nF
C3945	ECA1HM100GB	ELECT	50V	10µF
C3946	ECQB1H333J	FILM	50V	33nF
C3947	ECKC3D102J	CERAMIC	2KV	1nF
C3948	ECQV1H105JZ	FILM	50V	1µF
C3950	ECJ2YB1H104K	CERAMIC	50V	100nF
C3951	ECA1HM101GB	ELECT	50V	100µF
C3952	ECKC3D102J	CERAMIC	2KV	1nF
C3953	ECQP1H473JZ3	FILM	100V	47nF
C3954	ECQB1H152K	FILM	50V	1.5nF
C3955	ECQB1H563K	FILM	50V	56nF
TERMINALS AND LINKS				
JK381	0330770044	CRT SOCKET		

Cct Ref	Parts Number	Description	
JK2301	JPJ841101320	RCA SOCKET	
JK3001	0350808500	SCART SOCKET	
JK3201	TJB8E026	AV TERMINAL	
SWITCHES			
S802	ESB92S11B	SWITCH	△
S1251	EVQ21405R	SWITCH	
S1252	EVQ21405R	SWITCH	
S1253	EVQ21405R	SWITCH	
S1254	EVQ21405R	SWITCH	
S1255	EVQ21405R	SWITCH	
RELAYS			
RL801	DLS12D1-OM	RELAY	△
INSTRUCTION BOOKS			
	TQB8E3289	INSTRUCTION BOOK	△

Cct Ref	Parts Number	Description
---------	--------------	-------------

SCHEMATIC DIAGRAMS FOR MODELS TX-32PK25 (EURO-4H CHASSIS)



IMPORTANT SAFETY NOTICE

Components identified by  mark have special characteristics important for safety. When replacing any of these components, use only manufacturers' specified parts.



NOTE

1. RESISTOR
All resistors are carbon 1/4W resistor, unless marked otherwise.
Unit of resistance is OHM (Ω) (k=1,000, M=1,000,000)
2. CAPACITORS
All capacitors are ceramic 50V unless marked otherwise.
Unit of capacitance is μ F unless otherwise stated.
3. COIL
Unit of inductance is μ H, unless otherwise stated.

4. TEST POINT
 Test Point Position

5. EARTH SYMBOL
 Chassis Earth (Cold)
 Line Earth (Hot)

6. VOLTAGE MEASUREMENT
Voltage is measured by a d.c. voltmeter.
Measurement conditions are as follows:
Power source a.c. 220V-240V, 50Hz
Receiving Signal Colour Bar signal (RF)
All customer controls Maximum position

7.
 Indicates the Video signal path
 Indicates the Audio signal path

These schematic diagrams are the latest at time of printing and are subject to change without notice.

REMARKS

- a. Do not touch the hot part, or the hot and cold parts at the same time, as you are liable to a shock hazard.
- b. Do not short circuit the hot and cold circuits as electrical components may be damaged.
- c. Do not connect an instrument, such as an oscilloscope, to the hot and cold circuits simultaneously as this may cause fuse failure. Connect the earth of the instruments to the earth connection of the circuit being measured.
- d. Make sure to disconnect the power plug before removing the chassis.

NOTE

1. The Power Supply Circuit contains a circuit area, which uses a separate power supply to isolate the earth connection. The circuit is defined by HOT and COLD indications in the schematic diagram. All circuits, except the Power Circuit, are COLD.

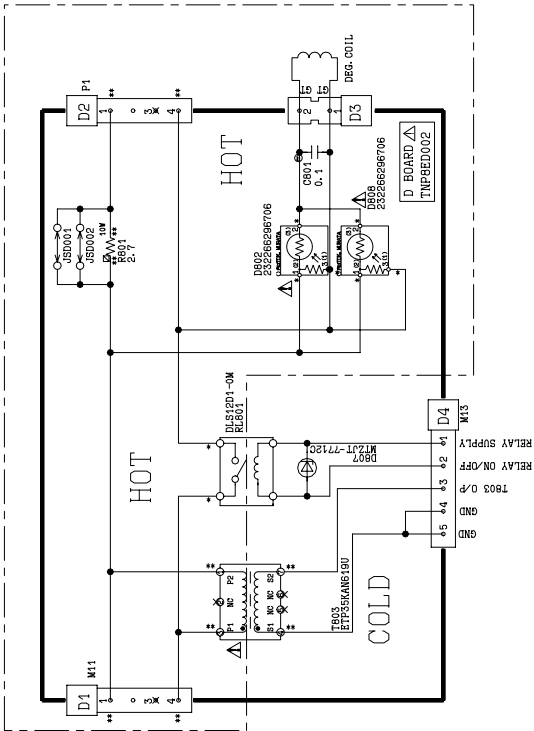

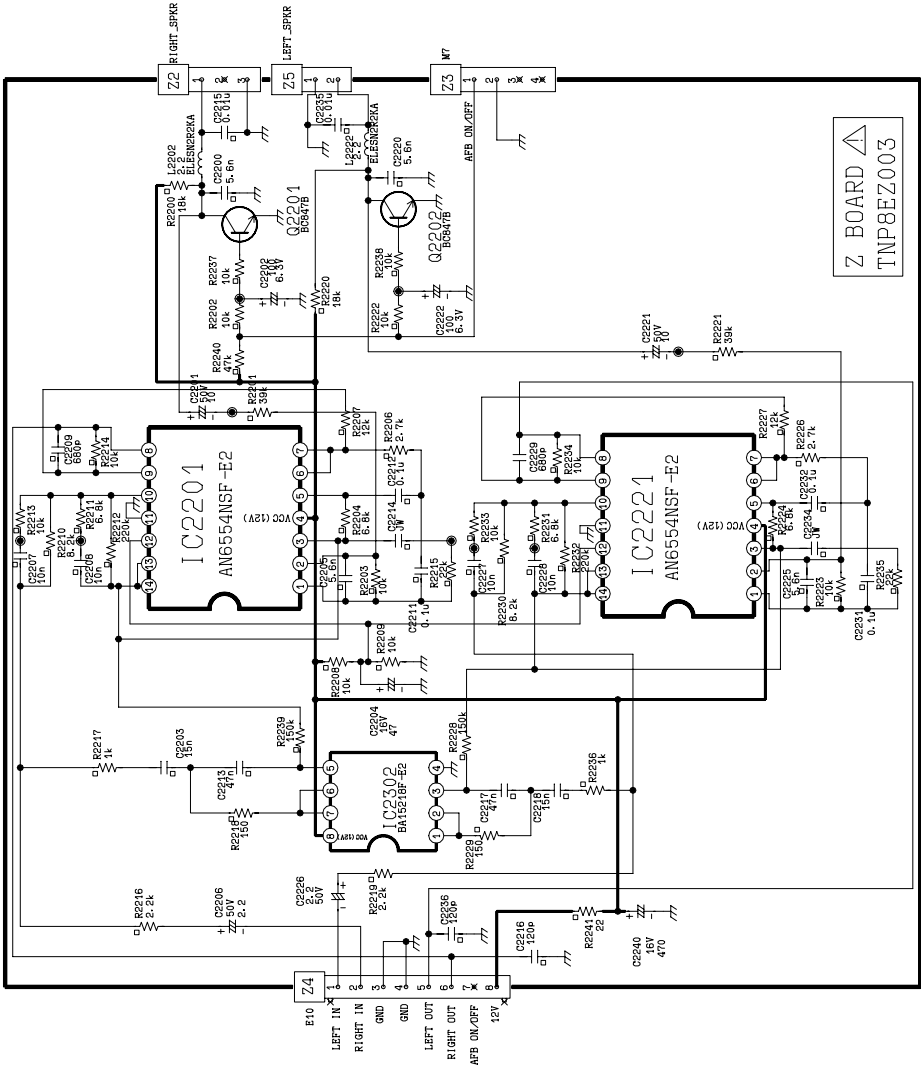

Z BOARD

 TNP8EZ003

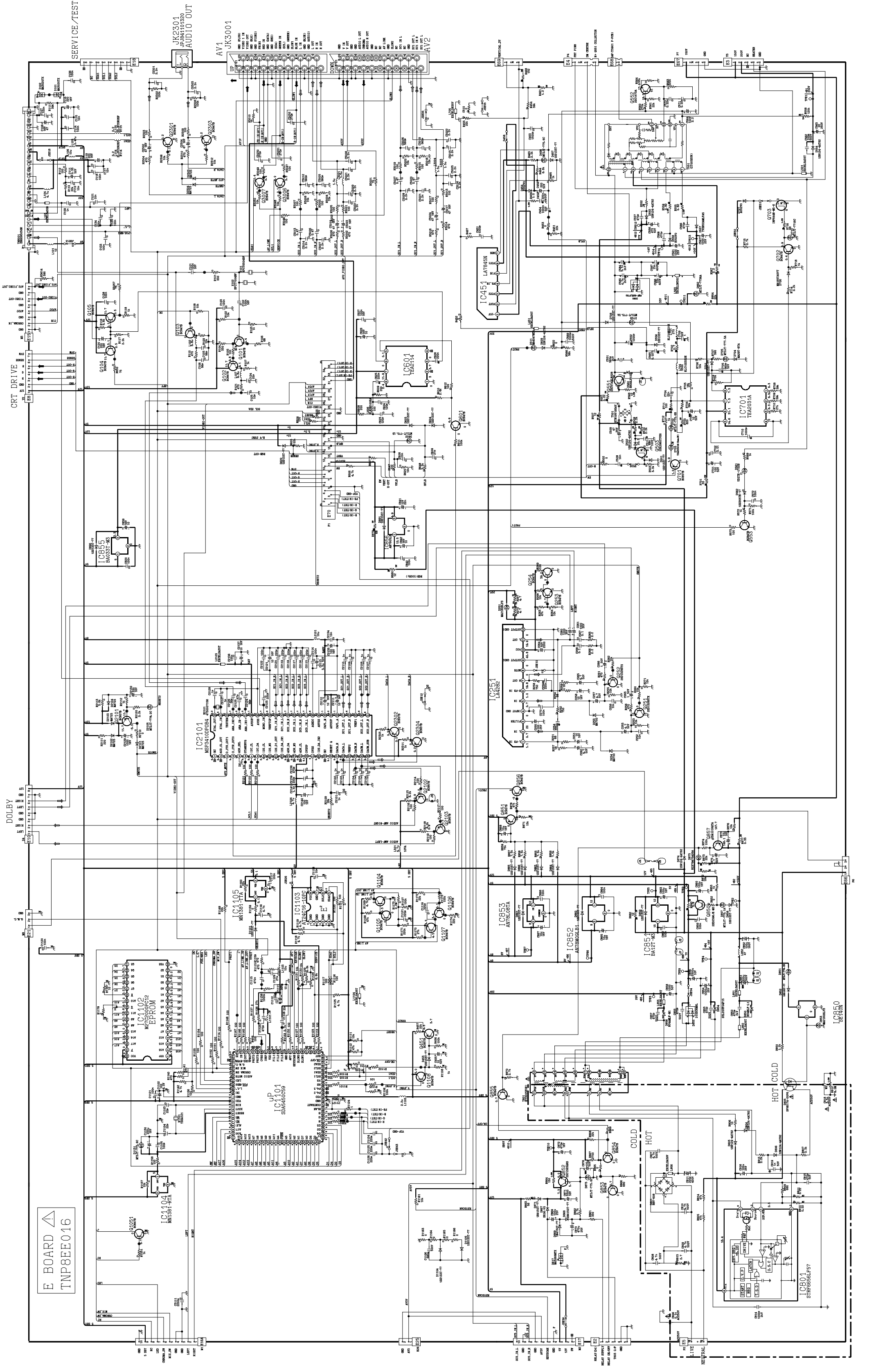

E BOARD
TNP8EE016

DOLBY

CRT DRIVE

SERVICE/TEST

JK2304
AUDIO OUT

AV1
JK3001

AV2

IC955
BA8337-M3

IC102
M1381-T14
EPROM

IC104
M1381-T14

IC201
MSP3410DDB4

IC405
M1381-T14

IC1103
TEA2014

IC604
TEA2014

IC251
LA9202

IC953
ANT407A

IC852
ANT407B1

IC851
BA121-M3

IC801
STRF656LF57

IC701
TEA2031A

IC850

HOT COLD

COLD HOT

IC451
LA9202