

## SUPER-ANGULON 5.6/75

$$\begin{aligned}
 f' &= 75.7 \text{ mm} & \beta_p' &= 0.973 \\
 s_F &= -53.2 \text{ mm} & s_{EP} &= 24.5 \text{ mm} \\
 s_{F'} &= 50.7 \text{ mm} & s_{AP}' &= -22.9 \text{ mm} \\
 HH' &= 29.6 \text{ mm} & \Sigma d &= 77.0 \text{ mm}
 \end{aligned}$$

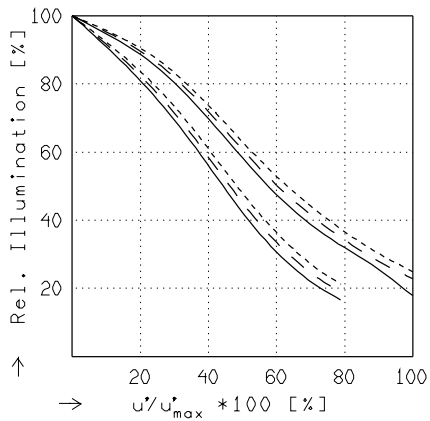
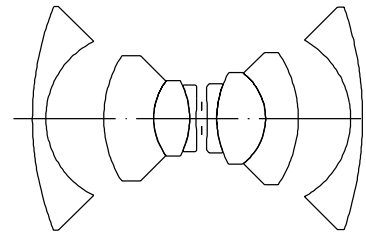

### RELATIVE ILLUMINATION

The relative illumination is shown for the given focal distances or magnifications.

$$f / 5.6 \qquad f / 22.0$$

—	$\beta' = 0.0000$	$u_{\max}' = 99.5$	$00' = \infty$
- -	$\beta' = -0.0500$	$u_{\max}' = 99.6$	$00' = 1698.$
- · - ·	$\beta' = -0.1000$	$u_{\max}' = 99.6$	$00' = 945.$

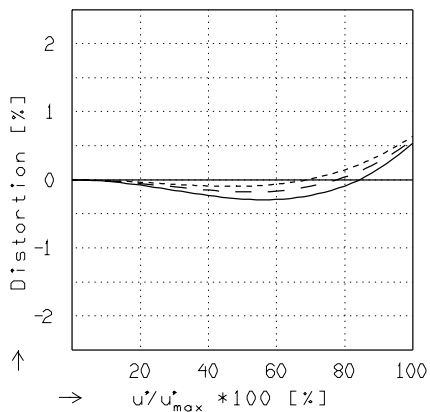

### DISTORTION

Distortion is shown for the given focal distances or magnifications. Positive values indicate pincushion distortion and negative values barrel distortion.

—	$\beta' = 0.0000$	$u_{\max}' = 99.5$	$00' = \infty$
- -	$\beta' = -0.0500$	$u_{\max}' = 99.6$	$00' = 1698.$
- · - ·	$\beta' = -0.1000$	$u_{\max}' = 99.6$	$00' = 945.$

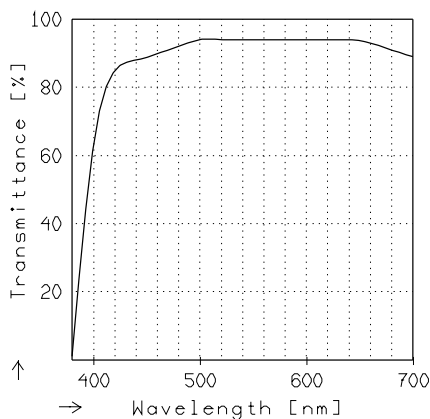

### TRANSMITTANCE

Relative spectral transmittance is shown with reference to wavelength.

Jos. Schneider Optische Werke GmbH  
 Ringstrasse 132 55543 Bad Kreuznach Germany

# SUPER-ANGULON 5.6/75

MODULATION with reference to the relative image height

Wavelength $\lambda$	[nm]	546	644	588	480	436	405
Spectral weighting	[%]	24,6	18,6	22,1	12,4	15,2	7,1
Spatial frequency R	[1/mm]	5	10	20			
Image- $\emptyset$ f / 5.6	[mm]	156.0					
Image- $\emptyset$ f / 22.0	[mm]	198.0					

radial —  
tangential - -

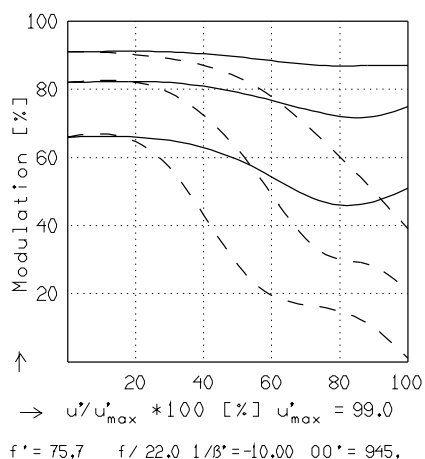
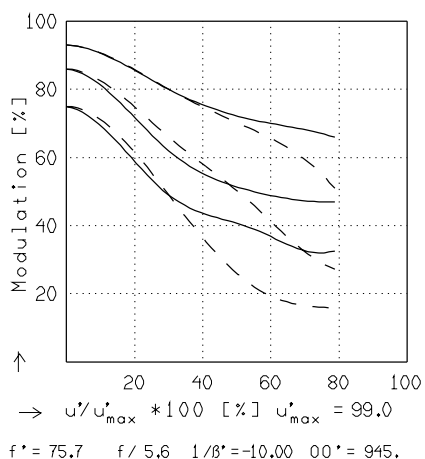
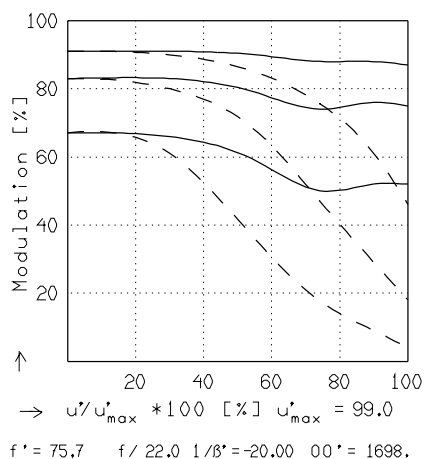
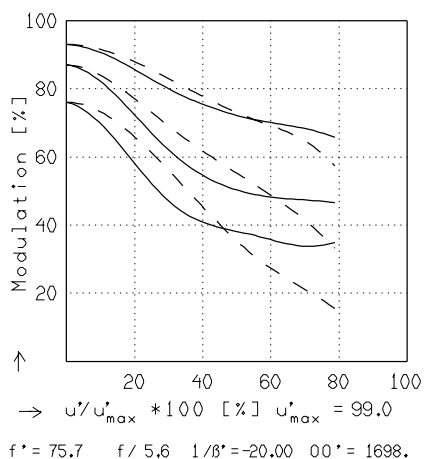
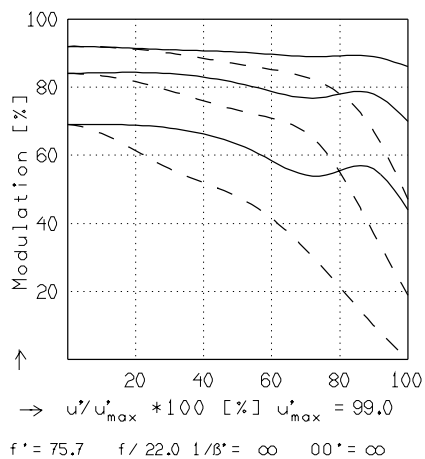
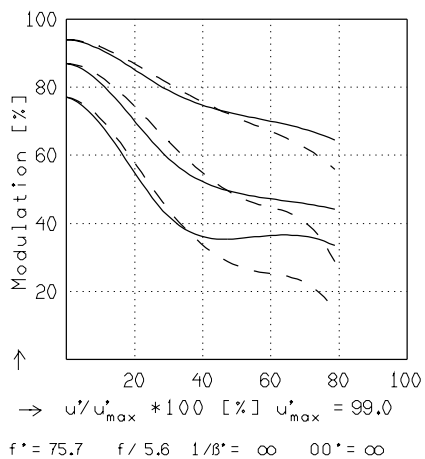

Focusing :  $MTF_{max}$  at  $f / 5.6$  ,  $R = 20$  1/mm,  $u'/u'_{max} = 0$



## SUPER-ANGULON XL 5.6/72

$$\begin{aligned}
 f' &= 72.0 \text{ mm} & \beta_p' &= 0.967 \\
 s_F &= -48.7 \text{ mm} & s_{EP} &= 25.7 \text{ mm} \\
 s_{F'} &= 47.3 \text{ mm} & s_{AP}' &= -22.3 \text{ mm} \\
 HH' &= 31.3 \text{ mm} & \Sigma d &= 79.3 \text{ mm}
 \end{aligned}$$

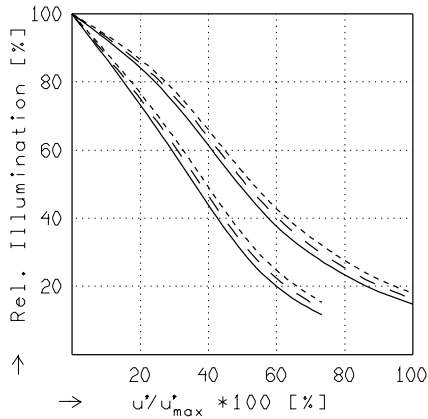
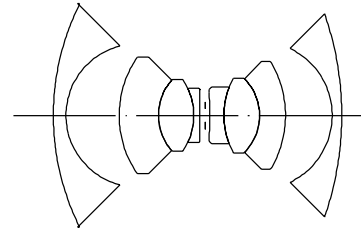

### RELATIVE ILLUMINATION

The relative illumination is shown for the given focal distances or magnifications.

$$f / 5.6 \qquad f / 22.0$$

—	$\beta' = 0.0000$	$u'_{\max} = 112.9$	$00' = \infty$
- -	$\beta' = -0.0500$	$u'_{\max} = 113.1$	$00' = 1618.$
- · -	$\beta' = -0.1000$	$u'_{\max} = 113.3$	$00' = 902.$

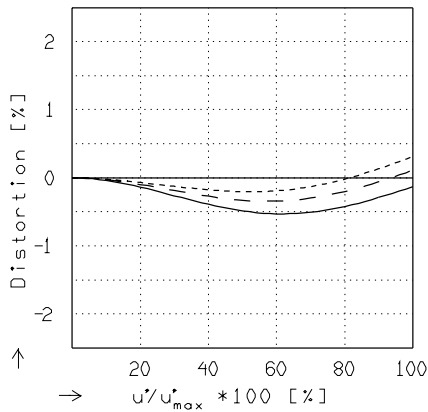

### DISTORTION

Distortion is shown for the given focal distances or magnifications. Positive values indicate pincushion distortion and negative values barrel distortion.

—	$\beta' = 0.0000$	$u'_{\max} = 112.9$	$00' = \infty$
- -	$\beta' = -0.0500$	$u'_{\max} = 113.1$	$00' = 1618.$
- · -	$\beta' = -0.1000$	$u'_{\max} = 113.3$	$00' = 902.$

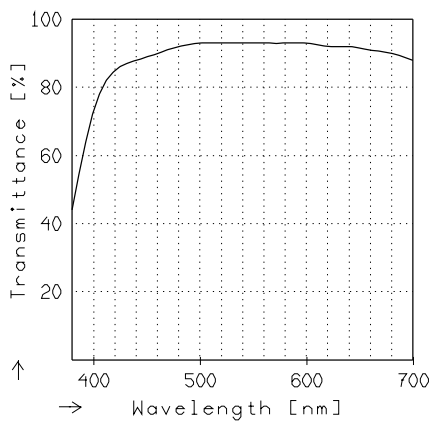

### TRANSMITTANCE

Relative spectral transmittance is shown with reference to wavelength.

Jos. Schneider Optische Werke GmbH  
Ringstrasse 132 55543 Bad Kreuznach Germany

# SUPER-ANGULON XL 5.6/72

MODULATION with reference to the relative image height

Wavelength $\lambda$	[nm]	546	644	588	480	436	405
Spectral weighting	[%]	24.6	18.6	22.1	12.4	15.2	7.1
Spatial frequency R	[1/mm]	5	10	20			
Image- $\emptyset$ f / 5.6	[mm]	165.7					
Image- $\emptyset$ f / 22.0	[mm]	226.0					

radial —  
tangential - -

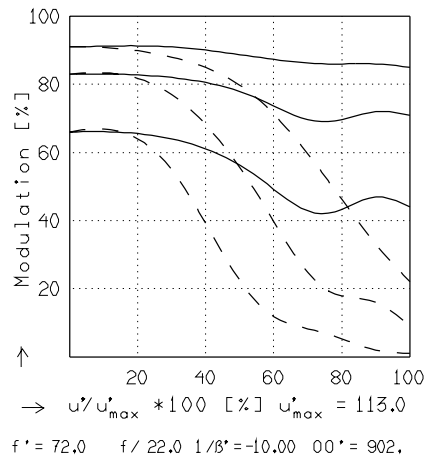
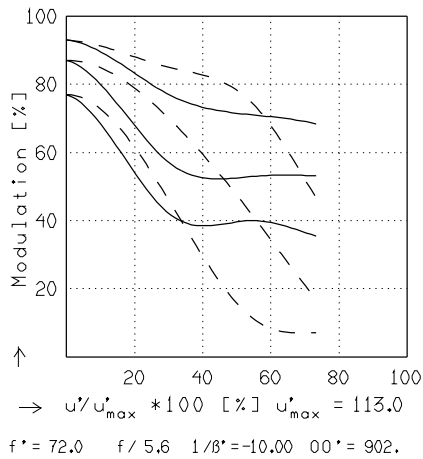
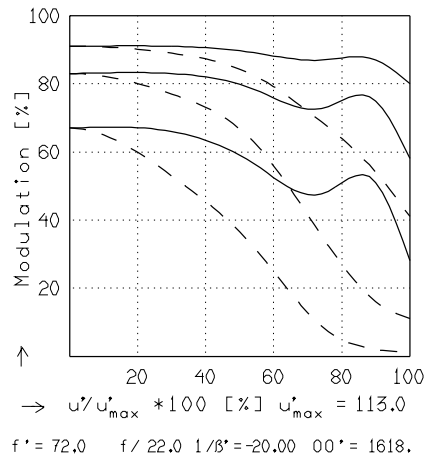
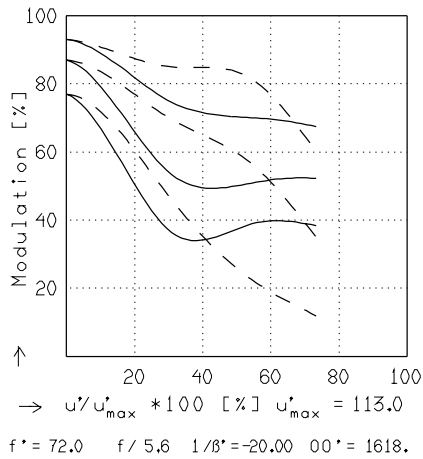
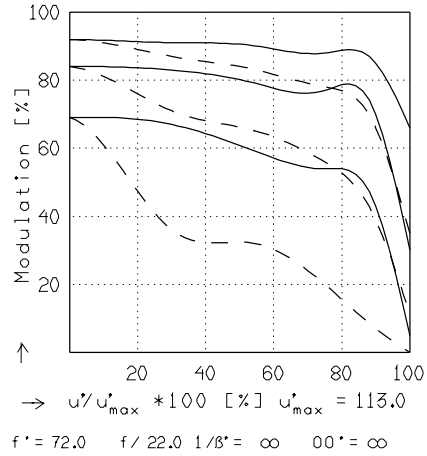
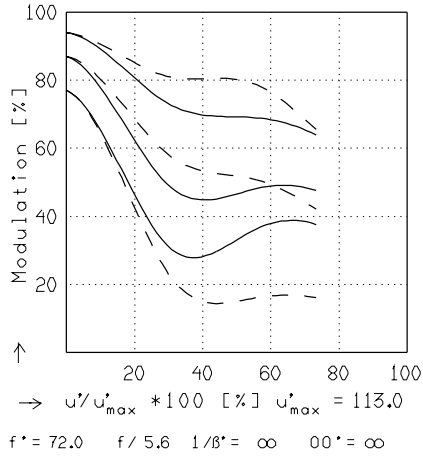

Focusing :  $MTF_{max}$  at  $f / 5.6$  ,  $R = 20$  1/mm,  $u'/u'_{max} = 0$

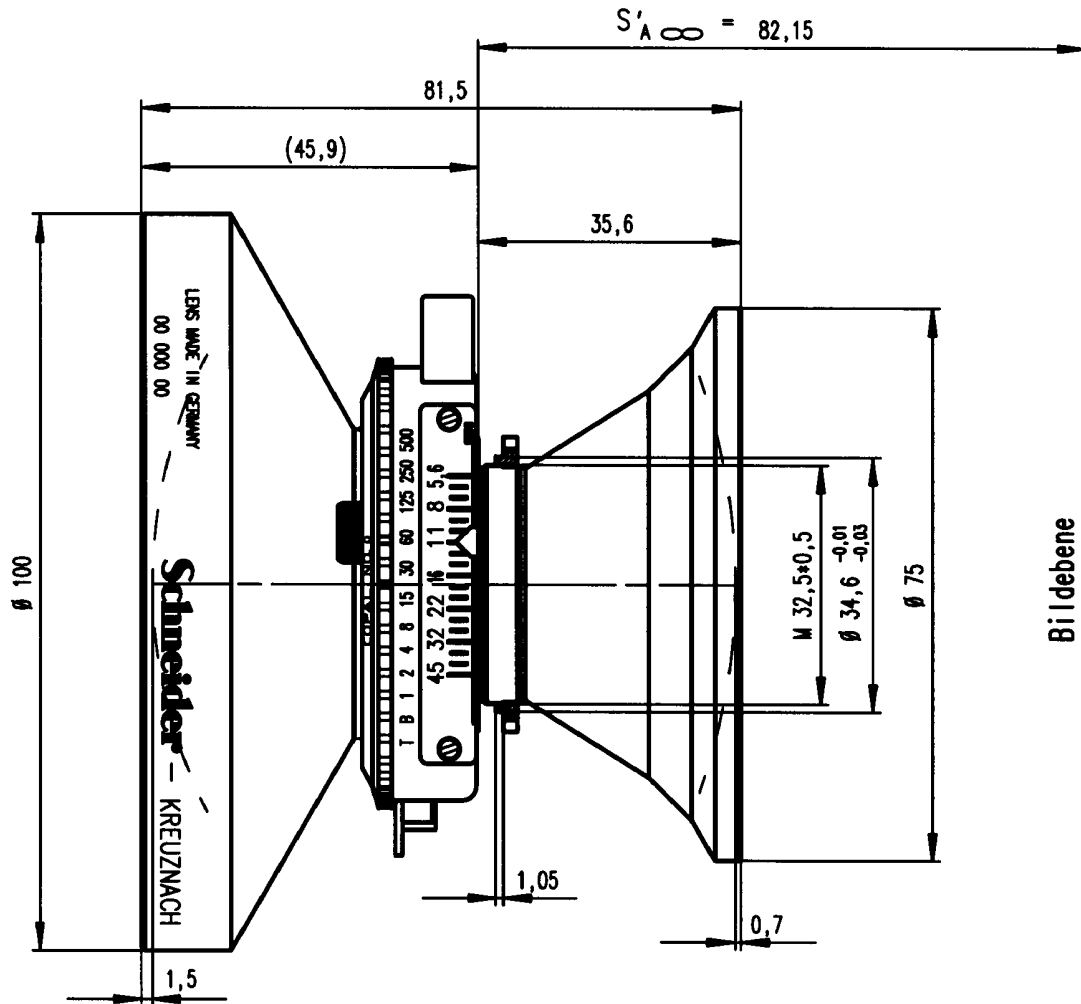

optische Grunddaten									empf. Bildformat	130x180
Linsen/Glieder	8/4			HH'	31,34				Blendenbereich	5,6 - 45
f'	71,98			s <sub>EP</sub>	25,66				Center Filter	<u>IV</u> a/35* u. b/25*
s' <sub>F</sub>	47,31			s' <sub>AP</sub>	-22,33				Filtergewinde	M 95x1
s' <sub>H</sub>	-24,67			S <sub>SK</sub>	79,25				Gewicht	520 g
				k=5,6	k=22				Grundausführung	AN 5672-0001
Bildwinkel								Verschluss	COPAL 0 (Mod. AC 743)	
Bildkreis Ø				165,6      226,0				Blendenbogen A+B	SR56100-0021-U1	
Blendenzahl	5,6	8	11	16	22	32	45	-	Id.Nr.	25587
Blenden Ø	14,07	9,95	7,01	4,94	3,49	2,47	1,75	-	Schutzkappe vorn	SN 223/034-100,0x9,0.01
									Schutzkappe hinten	SN 223/030-075,0x7,0.01

Angaben ohne Einheiten in mm