

Service Manual

ViewSonic VA2226w-1

Model No. VS11803

22" Color TFT LCD Display

(VA2226w-1_SM Rev. 1a Aug. 2007)

ViewSonic 381 Brea Canyon Road, Walnut, California 91789 USA - (800) 888-8583

Copyright

Copyright © 2007 by ViewSonic Corporation. All rights reserved. No part of this publication may be reproduced, transmitted, transcribed, stored in a retrieval system, or translated into any language or computer language, in any form or by any means, electronic, mechanical, magnetic, optical, chemical, manual or otherwise, without the prior written permission of ViewSonic Corporation.

Disclaimer

ViewSonic makes no representations or warranties, either expressed or implied, with respect to the contents hereof and specifically disclaims any warranty of merchantability or fitness for any particular purpose. Further, ViewSonic reserves the right to revise this publication and to make changes from time to time in the contents hereof without obligation of ViewSonic to notify any person of such revision or changes.

Trademarks

Optiquest is a registered trademark of ViewSonic Corporation.

ViewSonic is a registered trademark of ViewSonic Corporation.

All other trademarks used within this document are the property of their respective owners.

Product disposal at end of product life

The lamp in this product contains mercury. Please dispose of in accordance with local, state or federal laws.

Revision History

Revision	SM Editing Date	ECR Number	Description of Changes	Editor
1a	8/16/2007		Initial Release	Jamie Chang

TABLE OF CONTENTS

1. Precautions and Safety Notices	1
2. Specification	4
3. Front Panel Function Control Description	27
4. Circuit Description	32
5. Adjusting Procedure	42
6. Trouble Shooting Flow Chart	53
7. Block Diagrams	61
8. Schematic Diagrams	62
9. PCB Layout Diagrams	67
10. Exploded Diagram And Spare Parts List.....	71
11. Recommended Spare Parts List	74

1. Precautions and Safety Notices

1. SAFETY PRECAUTIONS

This monitor is manufactured and tested on a ground principle that a user's safety comes first. However, improper used or installation may cause damage to the monitor as well as to the user.

WARNINGS:

- This monitor should be operated only at the correct power sources indicated on the label on the rear of the monitor. If you're unsure of the power supply in you residence, consult your local dealer or Power Company.
- Use only the special power adapter that comes with this monitor for power input.
- Do not try to repair the monitor by yourself, as it contains no user-serviceable parts. Only the qualified technician can repair it.
- Do not remove the monitor cabinet. There are high-voltage parts inside that may cause electric shock to human bodies.
- Stop using the monitor if the cabinet is damaged. Have it checked by a service technician.
- Put your monitor only in a lean, cool, dry environment. If it gets wet, unplug the power cable immediately and consult your closed dealer.
- Always unplug the monitor before cleaning it. Clean the cabinet with a clean, dry cloth. Apply non-ammonia based cleaner onto the cloth, not directly onto the glass screen.
- Do not place heavy objects on the monitor or power cord.







2. PRODUCT SAFETY NOTICE

Many electrical and mechanical parts in this chassis have special safety visual inspections and the protection afforded by them cannot necessarily be obtained by using replacement components rated for higher voltage, wattage, etc. Before replacing any of these components read the parts list in this manual carefully. The use of substitute replacement parts, which do not have the same safety characteristics as specified in the parts list, may create shock, fire, or other hazards.

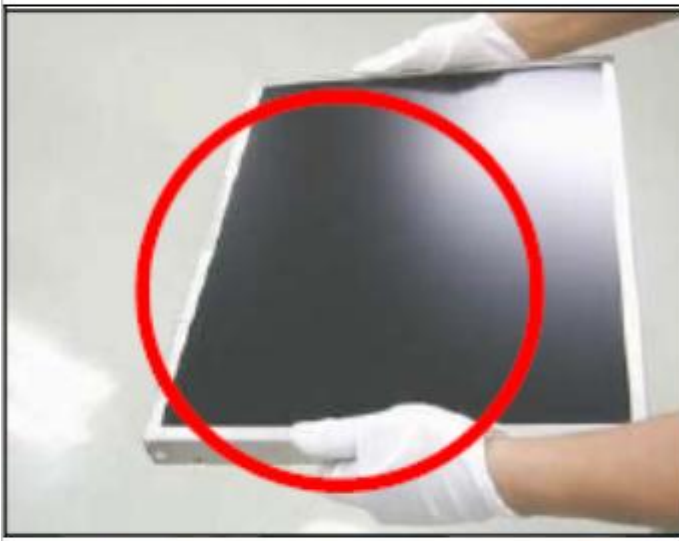
3. SERVICE NOTES

- When replacing parts or circuit boards, clamp the lead wires around terminals before soldering.
- Keep wires away from high voltage, high temperature components and sharp edges.
- Keep wires in their original position so as to reduce interference.
- Adjustment of this product please refers to the user' manual.

4. Handling and Placing Methods

Correct Methods:	Incorrect Methods:
<p>Only touch the metal frame of the LCD panel or the front cover of the monitor. Do not touch the surface of the polarizer</p>	<p>Surface of the LCD panel is pressed by fingers and that may cause "Mura"</p>
	
	
<p>Take out the monitor with cushions</p>	<p>Taking out the monitor by grasping the LCD panel. That may cause "Mura"</p>
	

Place the monitor on a clean and soft foam pad.

Placing the monitor on foreign objects. That could scratch the surface of the panel or cause "Mura"



The panel is placed facedown on the lap. That may cause "Mura".



2. Specification

Product definition and specification

Product Name	ViewSonic VA2226w
Oracle P/N	VA2226W
Model Number	VS11803
OSD Languages	English, French, German, Italian, Spanish, Finnish, Japanese, Russian Simplified Chinese, Traditional Chinese, Korean
TFT LCD Panel and Model #	1 st : INL MT220WW01 V0 2 nd : AUO M220EW01 V0 3 rd : INL MT220W01 V2
Scalar	MST TSUMU58WHJ-LF
Input Signal	Analog x1 / Digital x1
Sync Compatibility	Separate Sync / Composite Sync / SOG
Adapter	Internal Power Board
Power Cable	Yes, refer to APPENDIX B: Power Cable
Analog Cable (1.8 m, black), with PC 2001 and Hot Plug Detect &DDC	Yes (Detached cable; refer the Appendix A)
DVI-D Cable(1.8m, black) with PC 2001	For Region code = P/A/J/K/S units only
Audio Cable(1.8m, black) with PC 2001	Yes
MIC Cable(1.8m, black) with PC 2001	No
USB Cable (V2.0)	No
ViewSonic CD Wizard	Arabic, English, Finnish, Spanish, German, Italian, Japanese, Swedish, Polish, Korean, Portuguese, Russian, Turkish , French, Czech, Hungarian, Simplified Chinese, Traditional Chinese
ViewSonic Quick Start Guide	Greek, Dutch.
PerfectSuite CD	No
Screen Protector Mylar	Yes
Foot Protector plastic	No
Energy start sticker	Yes
Service Insert	For Region code = M units only
Warranty Sticker	For Region code = G units only
Warranty Card	For Region code = G units only
Carton Sticker	For Region code = G units only
PE bag of Carton	For Region code = G units only
Manufacture address sticker	For Region code = G units only

2-1 GENERAL specification

Test Resolution & Frequency	1680x1050@ 60Hz
Test Image Size	Full Size
Contrast and Brightness Controls	Factory Default: Contrast = 70%, Brightness = 100%

2-2 VIDEO INTERFACE

Input Connector (refer the Appendix A)	Analog = DB-15 Digital = DVI-D
Default Input Connector	Defaults to the first detected input
Video Cable Strain Relief	Equal to twice the weight of the monitor for five minutes
Video Cable Connector Pin out	Refer to Appendix A; Compliant DDC/CI
Video Signals	Video RGB (Analog) Separate Sync / Composite Sync / SOG TMDS (Digital)
Video Impedance	75 Ohms (Analog), 100 Ohms (Digital)
Maximum PC Video Signal	950 mV with no damage to monitor
Maximum Mac Video Signal	1250 mV with no damage to monitor
Sync Signals	TTL
DDC/CI	Compliant with version 1.1
Digital link protection	HDCP
Sync Compatibility	Separate Sync / Composite Sync / SOG
Video Compatibility	Shall be compatible with all PC type computers, Macintosh computers, and after market video cards
Resolution Compatibility	Refer to Segment 2-5
Exclusions	Not compatible with interlaced video

2-3 USB INTERFACE

No USB interface

2-4 POWER SUPPLY

Internal Power Supply Part Number	RLPR-025		
Input Voltage Range	90 to 264 VAC		
Input Frequency Range	47 to 63 Hertz		
Short Circuit Protection	Output can be shorted without damage		
Over Current Protection	5A typical at 14.0 VDC		
Leakage Current	3.5mA (Max) at 254VAC / 60Hz		
Efficiency (at 115VAC Full Load)	Typical: 80% Minimum: 75%		
Fuse	Internal and not user replaceable		
Power Output	38 Watts (typ)		
Ripple and Noise	Ripple: <3% Noise: <1%		
Max Input AC Current	1.5 Arms @ 90VAC, 0.75 Arms @180VAC		
Inrush Current (Cold Start)	50 A (max) @ 115VAC 90 A (max) @ 230VAC		
Power Supply Cold Start	Shall start and function properly when under full load, with all combinations of input voltage, input frequency, and operating temperature.		
Power Supply Transient Immunity	Shall be able to withstand an ANSI/IEEE C62.41-1980 6000V 200 ampere ring wave transient test with no damage.		
Power Supply Line Surge Immunity	Shall be able to withstand 1.5 times nominal line voltage for one cycle with no damage.		
Power Supply Missing Cycle Immunity	Shall be able to function properly, without reset or visible screen artifacts, when ½ cycle of AC power is randomly missing at nominal input.		
Power Supply Acoustics	The power supply shall not produce audible noise that would be detectable by the user. Audible shall defined to be in compliance with ISO 7779 (DIN EN27779:1991) Noise measurements of machines acoustics. Power Switch noise shall not be considered.		
Power Saving Operation(Method)	VESA DPMS Signaling		
Power Consumption	Mode	LED	Power Consumption
	On	Blue	38W (typ) 43W (max)
	Active off	Amber	<2W
	Off	Off	<1W
Recovery Time	On Mode = N/A, Active Off < 3 sec		

2-5 ELECTRICAL REQUIREMENT

Horizontal / Vertical Frequency

Horizontal Frequency	24 – 82 kHz
Vertical Refresh Rate	50 – 75 Hz
Maximum Pixel Clock	135 MHz
Sync Polarity	Independent of sync polarity

Timing Table

Timing Table

Item	Timing	Analog			Digital - TMDS	Remark
		Separated	Composite	SOG		
1	640 x 350 @ 70 Hz, 31.5 KHz	✓	✓	✓	✓	DMT
2	640 x 400 @ 60 Hz, 31.5 KHz	✓	✓	✓	✓	
3	640 x 400 @ 70 Hz, 31.5 KHz	✓	✓	✓	✓	
4	640 x 480 @ 50 Hz, 24.7 KHz				✓	
5	640 x 480 @ 60 Hz, 31.5 KHz	✓	✓	✓	✓	DMT
6	640 x 480 @ 67 Hz, 35 KHz	✓	✓	✓	✓	For MAC
7	640 x 480 @ 72 Hz, 37.9 KHz	✓	✓	✓	✓	VESA
8	640 x 480 @ 75 Hz, 37.5 KHz	✓	✓	✓	✓	VESA
9	720 x 400 @ 70 Hz, 31.5 KHz	✓	✓	✓	✓	
10	720 x 480 @ 60 Hz, 31.5 KHz	✓	✓	✓	✓	DTV
11	720 x 576 @ 50 Hz, 31.3 KHz				✓	DTV
12	800 x 600 @ 56 Hz, 35.1 KHz	✓	✓	✓	✓	VESA
13	800 x 600 @ 60 Hz, 37.9 KHz	✓	✓	✓	✓	VESA
14	800 x 600 @ 72 Hz, 48.1 KHz	✓	✓	✓	✓	VESA
15	800 x 600 @ 75 Hz, 46.9 KHz	✓	✓	✓	✓	VESA
16	832 x 624 @ 75 Hz, 49.7 KHz	✓	✓	✓	✓	MAC
17	1024 x 768 @ 50 Hz, 39.6 KHz	✓	✓	✓	✓	
18	1024 x 768 @ 60 Hz, 48.4 KHz	✓	✓	✓	✓	VESA
19	1024 x 768 @ 70 Hz, 56.5 KHz	✓	✓	✓	✓	VESA
20	1024 x 768 @ 75 Hz, 60 KHz	✓	✓	✓	✓	VESA
21	1152 x 864 @ 75 Hz, 67.5 KHz	✓	✓	✓	✓	VESA
22	1152 x 870 @ 75 Hz, 68.7 KHz	✓	✓	✓	✓	For MAC
23	1152 x 900 @ 67 Hz, 62.5 KHz	✓	✓	✓	✓	For SUN
24	1280 x 720 @ 50 Hz, 37.5 KHz	✓	✓	✓	✓	DTV
25	1280 x 720 @ 60 Hz, 45 KHz	✓	✓	✓	✓	DTV
26	1280 x 768 @ 50 Hz, 39.6 KHz	✓	✓	✓	✓	
27	1280 x 768 @ 60 Hz, 47.8 KHz	✓	✓	✓	✓	CVT

28	1280 x 768 @	75 Hz, 60.3 KHz	✓	✓	✓	✓	CVT
29	1280 x 960 @	50 Hz, 49.4 KHz	✓	✓	✓	✓	
30	1280 x 960 @	60 Hz, 59.7 KHz	✓	✓	✓	✓	VESA
31	1280 x 960 @	75 Hz, 75.2 KHz	✓	✓	✓	✓	VESA
32	1280 x 1024 @	50 Hz, 52.7 KHz	✓	✓	✓	✓	
33	1280 x 1024 @	60 Hz, 64 KHz	✓	✓	✓	✓	VESA
34	1280 x 1024 @	75 Hz, 80 KHz	✓	✓	✓	✓	VESA
35	1440 x 900 @	60 Hz 55.9 KHz	✓	✓	✓	✓	VESA
36	1440 x 900 @	75 Hz 70.6 KHz	✓	✓	✓	✓	VESA
37	1600 x 1200 @	60 HZ 75.0 KHz	✓	✓	✓	✓	VESA
38	1680 x 1050 @	60 HZ 65.3 KHz	✓	✓	✓	✓	CVT

*1. Tolerance $\geq \pm 2\text{KHz}$ (if no overlapping issue)

*2. Any timing not in the list, it should display as normal or show on "OUT OF RANGE" OSD message without blanking.

*3. The image quality of 50Hz mode might be worse than 60Hz.

Primary Presets

1680x1050 @ 60Hz

User Presets

Number of User Presets (recognized timings) Available: 10 presets total in FIFO configuration

Changing Modes

- Maximum Mode Change Blank Time for image stability : 5 seconds (Max), excluding "Auto Adjust" time
- Under DOS mode (640 x 350, 720 x 400 & 640 x 400), it should recall factory setting when execute "Auto Adjust"
- The monitor needs to do "Auto Adjust" the first time a new mode is detected (see section "0-Touch™ Function Actions")
- While running Change Mode, Auto Adjust or Memory Recall, the image shall blank





2-6 FRONT PANEL CONTROLS AND INDICATORS

2-6-1 Front Panel Hardware Controls

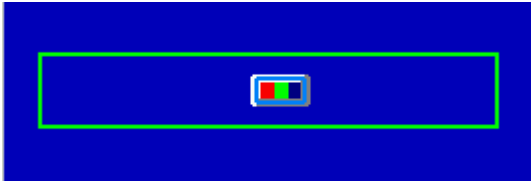



Power Switch (Front Head)	Power Control, soft Power Switch.
Power LED (Front Head)	Blue – ON Amber – Active Off Dark = Soft Power Switch OFF
Front Panel Controls (Head) [⏻][1][2][▲][▼]	[⏻] Power [1] BUTTON 1 [2] Button 2 [▲] UP ARROW BUTTON [▼] DOWN ARROW BUTTON Note: Power Button, Button 1 and Button 2 must be one-shot logic operation. (i.e. there should be no cycling)
Reaction Time	OSD must fully appear within 0.5s after pushing Button 1



2-6-2 Short Cuts Function from the button(s)

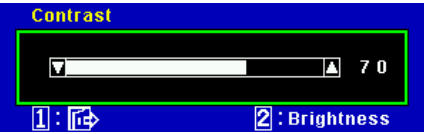

[1]	Main Menu (refer to segment 2-6-3)
[2]	Input toggle (Analog or Digital; refer to Appendix D)
[▼]	To immediately activate Brightness menu. It should be change to Contrast OSD by push button [2] (refer to the Brightness OSD in segment 2-6-3)
[▲]	To immediately activate Contrast menu. It should be change to Brightness OSD by push button [2] (refer to the Contrast OSD in segment 2-6-3)
[▼]+ [▲]	Recall both of Contrast and Brightness to default without OSD message.
[1] + [2]	Toggle 720x400 and 640x400 mode when input 720x400 or 640x400 mode
[1] + [▼] + [▲] (Keep pushing 5 sec)	White Balance 1. It will not shown on user's guide 2. OSD message as below,  (Image = no blanking)
[1] + [▲]	OSD Lock (refer to segment 2-6-4)

[1] + [▼]	Power Lock (refer to segment 2-6-5)
[2] + [▼]	Switch DDC/CI and DDC/2B (DDC/CI enable/disable) and show following message for 3 seconds, When switch to DDC/CI  When switch to DDC/2B 
[▲]	1. Long Press [up] key 3 seconds to switch DCR On/Off, 2. Loop: DCR On <=> DCR Off When switch to DCR ON  When switch to DCR OFF  3. DCR Off in Factory mode. 4. Reset to default when re-power on/off 5. Message will appear only after Hot Key is pressed
[1]+ [⏻]	All reset
No signal + [⏻] + [2]	Burning mode
Signal + [2] + [⏻]	Factory Mode
Remark : All the short cuts function are only available while OSD off	

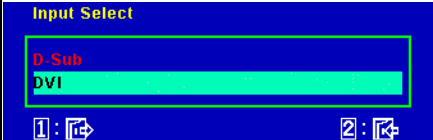
2-6-3 MAIN MENU OSD TABLE

Level 1	Level 2	Level 3
<p>Main Menu</p>  <p>1. Background = blanking 2. The message OSD position is at the center. 3. After auto tune, OSD shall be off 4. Only for analog mode</p>	<p>1. Key button definition: [1]: OSD off [2]: Execute the selected function [Up]: Rolling up the slider (When push the button on the top position, the slider shall go down to the bottom item) [Dn]: Rolling down the slider</p>	
<p>Auto Image Adjust</p>  <p>Contrast/Brightness Jump to Contrast OSD directly</p>	<p>Contrast</p>  <p>1. Adjust range = 0 to 100 2. Default = 70 3. Key button definition: [1] = Back to Main Menu or OSD off (depend on previous status) [2] = Change to Brightness OSD [Up] = Increase the OSD value setting [Dn] = Decrease the OSD value [Up]+[Dn]: Recall to default</p> <p>Brightness</p>  <p>1. Adjust range = 0 to 100 2. Default = 100</p>	

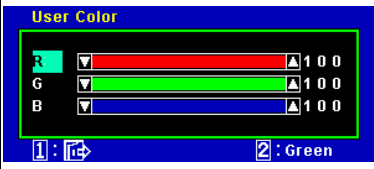
	<p>3. Key button definition:</p> <p>[1] = Back to Main Menu or OSD off (depend on previous status)</p> <p>[2]: Change to Contrast OSD</p> <p>[Up]: Increase the OSD value setting</p> <p>[Dn]: Decrease the OSD value</p> <p>[Up]+[Dn]: Recall to default</p>	
<p>Input Select</p>  <p>1. Show on existing input port by red color</p> <p>2. Key button definition:</p> <p>[1]: Back to previous OSD status</p> <p>[2]: Change to the selected input port</p> <p>[Up]: Move the slider to Analog</p> <p>[Dn]: Move the slider to Digital</p>	<p>Analog</p> <p>Step 1: Turn off OSD.</p> <p>Step 2:</p> <ol style="list-style-type: none"> 1. Target video input port = Analog 2. If signal detected from target port, change to target port. 3. If no signal detected from target port, keep existing input port. <p>Step 3: Show on Input Message OSD at the right-top corner of screen for 1 second.</p>	
	<p>Digital</p> <p>Step 1: Turn off OSD.</p> <p>Step 2:</p> <ol style="list-style-type: none"> 1. Target video input port = Digital 2. If signal detected from target port, change to target port. 3. If no signal detected from target port, keep existing input port. <p>Step 3: Show on Input Message OSD at the right-top corner of screen for 1 second.</p>	
<p>Color Adjust</p>  <p>1. Show on existing input port by red color</p> <p>2. Key button definition:</p> <p>[1]: Back to previous OSD status</p>	<p>sRGB</p> <p>Change Color setting to sRGB</p> <p>9300K</p> <p>Change Color setting to 9300K</p> <p>6500K</p> <p>Change Color setting to 6500K</p> <p>5400K</p> <p>Change Color setting to 5400K</p> <p>User Color</p>	
<p>[2]: Change to the selected color setting</p> <p>[Up]: Move up the slider</p> <p>[Dn]: Move down the slider</p>	<p>Jump to Red OSD directly</p>	<p>Red</p>

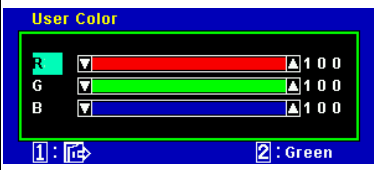
 <p>1. Adjust range = 0 to 100 2. Default = 100 3. Key button definition: [1]: Back to Color Adjust OSD [2]: Jump to Green OSD [Up]: Increase the OSD value setting [Dn]: decrease the OSD value setting</p>
<p>Green</p>  <p>1. Adjust range = 0 to 100 2. Default = 100 3. Key button definition: [1]: Back to Color Adjust OSD [2]: Jump to Blue OSD [Up]: Increase the OSD value setting [Dn]: decrease the OSD value setting</p>
<p>Blue</p>  <p>1. Adjust range = 0 to 100 2. Default = 100 3. Key button definition: [1]: Back to Color Adjust OSD [2]: Jump to Red OSD [Up]: Increase the OSD value setting [Dn]: decrease the OSD value setting</p>

Information

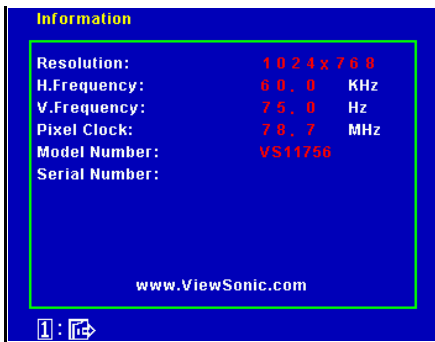

Key button definition:

[1]: Back to Main Menu OSD

Manual Image Adjust

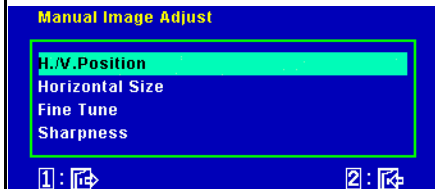

1. Key button definition:

[1]: Back to previous OSD status

[2]: Execute the selected function

[Up]: Rolling up the slider

(When push the button on the top position, the slider shall go down to the bottom item

[Dn]: Rolling down the slider

(When push the button on the bottom position, the slider shall go down to the top item

2. Under Digital mode, all the H./V. Position, Horizontal Size and Fine Tune shall be disabled with gray color. And it should not be selected.

3. Under native mode, Sharpness shall be disabled with gray color. And it should not be selected.

4. When Dynamic Contrast is selected, the right-bottom side description will change to "[2]: /□"

H/V Position

Jump to Horizontal Position OSD directly

Horizontal Position

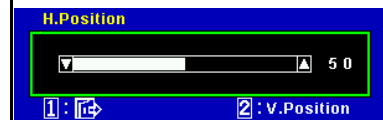

1. Adjust range = 0 to 100

2. Key button definition:

[1]: Back to Manual Image Adjust OSD

[2]: Change to Vertical Position OSD

[Up]: Increase the OSD value setting

[Dn]: Decrease the OSD value

Vertical Position



1. Adjust range = 0 to 100

2. Key button definition:

[1]: Back to Manual Image Adjust OSD

[2]: Change to Horizontal Position OSD

[Up]: Increase the OSD value setting

[Dn]: Decrease the OSD value

Horizontal Size



1. Adjust range = 0 to 100





2. Key button definition:

[1]: Back to Manual Image Adjust OSD

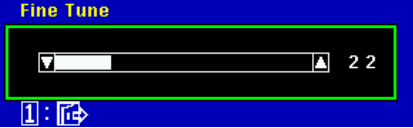

[Up]: Increase the OSD value setting

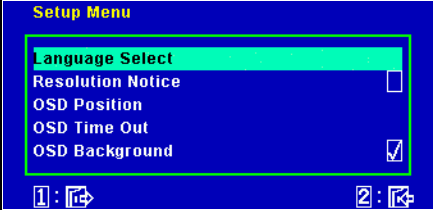
[Dn]: Decrease the OSD value

Fine Tune

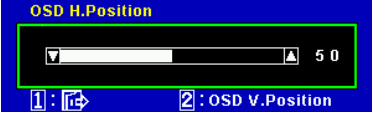
	 <p>1. Adjust range = 0 to 100</p> <p>2. Key button definition:</p> <p>[1]: Back to Manual Image Adjust OSD</p> <p>[Up]: Increase the OSD value setting</p> <p>[Dn]: Decrease the OSD value</p>	
	 <p>1. Adjust range = 0 to 100</p> <p>2. Key button definition:</p> <p>[1]: Back to Manual Image Adjust OSD</p> <p>[Up]: Increase the OSD value setting</p> <p>[Dn]: Decrease the OSD value</p>	
	<p>Dynamic Contrast</p> <p>Swap on and off the Dynamic Contrast function</p>	
<p>Setup Menu</p>  <p>1. Key button definition:</p> <p>[1]: Back to Main Menu OSD</p> <p>[2]: Execute the selected function</p> <p>[Up]: Rolling up the slider</p> <p>(When push the button on the top position, the slider shall go down to the bottom item)</p> <p>[Dn]: Rolling down the slider</p> <p>(When push the button on the bottom position, the slider shall go down to the top item)</p> <p>2. When Resolution Notice / Input Signal Notice / OSD Background / OSD Pivot is selected, the right-bottom side description will change to “[2]: <input type="checkbox"/>/□”</p>	<p>Language Select</p>  <p>1. Show on existing input port by red color</p> <p>2. Key button definition:</p> <p>[1]: Back to previous OSD status</p> <p>[2]: Change to the selected language setting</p> <p>[Up]: Rolling up the slider</p> <p>(When push the button on the top position, the slider shall go down to the bottom item)</p> <p>[Dn]: Rolling down the slider</p> <p>(When push the button on the bottom</p>	<p>English</p> <p>Set OSD language to English and keep in Language Select OSD</p> <p>French</p> <p>Set OSD language to French and keep in Language Select OSD</p> <p>German</p> <p>Set OSD language to German and keep in Language Select OSD</p> <p>Spanish</p> <p>Set OSD language to Spanish and keep in Language Select OSD</p> <p>Italian</p> <p>Set OSD language to Italian and keep in Language Select OSD</p> <p>Finnish</p> <p>Set OSD language to Finnish and keep in Language Select OSD</p> <p>Russian</p> <p>Set OSD language to Russian and keep in</p>

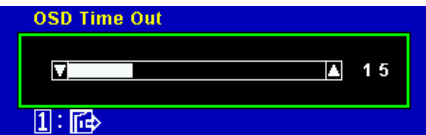
<p>position, the slider shall go down to the top item</p>	<p>Language Select OSD</p> <p>Japanese Set OSD language to Japanese and keep in Language Select OSD</p> <p>Korean Set OSD language to Korean and keep in Language Select OSD</p> <p>Simplified Chinese Set OSD language to Simplified Chinese and keep in Language Select OSD</p> <p>Traditional Chinese Set OSD language to Traditional Chinese and keep in Language Select OSD</p>
<p>Resolution Notice Swap on and off the Resolution Notice function</p>	<p style="background-color: #cccccc;"></p>
<p>OSD Position Jump to OSD H. Position OSD directly</p>	<p>OSD H. Position</p>  <p>1. Adjust range = 0 to 100 2. Default = 50 3. Key button definition: [1]: Back to Setup Menu OSD [2]: Change to OSD V. Position OSD [Up]: Increase the OSD value setting (move OSD right) [Dn]: Decrease the OSD value setting (move OSD left) [Up]+[Dn]: Recall to default value</p> <p>OSD V. Position</p> <p>1. Adjust range = 0 to 100 2. Default = 50 3. Key button definition: [1]: Back to Setup Menu OSD [2]: Change to OSD H. Position OSD [Up]: Increase the OSD value setting (move OSD up) [Dn]: Decrease the OSD value setting</p>

		(move OSD down) [Up]+[Dn]: Recall to default value
	OSD Time Out  <ol style="list-style-type: none"> Adjust range = 5, 15, 30, 60 Default = 15 Key button definition: [1]: Back to Setup Menu OSD [Up]: Increase the OSD value setting [Dn]: Decrease the OSD value setting [Up]+[Dn]: Recall to default value 	5 Set OSD Time Out to 5 Seconds 15 Set OSD Time Out to 15 Seconds 30 Set OSD Time Out to 30 Seconds 60 Set OSD Time Out to 60 Seconds
	OSD Background Swap on and off the OSD Background	
Memory Recall  <ol style="list-style-type: none"> Background = blanking Recall white balance to factory setting Recall all the OSD setting to the default. (exclude the R/G/B in User Color) Show the message OSD position is at the center for 3 seconds. Clean FIFO timing mode buffer Execute Auto Image Adjust <p>Note: Memory Recall should not effect on Mute, Language, Power Lock, User Color Settings or Input Priority</p>		

2-6-4 OSD Lock short cuts function for the buttons

The OSD lock will be activated by pressing the front panel control buttons [1] + [▲] for 10 seconds *1. If the user then tries to access the OSD by pressing any of the buttons a message will appear on the screen for 3 seconds showing "OSD Locked" *2. The OSD lock will be deactivated by pressing the front panel control buttons [1] + [▲] again for 10 seconds*3.

*1 The OSD Lock message as below,



Range = 0 to 10

*2 The OSD Locked message as below,



*3 The OSD Unlock message as below,

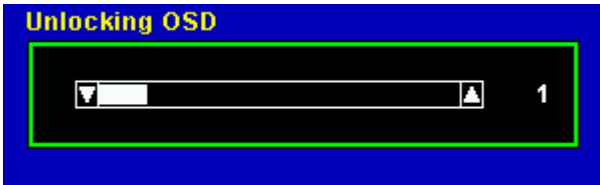

Range = 0 to 10

*4 When the OSD is locked will lock all functions, including "Volume", "Mute" and others.

*5 Status bar indicating OSD Lock or Unlock is in progress and when complete it will indicate "OSD Locked" or "OSD Unlocked" for 3 seconds as below,

OSD Locked



OSD Unlocked



*6 When OSD appears on screen, the OSD Lock/Unlock short cut key will be disabled.

2-6-5 Power Lock short cuts function for the buttons

The Power lock will be activated by pressing the front panel control buttons [1] + [▼] for 10 seconds *1. Locking the power button means that the user won't be able to turn off the LCD while the power button is locked. If the user presses the power button while it is locked, a message will appear on the screen for 3 seconds showing "Power Button Locked" *2. It also means that with the power button locked, the LCD would automatically turn back "On" when power is restored after a power failure. If the power button is not in the locked mode, then power should return to it's previous state when power is restored after a power failure. The Power lock will be deactivated by pressing the front panel control buttons [1] + [▼] again for 10 seconds*3.

*1 The Locking Power Button message as below,

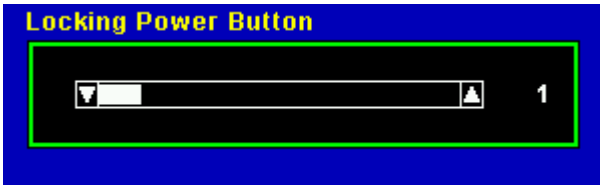

Range = 0 to 10

*2 The Power Button Locked message as below,



*3 The Unlocking Power Button message as below,

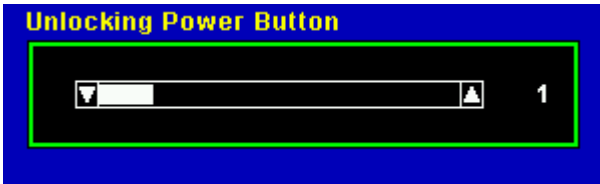

Range = 0 to 10

*4 When the OSD is locked will lock all functions, including "Volume", "Mute" and others.

*5 Status bar indicating OSD Lock or Unlock is in progress and when complete it will indicate "Power Button Locked" or "Button Unlocked" for 3 seconds as below,

Power Button Locked



Power Button Unlocked



*6 When OSD appears on screen, the OSD Lock/Unlock short cut key will be disabled.

2-6-5 Input Signal Notice Actions

1. The Input Signal Notice OSD appears 1 second when power turns on or change input signal.
2. The Input Signal Notice OSD position is on the right-top side of image.

2-6-6 Resolution Notice Actions

1. Resolution Notice OSD should show on screen after changing to non-native mode for 30 sec



2. For auto input select function, it shall meet the requirement in Appendix D.

3. The OSD should disappear after 10 sec or by pushing button [1] or [2]
4. Resolution Notice function should be disabled when push button [2] under Resolution Notice OSD

2-6-7 0-Touch™ Function Actions

1. Execute Auto Image Adjust when new mode detected, and save the settings to buffer for further use
2. It should be reset by Memory Recall function
(Should not reset by power off, power unplug and others)

2-6-8 OSD Auto Save

The OSD shall save new settings when it is turned off by the user or when it times out. There shall not be a separate save

2-6-9 Out of range

While non-defined timing is detected, following OSD message will shows on,



1. If the timing is over spec (Fh, Fv or dot clock), the image shall be blanking, and OSD background shall be non-transparent.
2. If the timing is inspect but not defined, the image shall be non-blanking.

2-6-10 No signal

While no signal is detected, the following OSD message shall shows on 3 seconds then go in to power saving.



OSD Background = Non-transparent
Image = Blanking

Factory Defaults

Item	Defaults	Item	Defaults
Contrast	70%	Input Priority	N/A
Brightness	100%	Resolution Notice	On
Color Temperature	6500K	Volume	50%
Sharpness	100%	Balance	N/A
OSD H. Position	50%	Treble	N/A
OSD V. Position	50%	Bass	N/A
OSD Time Out	15	720x400 / 640x400	720x400
OSD Background	On	DCR	Enable

2-7 AUDIO INTERFACE (SPEAKER SPECIFICATION)

No Audio function

2-8 TFT LCD PANEL

Panel Source Identify

The panel code (refer to segment 2-16) should be shown on following position,

- (1) The lower right side of ID label. (see Figure 2)
- (2) The lower right side of UPC label. (see Figure 3)
- (3) The F/W version sticker or silkscreen on main board.

Panel Characteristics :

1st Source Panel

Model number	INL MT220WW01 V0
Type	Active Matrix TFT, TN technology
Active Size	22" Wide (473.76mm x 296.1mm)
Pixel Arrangement	RGB Vertical Stripe
Pixel Pitch	0.282 mm
Glass Treatment	Anti-Glare, Hard coating (3H)
# of Backlights	4 CCFL
Backlight Life	40000 Hrs (Min)
Luminance (Center) – CT = 6500K, Contrast/ Brightness = Max	300 cd/m2 (Typ after 30 minute warm up) 250cd/m2 (Min after 30 minute warm up)
Brightness Uniformity (13 points)	80 % (Typ) / 75 % (Min)
Contrast Ratio	1000 :1 (Typ) 700:1 (Min)
Color Depth	16.7 million colors (6+2 bit Hi FRC panel)
Horizontal Viewing Angle	170 degrees (Typ) / 150 degrees (Min) @ CR>10
Vertical Viewing Angle	160 degrees (Typ) / 140 degrees (Min) @ CR>10
Response Time	On-Off
10%-90% @ Ta=25°C	5ms (Typ) / 10ms (Max)
Mercury	3.0 mg per lamp
Panel Defects	Please see Panel Quality Specifications.

*Over 50% units of shipment shall be equal or better than the Typical value above.

2nd Source Panel

Model number	AUO M220EW01 V0
Type	Active Matrix TFT, TN technology
Active Size	22" Wide (473.76mm x 296.1mm)
Pixel Arrangement	RGB Vertical Stripe
Pixel Pitch	0.282 mm
Glass Treatment	Anti-Glare, Hard coating (3H)
# of Backlights	4 CCFL
Backlight Life	40000 Hrs (Min)
Luminance (Center) – CT = 6500K, Contrast/ Brightness = Max	300 cd/m2 (Typ after 30 minute warm up) 250cd/m2 (Min after 30 minute warm up)
Brightness Uniformity (13 points)	80 % (Typ) / 75 % (Min)
Contrast Ratio	1000 :1 (Typ) 800:1 (Min)
Color Depth	16.7 million colors (6+2 bit Hi FRC panel)
Horizontal Viewing Angle	170 degrees (Typ) / 160 degrees (Min) @ CR>10
Vertical Viewing Angle	160 degrees (Typ) / 150 degrees (Min) @ CR>10
Response Time	On-Off
10%-90% @ Ta=25°C	5ms (Typ) / 8ms (Max)
Mercury	3.0 mg per lamp
Panel Defects	Please see Panel Quality Specifications.

*Over 50% units of shipment shall be equal or better than the Typical value above.

3rd Source Panel

Model number	INL MT220WW01 V2
Type	Active Matrix TFT, TN technology
Active Size	22" Wide (473.76mm x 296.1mm)
Pixel Arrangement	RGB Vertical Stripe
Pixel Pitch	0.282 mm
Glass Treatment	Anti-Glare, Hard coating (3H)
# of Backlights	4 CCFL
Backlight Life	40000 Hrs (Min)
Luminance (Center) – CT = 6500K, Contrast/ Brightness = Max	300 cd/m2 (Typ after 30 minute warm up) 250cd/m2 (Min after 30 minute warm up)
Brightness Uniformity (13 points)	80 % (Typ) / 75 % (Min)
Contrast Ratio	1000 :1 (Typ) 700:1 (Min)
Color Depth	16.7 million colors (6+2 bit Hi FRC panel)
Horizontal Viewing Angle	170 degrees (Typ) / 150 degrees (Min) @ CR>10
Vertical Viewing Angle	160 degrees (Typ) / 140 degrees (Min) @ CR>10
Response Time	On-Off
10%-90% @ Ta=25°C	5ms (Typ) / 10ms (Max)
Mercury	3.0 mg per lamp
Panel Defects	Please see Panel Quality Specifications.

*Over 50% units of shipment shall be equal or better than the Typical value above.

EDID data

Time: 11:23:00

Date: Tue Jun 05, 2007

VIEWSONIC CORPORATION
EDID Version # 1, Revision # 3
DDCTest For: ViewSonic VA2226w

EDID Block 0, Bytes 0-127

128 BYTES OF EDID CODE:

	0	1	2	3	4	5	6	7	8	9
0	00	FF	FF	FF	FF	FF	FF	00	5A	63
10	20	51	01	01	01	01	01	11	01	03
20	80	31	1D	78	2E	DC	55	A3	59	48
30	9E	24	11	50	54	BF	EF	80	B3	00
40	A9	40	81	80	81	40	71	4F	01	01
50	01	01	01	01	21	39	90	30	62	1A
60	27	40	68	B0	36	00	EF	23	11	00
70	00	1C	00	00	00	FF	00	51	51	4B
80	30	37	30	31	30	30	30	30	31	0A
90	00	00	00	FD	00	32	4B	1E	52	11
100	00	0A	20	20	20	20	20	20	00	00
110	00	FC	00	56	41	32	32	32	36	77
120	0A	20	20	20	20	20	00	8E		

- (08-09) ID Manufacturer Name _____ = VSC
- (11-10) Product ID Code _____ = 5120
- (12-15) Last 5 Digits of Serial Number _____ = Not Used
- (16) Week of Manufacture _____ = 01
- (17) Year of Manufacture _____ = 2007
- (10-17) Complete Serial Number _____ = See Descriptor Block
- (18) EDID Version Number _____ = 1
- (19) EDID Revision Number _____ = 3
- (20) VIDEO INPUT DEFINITION:
Digital Signal
Non - VESA DFP 1.x Compatible
- (21) Maximum Horizontal Image Size _____ = 490 mm
- (22) Maximum Vertical Image Size _____ = 290 mm

(23) Display Gamma _____ = 2.20

(24) Power Management and Supported Feature(s):
Active Off/Very Low Power, Standard Default Color Space,
Preferred Timing Mode
Display Type = R/G/B Color

(25-34) CHROMA INFO:
Red X - 0.640 Green X - 0.284 Blue X - 0.142 White X - 0.313
Red Y - 0.349 Green Y - 0.617 Blue Y - 0.067 White Y - 0.329

(35) ESTABLISHED TIMING I:
720 X 400 @ 70Hz (IBM,VGA)
640 X 480 @ 60Hz (IBM,VGA)
640 X 480 @ 67Hz (Apple,Mac II)
640 X 480 @ 72Hz (VESA)
640 X 480 @ 75Hz (VESA)
800 X 600 @ 56Hz (VESA)
800 X 600 @ 60Hz (VESA)

(36) ESTABLISHED TIMING II:
800 X 600 @ 72Hz (VESA)
800 X 600 @ 75Hz (VESA)
832 X 624 @ 75Hz (Apple,Mac II)
1024 X 768 @ 60Hz (VESA)
1024 X 768 @ 70Hz (VESA)
1024 X 768 @ 75Hz (VESA)
1280 X 1024 @ 75Hz (VESA)

(37) Manufacturer's Reserved Timing:
1152 X 870 @ 75Hz (Apple,Mac II)

(38-53) Standard Timing Identification:
1680 X 1050 @60Hz
1600 X 1200 @60Hz
1280 X 1024 @60Hz
1280 X 960 @60Hz
1152 X 864 @75Hz
Not Used
Not Used
Not Used

(54-71) Detailed Timing / Descriptor Block 1:
1680x1050 Pixel Clock: 146.25 MHz

Horizontal Image Size: 495 mm	Vertical Image Size: 291 mm
Refreshed Mode: Non-Interlaced	Normal Display - No Stereo

Horizontal:

Active Time: 1680 pixels

Blanking Time: 560 pixels

Sync Offset: 104 pixels

Sync Pulse Width: 176 pixels

Border: 0 pixels

Frequency: 65.29 KHz

Vertical:

Active Time: 1050 lines

Blanking Time: 39 lines

Sync Offset: 3 lines

Sync Pulse Width: 6 lines

Border: 0 lines

Frequency: 59.95 Hz

Digital Separate, Horizontal Polarity (-) Vertical Polarity (+)

(72-89) Detailed Timing / Descriptor Block 2:

Monitor Serial Number:

QQK070100001

(90-107) Detailed Timing / Descriptor Block 3:

Monitor Range Limits:

Min Vertical Freq - 50 Hz

Max Vertical Freq - 75 Hz

Min Horiz. Freq - 30 KHz

Max Horiz. Freq - 82 KHz

Pixel Clock - 170 MHz

Secondary GTF - Not Supported

(108-125) Detailed Timing / Descriptor Block 4:

Monitor Name:

VA2226w

(126) No Extension EDID Block(s)

(127) CheckSum OK

Adjusting the Screen Image

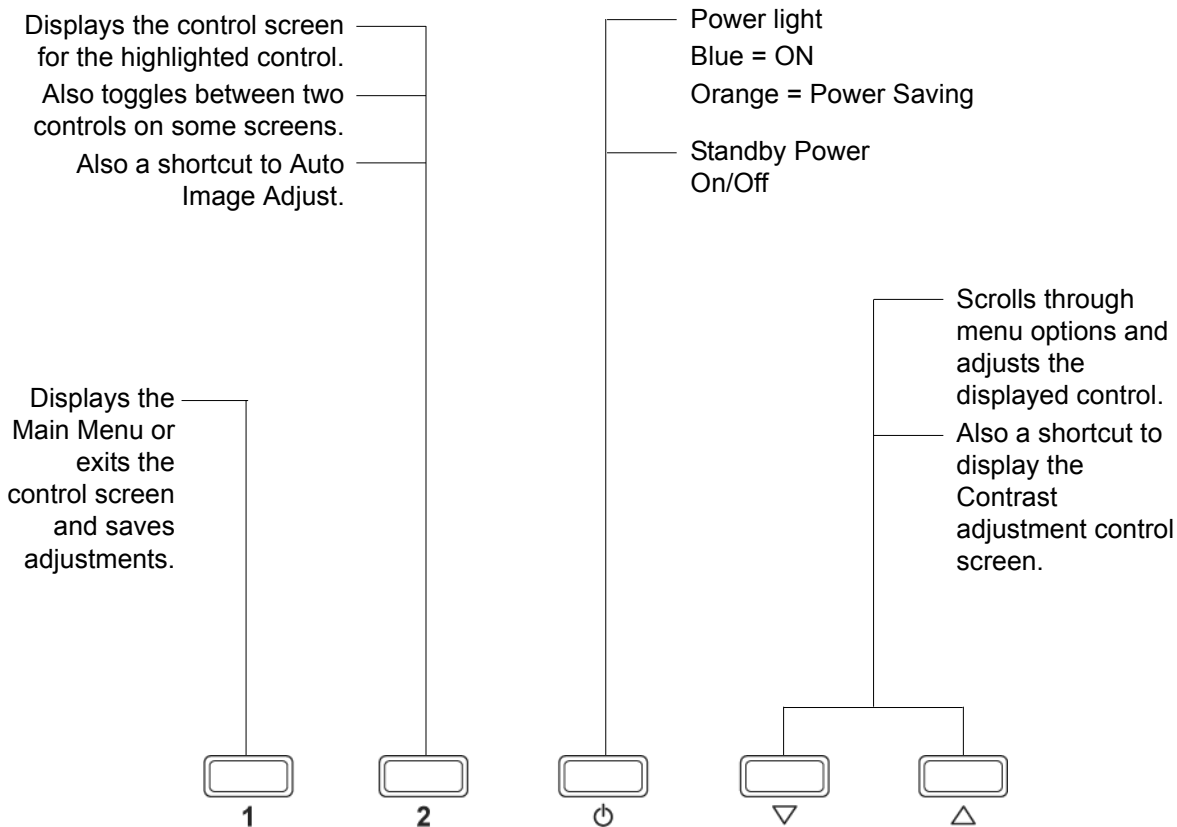
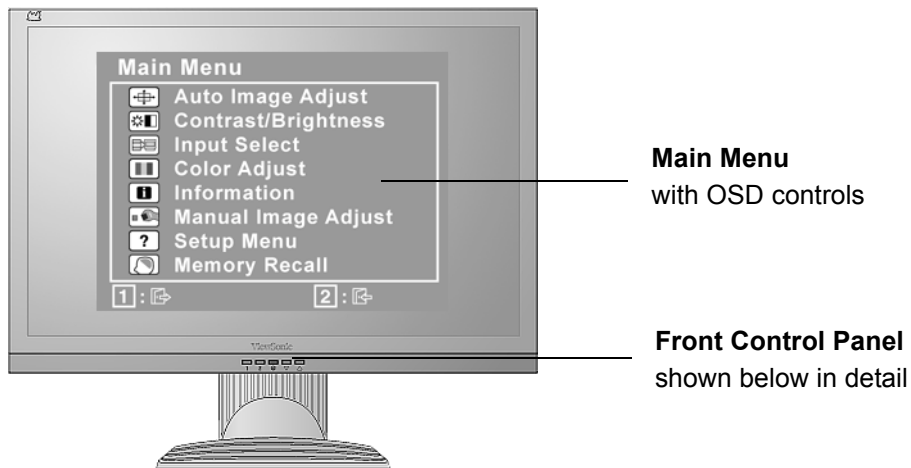

Do the following to adjust the display setting:

1. To display the Main Menu, press button [1].



NOTE: All OSD menus and adjustment screens disappear automatically after about 15 seconds. This is adjustable through the OSD timeout setting in the setup menu.

2. To select a control to adjust, press ▲ or ▼ to scroll up or down in the Main Menu.
3. After the desired control is selected, press button [2]. A control screen like the one shown below appears.



The line at the bottom of the screen shows the current functions of buttons 1 and 2: Exit or select the Brightness control.





4. To adjust the control, press the up ▲ or down ▼ buttons.
5. To save the adjustments and exit the menu, press button [1] *twice*.

The following tips may help you optimize your display:

- Adjust the computer's graphics card so that it outputs a 1680 x 1050 @ 60Hz video signal to the LCD display. (Look for instructions on “changing the refresh rate” in the graphics card's user guide.)
- If necessary, make small adjustments using H. POSITION and V. POSITION until the screen image is completely visible. (The black border around the edge of the screen should barely touch the illuminated “active area” of the LCD display.)

Main Menu Controls

Adjust the menu items shown below by using the up ▲ and down ▼ buttons.

Control	Explanation
	<p>Auto Image Adjust automatically sizes, centers, and fine tunes the video signal to eliminate waviness and distortion. Press the [2] button to obtain a sharper image.</p> <p>NOTE: Auto Image Adjust works with most common video cards. If this function does not work on your LCD display, then lower the video refresh rate to 60 Hz and set the resolution to its pre-set value.</p>
	<p>Contrast adjusts the difference between the image background (black level) and the foreground (white level).</p>
	<p>Brightness adjusts background black level of the screen image.</p>
	<p>Input Select toggles between inputs if you have more than one computer connected to the VA2226w.</p>

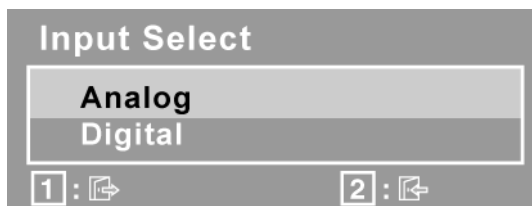

	<p>Color Adjust provides several color adjustment modes, including preset color temperatures and a User Color mode which allows independent adjustment of red (R), green (G), and blue (B). The factory setting for this product is 6500K (6500 Kelvin).</p>
---	---

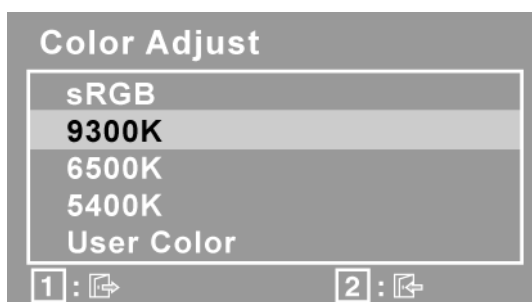

sRGB-This is quickly becoming the industry standard for color management, with support being included in many of the latest applications. Enabling this setting allows the LCD display to more accurately display colors the way they were originally intended. Enabling the sRGB setting will cause the Contrast and Brightness adjustments to be disabled.

9300K-Adds blue to the screen image for cooler white (used in most office settings with fluorescent lighting).

6500K-Adds red to the screen image for warmer white and richer red.

5400K-Adds green to the screen image for a darker color.

User Color Individual adjustments for red (R), green (G), and blue (B).

1. To select color (R, G or B) press button [2].

2. To adjust selected color, press▲and▼.

Important: If you select RECALL from the Main Menu when the product is set to a Preset Timing Mode, colors return to the 6500K factory preset.



Information displays the timing mode (video signal input) coming from the graphics card in the computer, the LCD model number, the serial number, and the ViewSonic® website URL. See your graphics card’s user guide for instructions on changing the resolution and refresh rate (vertical frequency).

NOTE: VESA 1680 x 1050 @ 60Hz (recommended) means that the resolution is 1680 x 1050 and the refresh rate is 60 Hertz.

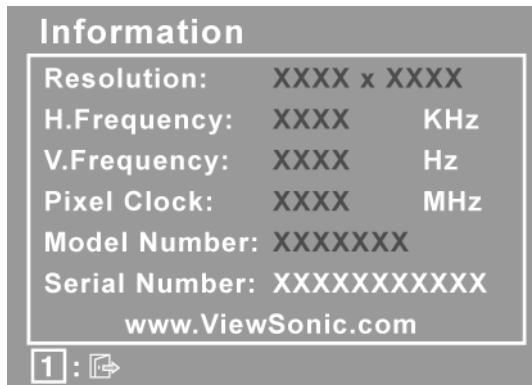

Manual Image Adjust displays the Manual Image Adjust menu.

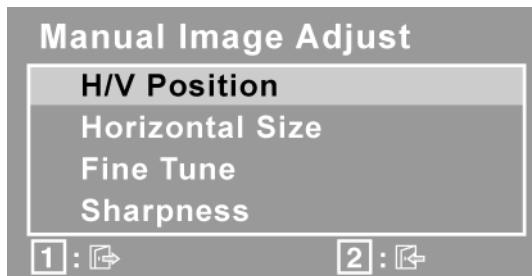

H./V. Position (Horizontal/Vertical Position) moves the screen image left or right and up or down.

H. Size (Horizontal Size) adjusts the width of the screen image.

Fine Tune sharpens the focus by aligning text and/or graphics with pixel boundaries.

NOTE: Try Auto Image Adjust first.

Sharpness adjusts the clarity and focus of the screen image.



Setup Menu displays the menu shown below:

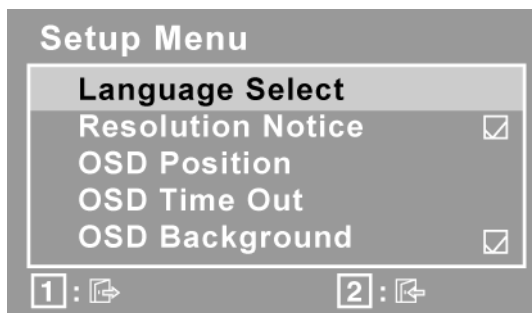

Language Select allows the user to choose the language used in the menus and control screens.

Resolution Notice advises the optimal resolution to use.

OSD Position allows the user to move the OSD menus and control screens.

OSD Timeout sets the length of time the OSD screen is displayed. For example, with a “15 second” setting, if a control is not pushed within 15 seconds, the display screen disappears.

OSD Background allows the user to turn the OSD background On or Off.



Memory Recall returns the adjustments back to factory settings if the display is operating in a factory Preset Timing Mode listed in the Specifications of this manual.

Exception: This control does not affect changes made with the User Color control, Language Select or Power Lock setting.

4. Circuit Description

1. Switching Mode Power Supply

1.1 AC Current Input Circuit

P801 is a connector for connecting AC Power. F801 is a fuse to protect all the circuit. AC input voltage is from 90V to 264V. R801 and R802 joined between two inputting main circuit to prevent man from shock. L801 is used to clear up low frequency wave. C801 and C802 are used to discharge the waves that L801 produced. High frequency waves are damped by C801 and C802. D801 is a rectifier which composed of 4 build-in diodes, it inverts AC to DC.

1.2 High Voltage to Low Voltage Control Circuit

C804 is used to smooth the waveform from rectifier. IC802 is a highly integrated PWM controller, which control the power MOSFET Q804. When rectified DC high voltage is applied to the DRAIN pin during start-up, the MOSFET is off initially, and the capacitor C807 be charged through D802,R803 and the HV pin of IC802,when the voltage VCC reaches the threshold level 12.8V,IC 802 start up and create a PWM signal to control the power MOSFET, then energy is transferred to secondary terminal through the transformer T801,the auxiliary voltage 12V and the output voltage 5V/14V be created ,the auxiliary voltage supply a continue current to IC802,the level of output voltage is feedback to FB pin of IC802 through R823,R824,R822,IC803 and IC803 witch control the duty of the PWM signal, then all the convert circuit go to a stable operating station.

R805 R806 R835 ZD801 ZD806 and Q806 formed a under input voltage protection circuit , only the input AC voltage over the threshold level approximately 63V AC, the switch Q801 can be on and then the auxiliary voltage can supply a continue current to IC802;R808,R807,R836,R812,R815,R836,D806 and Q805 formed a over line current protection circuit witch limited the input power under approximately 63W. ZD805 will be on when the output voltage is too high or the feedback circuit open, the current will drive transistor Q805 open through R830,D814 and made IC802 off the PWM waveform; the high voltage spike created by transformer's primary winding during the transistor turn off will be consumed through D804 R813 R814 and C806, This will prevent MOSFET which built-in IC802 from being damaged under large current impulse and voltage spike.

1.3 DC_5V and DC_14V Output Circuit

For DC 5V, D808 is used to rectify the inducted current. R817 and C815 are used to store energy when current is reversed. The parts including C824,C818,C822 and L803 are used to smooth the current waves.

For DC 14V, D807 is used to rectify the inducted current. R816 and C814 are used to store energy when current is reversed. The parts including C816,C817,C819 and L802 are used to smooth the current waves.

1.4 Feedback and OVP Protect Circuit

Pin R of IC803 is supplied 2.5V stable voltage. It is connected to 5V and 14V output through

R823, R824 and R822. R823 R824 and R822 are output sampling resistor. When the sampling voltage more than 2.5V or less than 2.5V, feedback current of IC802 will change, this can change the voltage from transformer T801.

For output OVP, ZD803,ZD804 and ZD805 are zener diode, when the voltage add to the zener up to their's rating voltage 5.6V, 3.9V or 20V, the zener's leakage current cause R828 voltage become up to 0.7V, Q803 is triggered and OVP starts. The collector current of Q803 is used to make build-in diode light. FB Current of IC802 will be changed; it can change the output voltage from T801.

-

2. Inverter Circuit

2.1 Low voltage to high voltage circuit

14VDC provides the power for IC501; the control signals Brightness and ON/OFF come from I/F board. ON/OFF signal connect to pin8 of IC501 and makes IC501 enable. Brightness signal connect to pin7 of IC501 and regulates the panel brightness, R524, R529, C505 make up a network of delaying time circuit and R528, R523, R524 make up a divided voltage network, C504 is used to dump noise. The operation frequency is determined by the external Resistor R522 and capacitor C529 connected to pin5 of IC501. BURST MODE regulated dimming frequency is determined by the external resistor R527 and capacitor C506 connected to pin6 of IC501. C502 is used for soft start and compensation, C502, C528 are used for dump noise.

The output drives, include NDR4, NDRV2, PDRV3, PDRV1 (pins1, 3, 15, 16 respectively) output square pulses to drive MOSFET U501, U502, and each of U501, U502 is consist of a N channel MOSFET and a P channel MOSFET. U501 and U502 work as full-bridge topology, it is high efficient, zero voltage switching.

During start up, VSEN (pin9) senses the voltage at the transformer secondary. When VSEN reaches 3.0V, the output voltage is regulated. If no current is sensed approximately 1.5 seconds IC501 shunt off.

The current flowing through CCFL is sensed and regulated through sense resistor R509, R511. The feedback voltage through R506, R507, C508 connected to Pin11 (ISEN), then compared with a reference voltage (1.5V) via a current amplifier, resulting in PWM drive outputs to full-bridge switches.

2.2 Protection circuit

Over Voltage Protection: R501and R502 are connected in high voltage output connector, the divided AC voltage is inverted DC voltage through D508, R505 and C507are used to rectify wave & dump noise. Then the voltage signal reaches Pin9 VSEN of IC501, when the voltage changes, build-in PWM of IC501 will adjust output voltage.

Open Lamp Protection: In normal operation, the resistors R510, R511, R512, R509 are sensed a high level AC voltage, the AC signal IS1 invert DC voltage through D509, R515, C533, and the high level DC voltage reaches the gate pin of Q502, similarly, the gate pin of Q503, Q504,

Q505 has high level DC voltage. So the gate pin of Q501 has a low level voltage, and the IC501 is normal operation. Once one of signal OP1,OP2,OP3,OP4 is low, the voltages of Q501 gate pin is high level, and make the voltage of ISEN low level, the IC501 will be shunt down.

3. I/F Circuit

3.1 Power Supply

- +5V is converted to 3V3(U103) and 3V3 is converted to 1V8 by special circuit.
- +5V is fed to LVDS panel via Q101.

3.2 Control Signals Output

- on_BACKLIGHT signal from TSUM56AK pin20 is reversed as ON/OFF signal via Q108 to control backlight on/off. The backlight keeps on while ON/OFF signal is low level .
- adj_BACKLIGHT signal from TSUM56AK pin21 controls backlight brightness.

3.3 VGA Input

- Red,Green,Blue input signals from CN101 #1,#2,#3 enter into TSUM56AK analog input terminals #59,#56,#54 via C101,C102,C103 and then are processed.BAV99 (D102/D104/D106) are ESD protector to prevent IC from ESD.R101/102/103 and R105/106/107 are matching resistance.
- Signal DDC_CLK (series clock) from CN102#15 passes through ZD104 for over voltage protection, and then goes into EDID EEPROM IC U101 #6.
- Signal DDC_DAT (series data) from CN102#12 passes through ZD105 for over voltage protection, and then goes into EDID EEPROM IC U101 #5.
- Signal TTL vertical sync. (Vsync) from CN102 #14 passes through ZD101 (for over voltage protection),R115,R117 and C112 and then goes into IC TSUM56AK#64
- Signal TTL horizontal sync. (Hsync) from CN102 #13 passes through ZD103(for over voltage protection),FB117,R114,C116,R116 and then goes into IC TSUM56AK#63.
- CN101 #5 is defined as VGA cable detect pin, this detector realize via R111,R112 and U105 (TSUM56AK) #69, When cable plug in, DET_VGA is low level. D109 is ESD protector.
- U101VCC is supplied by PC5V from CN101 #9 or by VCC3.3.
- U101 is an EEPROM IC,VGA EDID data is saved in it.

3.4 Scalar & MCU

- U105 (TSUM56AK) is a scalar IC with MCU.
- U105 #105~#114 and #118~#127output 8 bit LVDS digital data to panel control circuit through CN105.
- U106 is a flash memory IC for program.
- U107 is a EEPROM IC.

3. Support Timing Table

This unit can support $F_H=31.5\sim 84$ KHz, $F_v=56\sim 86$ Hz and WXGA+ display modes as below:

Resolution	H-Freq. (kHz)	V-Freq. (Hz)	Dot Clock (MHz)	Mode
640 x 480	31.5	60.0	25.175	VESA Standard
	37.9	72.0	31.500	
	37.5	75.0	31.500	
800 x 600	35.1	56.0	36.000	
	37.9	60.0	40.000	
	48.1	72.0	50.000	
	46.9	75.0	49.500	
1024 x 768	48.4	60.0	65.000	
	56.5	70.0	75.000	
	60.0	75.0	78.750	
1152 x 864	67.5	75.0	108.000	
1280 x 960	60.0	60.0	108.000	
1280 x 1024	64.0	60.0	108.000	
	80.0	75.0	135.000	
1400 x 1050	65.3	60.0	121.750	
	82.5	75.0	136.000	
1440 x 900	59.9	60.0	106.500	
	75.0	75.0	136.750	
720 x 400	31.5	70.0	28.300	US Text
640 x 480	35.0	66.7	30.200	Power Macintosh series
832 x 624	49.7	74.6	57.300	
1024 x 768	60.2	75.0	80.000	
1152 x 870	68.7	75.0	100.000	
1280 x 1024	64.0	60.0	108.000	
	80.0	75.0	135.000	
1024 x 768	48.3	60.0	64.130	Sun Ultra series
	53.6	66.0	70.400	
	56.6	70.0	74.250	
1152 x 900	61.8	66.0	94.880	
	71.8	76.2	108.230	
1280 x 1024	71.7	67.2	117.010	
	81.1	76.0	134.990	
1280 x 800	49.7	60.0		Industrial Standard
	58.4	70.0		

	60.2	72.0	
	62.7	75.0	

- Note:
1. Non-interlace signals only (An interlace signal cannot be display)
 2. Please refer to F/W specification for more detail
 3. Each frequency of Power Macintosh and Sun Ultra is a reference value

4. D-SUB Connector Pin Assignment

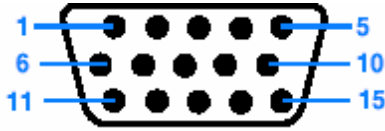

Pin	Symbol	Pin	Symbol	Pin	Symbol
1	Red+	6	Red_GND	11	GND
2	Green+	7	Green_GND	12	DDC_DAT
3	Blue+	8	Blue_GND	13	Hsync
4	NC	9	5V_VGA	14	Vsync
5	Cable Detect	10	GND	15	DDC_CLK

5. CN103 (LVDS interface)

Pin No	Symbol	Description	Pin No	Symbol	Description
1	RxO0-	LVDS Differential data input Channel 0(-)	16	RxE1+	LVDS Differential data input Channel 1(+)
2	RxO0+	LVDS Differential data input Channel 0(+)	17	GND	Ground
3	RxO1-	LVDS Differential data input Channel 1(-)	18	RxE2-	LVDS Differential data input Channel 2(-)
4	RxO1+	LVDS Differential data input Channel 1(+)	19	RxE2+	LVDS Differential data input Channel 2(+)
5	RxO2-	LVDS Differential data input Channel 2(-)	20	RxEC-	LVDS Differential Clock input (-)
6	RxO2+	LVDS Differential data input Channel 2(+)	21	RxEC+	LVDS Differential Clock input (+)
7	GND	Ground	22	RxE3-	LVDS Differential data input Channel 3(-)
8	RxOC-	LVDS Differential Clock input (-)	23	RxE3+	LVDS Differential data input Channel 3(+)
9	RxOC+	LVDS Differential Clock input (+)	24	GND	Ground
10	RxO3-	LVDS Differential data input Channel 3(-)	25	GND	Ground
11	RxO3+	LVDS Differential data input Channel 3(+)	26	GND	NC
12	RxE0-	LVDS Differential data input Channel 0(-)	27	GND	Ground
13	RxE0+	LVDS Differential data input Channel 0(+)	28	VCC	Power supply (+5.0V)
14	GND	Ground	29	VCC	Power supply (+5.0V)
15	RxE1-	LVDS Differential data input Channel 1(-)	30	VCC	Power supply (+5.0V)

6 Key Parts Pin Assignments

6.1 Panel general specifications

6.1.1 General Specifications

a. M220EW01 V0 (AUO)

Supplier	AUO
Model name	M220EW01 V0
Display Area	473.76(H) X 296.1(V)
Pixel Pitch	0.282(H) X 0.282(V)
Display Colors	16.7M
Number of Pixel	1680xR.G.B.x1050
Brightness	250cd/m2 (Min.), 300cd/m2 (Typical)
Contrast Ratio	Min: 800:1, Typical: 1000:1
Viewing Angle	Hor: 170°, Ver: 160° (Typical, CR>10)
Display Mode	Normally White
Frame rate	60Hz
Response Time	5 ms(Typical), 8ms (Max.)
Surface Treatment	Hard coating (3H),Non Glare
Lamp	4 CCFL
Outline Dimensions	493.7(W) X 320.1(H)x16.5 (D)
Brightness uniformity	80% (typ) / 75 % (min)

b. MT220W W01 V.0(INL)

Supplier	INL
Model name	MT220W W01 V.0
Display Area	473.76(H) X 296.1(V)
Pixel Pitch	0.282(H) X 0.282(V)
Display Colors	16.7M
Number of Pixel	1680xR.G.B.x1050
Brightness	250cd/m2 (Min.), 300cd/m2 (Typical)
Contrast Ratio	Min: 600:1, Typical: 1000:1
Viewing Angle	Hor: 160°, Ver: 160° (Typical, CR>10)
Display Mode	Normally White
Frame rate	60Hz
Response Time	5 ms (Typical), 10ms (Max.)
Surface Treatment	Hard coating (3H),AG(Haze 25%)
Lamp	4 CCFL
Outline Dimensions	493.7(W) X 320.1(H)x16.5 (D)
Brightness uniformity	80% (typ) / 75 % (min)

c. CLAA220WA01 (CPT)

Supplier	CPT
Model name	CLAA220WA01
Display Area	464.94(H) X 290.5875(V)
Pixel Pitch	0.27675 (H) X 0.27675(V)
Display Colors	16.7M(6bit+Hi-FRC)
Number of Pixel	1680xR.G.B.x1050
Brightness	250cd/m ² (Min.), 300cd/m ² (Typical)
Contrast Ratio	Min: 700:1, Typical: 1000:1
Viewing Angle	Hor: 170°, Ver: 160° (Typical, CR>10)
Display Mode	Normally White
Frame rate	60Hz
Response Time	5 ms (Typical), 8ms (Max.)
Surface Treatment	Hard coating(3H),AG(Haze 25%)
Lamp	4 CCFL
Outline Dimension	493.7(W) X 320.1(H)x16.5
Brightness uniformity	75 % (min)

6.2 Optical characteristic of LCD panel

6.2.1 AUO(M220EW01 V0):

Item	Unit	Conditions	Min.	Typ.	Max.	Remark
Viewing Angle	[degree]	Horizontal CR >= 10	160	170	-	
	[degree]	Vertical CR >= 10	150	160	-	
Contrast ratio		Normal Direction	800	1000		
Response Time	[msec]	Rising Time		3.6	5.5	
	[msec]	Falling Time	-	1.4	2.3	
	[msec]	Rising + Falling	-	5	8	
Color / Chromaticity Coordinates (CIE)		Red x	-0.03	0.646	+0.03	
		Red y		0.339		
		Green x		0.290		
		Green y		0.603		
		Blue x	-0.03	0.145	+0.03	
		Blue y		0.065		
Color Coordinates (CIE) White		White x		0.313		
		White y		0.329		
Luminance Uniformity	[%]	9 points measurement	75	80	-	
White Luminance at CCFL 7.0mA(center point)	[cd/m ²]		250	300	-	

- The test methods for the above items' definition please refer to the specification of M220EW01 V0 (AUO).

6.2.2 InnoLux Panel (MT220W W01 V.0):

Item	Unit	Conditions	Min.	Typ.	Max.	Remark
Viewing Angle	[degree]	Horizontal CR >= 10	140	160	-	
	[degree]	Vertical CR >= 10	140	160	-	
Contrast ratio		Normal Direction	600	1000		
Response Time	[msec]	Rising Time		1.5	3	
	[msec]	Falling Time	-	3.5	7	
	[msec]	Rising + Falling	-	5	10	
Color / Chromaticity Coordinates (CIE)		Red x	-0.03	0.640	+0.03	
		Red y		0.349		
		Green x	-0.03	0.284	+0.03	
		Green y		0.617		
		Blue x	-0.03	0.142	+0.03	
		Blue y		0.067		
Color Coordinates (CIE) White		White x		0.313		
		White y		0.329		
Luminance Uniformity	[%]	9 points measurement	75	80	-	
White Luminance at CCFL 7.0mA(center point)	[cd/m ²]		250	300	-	

- The test methods for the above items' definition, please refer to the specification of InnoLux Panel (MT220W W01 V.0)

6.2.3 CPT Panel (CLAA220WA01):

Item	Unit	Conditions	Min.	Typ.	Max.	Remark
Viewing Angle	[degree]	Horizontal CR >= 10	150	170	-	
	[degree]	Vertical CR >= 10	140	160	-	
Contrast ratio		Normal Direction	700	1000		
Response Time	[msec]	Rising Time		--	--	
	[msec]	Falling Time	-	--	--	
	[msec]	Rising + Falling	-	5	8	
Color / Chromaticity Coordinates (CIE)		Red x	-0.03	0.651	+0.03	
		Red y		0.330		
		Green x	-0.03	0.267	+0.03	
		Green y		0.630		
		Blue x	-0.03	0.145	+0.03	
		Blue y		0.080		
Color Coordinates (CIE) White		White x		0.313		
		White y		0.329		
Luminance Uniformity	[%]	9 points measurement	75		-	
White Luminance at CCFL 7.0mA(center point)	[cd/m ²]		250	300	-	

- The test methods for the above items' definition, please refer to the specification of CPT (CLAA220WA01)

6.3 U701 (Audio amplifier)TDA7496L

SYMBOL	PIN	DESCRIPTION
GND	1	Ground
GND	2	Ground
GND	3	Ground
Signal L	4	Signal input left
VAR out	5	VAR output
VOLUME	6	DC volume control
VAR out	7	VAR output
NC	8	Not connected
Signal R	9	Signal input right
SVR	10	Supply voltage rejection
STBY	11	Standby
MUTE	12	Sound mute
GND	13	Ground
OUTR	14	Audio output right
VS	15	Power supply
VS	16	Power supply
OUTL	17	Audio output left
GND	18	Ground
GND	19	Ground
GND	20	Ground

6.4 IC501 (OZ9910G, CCFL Inverter controller IC)

Pin	Symbol	I/O	Description
1	NDRV2	O	Bottom MOSFET gate drive output in dual forward converter
2	PGND		High-current power ground
3	NDRV1	O	Bottom MOSFET gate drive output in dual forward converter
4	GNDA		Low-current signal ground
5	CT	I	Timing capacitor of high frequency oscillator
6	LCT	I	Timing capacitor to set LPWM frequency
7	DIM	I	Control command input -- DC
8	ENA	I	Enable input
9	VSEN	I	Voltage sense feedback
10	CMP_SST	I	Soft start and loop compensation capacitor
11	ISEN	I	Current sense feedback
12	V5000	O	Reference voltage output
13	VIN	I	Supply voltage for IC
14	HSB	I	High side driver buffer output
15	PDRV1	O	Top MOSFET gate drive output in dual forward converter
16	PDRV2	O	Top MOSFET gate drive output in dual forward converter

6.5 IC802 (NCP1203)

Pin No.	Pin name	Function	Pin Description
1	Adj	Adjust the skipping peak current	This pin lets you adjust the level at which the cycle skipping process takes place. Shorting this pin to ground, permanently disables the skip cycle feature.
2	FB	Sets the peak current setpoint	By connecting an optocoupler to this pin, the peak current setpoint is adjusted accordingly to the output power demand. Skip cycle occurs when FB falls below V_{pin1} .
3	CS	current sense input	This pin senses the primary current and routes it to the internal comparator via and L.E.B.
4	Gnd	The IC ground	
5	Drv	Driving pulses	The driver's output to an external MOSFET.
6	Vcc	Supplies the IC	This pin is connected to an External bulk capacitor
7	Nc		This unconnected pin ensures adequate creepage distance.
8	HV	Ensure a clean and lossless start-up sequence	Connected to the high-voltage rail, this pin injects a constant current into the Vcc capacitor during the start-up sequence

5. Adjustment Procedure

1.1 Control buttons on the Back bezel

- 3 buttons at the rear side of monitor
 - “UP”
 - Activate the Volume control menu, and increase the value (optional)
 - View the previous function in the main OSD menu
 - Increase the value of specific function which has been selected
 - “MENU/POWER”
 - Turn on the monitor
 - Activate the OSD control menu
 - Select the specific function
 - Turn off the monitor by pressing the button for 3 seconds
 - “DOWN”
 - Activate the Volume control menu, and decrease the value (optional)
 - View the next function in the main OSD menu
 - Decrease the value of the specific function which has been selected
 - “UP” and “DOWN”
 - Activate the Auto Adjustment function to optimize the picture performance automatically

1.2 Hot Key Operation

FUNCTION	DESCRIPTION				
	MENU ①	⊖	⊕	Power status	
Factory Mode	•	•		OFF	Enter Factory Mode
Auto		•	•	ON	Activate Auto Adjustment function

2.OSD Control

The on-screen display (OSD) shall be an easy to use icon based menu through keypad OSD buttons or remote control unit. The unit shall leave the factory with all OSD controls set to their default values.

• Main Menu

Level 1	Level 2	Level 3	Default	
EXIT				
AUTO ADJUSTMENT				
CONTRAST			70%	
BRIGHTNESS			100%	
OSD MENU LANGUAGE	EXIT		ENGLISH	
	ENGLISH			
	KOREAN			
	GERMAN			
	FRENCH			
	ITALIAN			
	SPANISH			
	JAPANESE			
	SIMPLIFIED CHINESE			
	TRADITIONAL CHINESE			
POWER SAVING MODE	EXIT		STANDARD	
	STANDARD			
	ADVANCED			
OTHERS	EXIT			
	AUTO COLOR			
	COLOR TEMPERATURE	EXIT		USER
		USER/RED		100%
		USER/GREEN		100%
		USER/BLUE		100%
		sRGB		6500K
		9300K		
		6500K		
	OSD MENU POSITION	EXIT		CENTER
		RIGHT		
		CENTER		
		LEFT		
	PHASE			By Timing
	HORIZONTAL POSITION			50%
VERTICAL POSITION			50%	
INFORMATION			BY TIMING	
RECALL				

3. Factory Mode Introduction

When signal is input, press “power key” to turn off the monitor. Press “-” and “Power” together to turn on the monitor. After power on, press “Power” to call out Main Menu, then press “-“for select the “F” item, then press “power/menu”, you can go into Factory mode.

EXIT:	Escape from Factory menu.
PANEL:	Display panel information.
AUTO COLOR:	Automatically calibrate chip ADC parameter by using chip internal DAC.
GAIN:	ADC gain value
OFFSET:	ADC offset value
SPAN and STEP:	Spread spectrum value.
BRI:	Brightness value
CON:	Contrast value
9300K:	Set color temperature 9300K
6500K:	Set color temperature 6500K
USER:	Set user preferred color temperature
RS232:	F/W RS232 debug on or off
BANK, ADDR, VALUE, HTOTAL:	F/W adjust the scaler register and htotal to panel for better performance.
TIME:	The time of backlight used.

4. Burn-in pattern

Enter the factory mode, Plug out VGA, Burn-in pattern will self generate automatically. You can not escape from Burn-in pattern until plug in VGA Cable or press the Menu/Power key,.

5. Auto Color Balance (Automatically calibrate chip ADC parameter by using chip internal DAC.)

If it is a new-built set and it is first time to do the “auto color”, please confirm the following steps:

- Connect the VGA cable with the standard video pattern generator and display 32-gray pattern on the monitor.
- Press “Power” to power off the monitor.
- Enter the Factory Mode.
- Then press the “Menu/POWER” to execute Auto Color item.
- After the “Auto Color” process finished, please press “Power” to restart monitor.

6. EDID (Rewrite EDID data to EEPROM)

If we need to rewrite the EEPROM data, please confirm the following steps.

1. Plug in VGA Cable; we can rewrite the EDID data to EEPROM by using “EDID Rewrite” program.
2. If the “EDID Rewrite” process finished, please pull out AC power cable or press power key to restart

7. Upload firmware to MCU via VGA Cable

7.1 Connect ISP board between monitor and PC as below configuration.

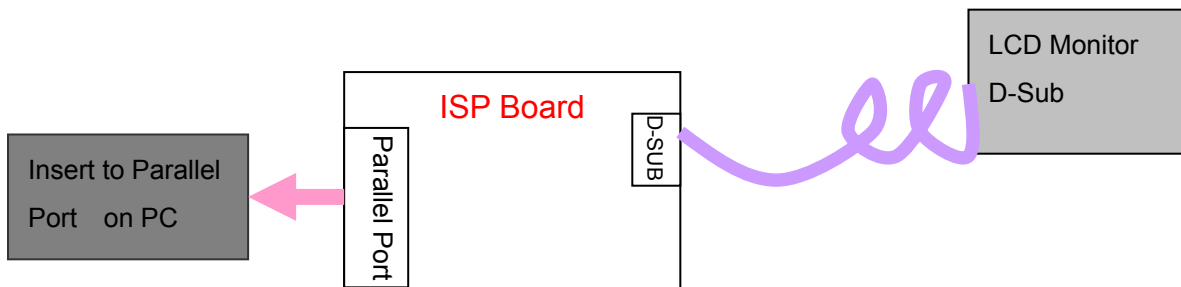

7.2. Press the “connect” button in ISP.exe, and select the device type, which is used in this monitor. Choose the corresponding firmware version, and load to MCU.

7.3. After finish, please plug out power cable and re-start monitor again.

8. after repair, to ensure the quality you should do the following test and adjustment

Item	Content	Equipment	
Test OSD function	<ol style="list-style-type: none"> Signal is set as 1440×900@60Hz under General-1 Checking whether each single function key and compound function key can be worked. 	Chroma Signal Generator	
Contrast Check	<ol style="list-style-type: none"> Set input mode to 1440×900@60Hz Set Pattern to 32 gray shades Set contrast to the max. The brightest 5~8 shades brightness cannot be distinguished. 	Chroma Signal Generator	
Color Temperature	<ol style="list-style-type: none"> Do “Auto color Balance” at 1440×900@60Hz, 32gray shades Measure color temperature, check it complies with the following temperature : $6500K \ x = 0.313 \ +/- \ 0.03, \ y = 0.329 \ +/- \ 0.03$ $9300K \ x = 0.283 \ +/- \ 0.03, \ y = 0.298 \ +/- \ 0.03$ 	Chroma Signal Generator and color analyzer	
Modes switching check	<ol style="list-style-type: none"> Use Chroma Pattern Generator to make sequence. VESA (640x480 800x600 1024x768 1280x1024), and power saving signal,etc. Confirm the above timing modes must be full screen and the picture must be normal. LED is amber at power saving mode. 	Chroma Signal Generator	
VGA cable detector	When VGA cable is not plugged, the monitor will work in power saving mode.	Visual check Chroma Signal Generator	
Panel Flicker check	<ol style="list-style-type: none"> Mode:1440×900@60Hz Set Brightness& contrast to default value Do “Auto Adjustment” Shut down PC to check whether there’s glitter on the center of the picture. 	Chroma signal generator & PC	
Power saving	<ol style="list-style-type: none"> Mode:1440×900@60Hz Pattern: full white Brightness: Max. Contrast: Default Check power consumption 	at each modes	
	State	Power Consumption	LED color
	Normal		green
	Stand By		amber
	Power Key Off		no

Disassembly Procedure



BASE



HINGE COVER



STAND





Front Cover



Back Cover



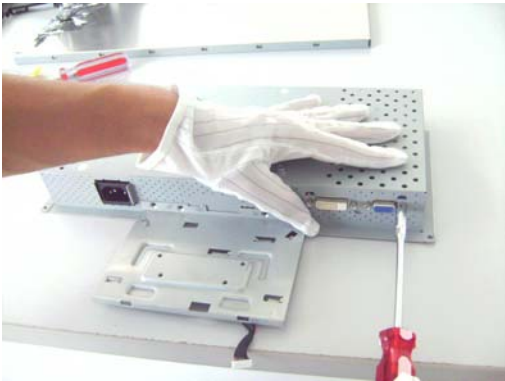

Keypad Board

Chassis



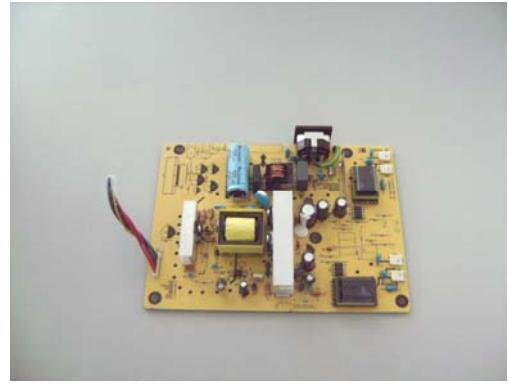
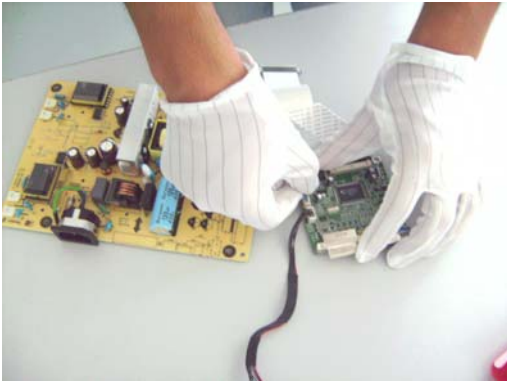

Power Board

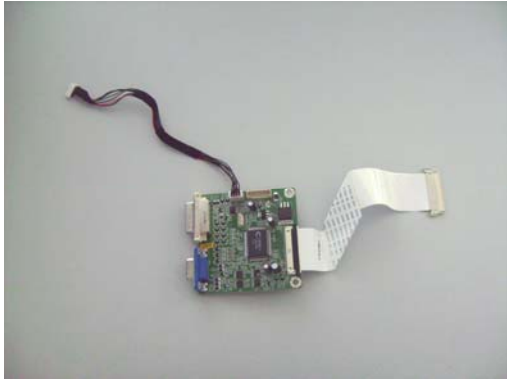

Key Power Cable

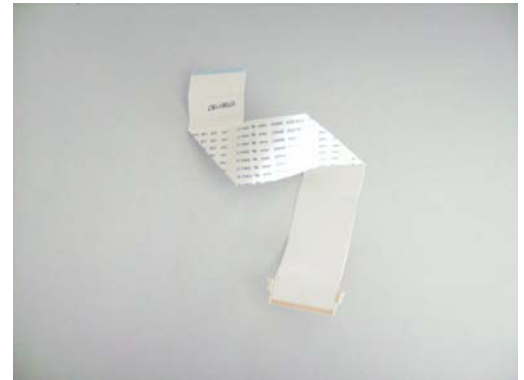
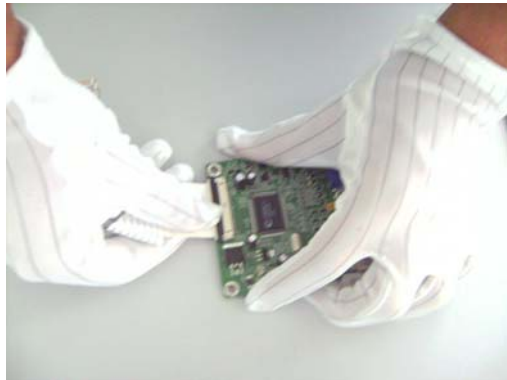

LVDS Cable





I/F Board

Packing Procedure

1.1 Paste protection film to protect the monitor. (Figure 1)

1.2 Put the monitor in the PE bag and seal the bag with tape. (Figure 2)



Figure 1

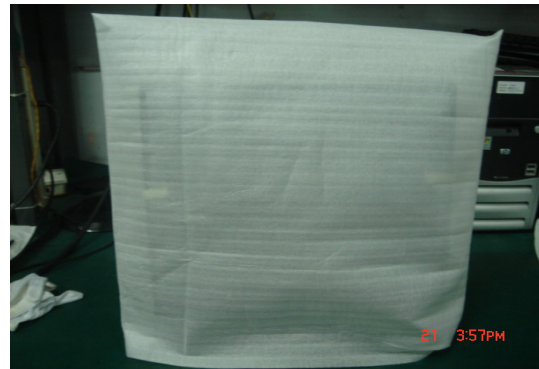

Figure 2

1.3 Put the cushions on the monitor.

1.4 Place the monitor into the carton and then put all the accessories into the carton. At last, close the carton and seal it with tape.(Figure3)

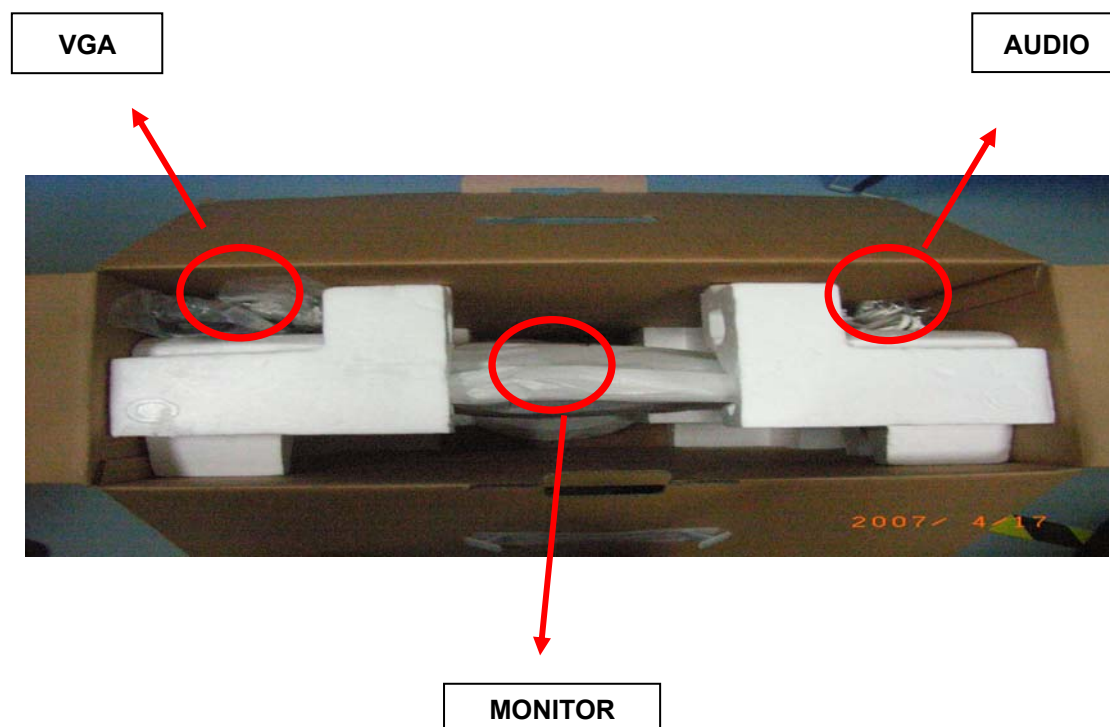

Figure 3

6. Troubleshooting Flow Chart

6.1. Common Acknowledge

- If you change the interface board, be sure that the U103, U105, U106 and U108 these three components also changed to the new I/F board because there was program inside. If not, please re-write EDID and upload firmware into U106 via VGA Cable.
- If you adjust clock and phase, please do it at the condition of Windows shut down pattern.
- If you confirm the R.G.B. color is normal or not, please do it under 16-grey scalar pattern.
- This LCM is analog interface. So if the entire screen is an abnormal color that means the problem happen in the analog circuit part, if only some scale appears abnormal color that stand the problem happen in the digital circuit part.
- If you check the H/V position, please use the crosshatch pattern.
- This LCM support more than 30 timing modes, if the input timing mode is out of specification, the picture may appears abnormally.
- If brightness uneven, repairs Inverter circuit or change a new panel.
- If you find the vertical line or horizontal line lost on the screen, please change panel.
- If you find the speaker don't working, please don't plug in audio cable, unless change new speaker.

6.2. No Power & Power LED Off

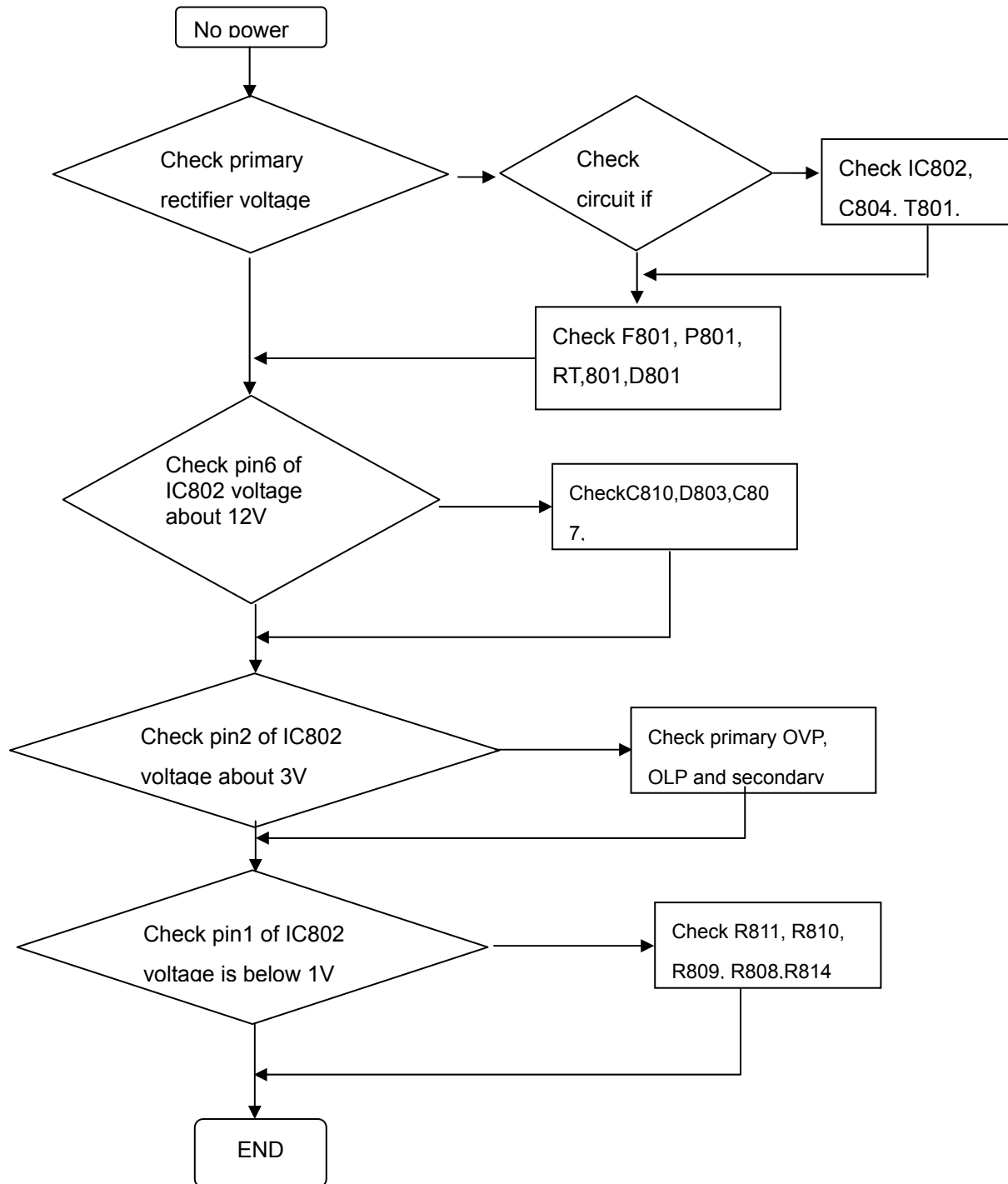

6.3. DC output voltage is unstable

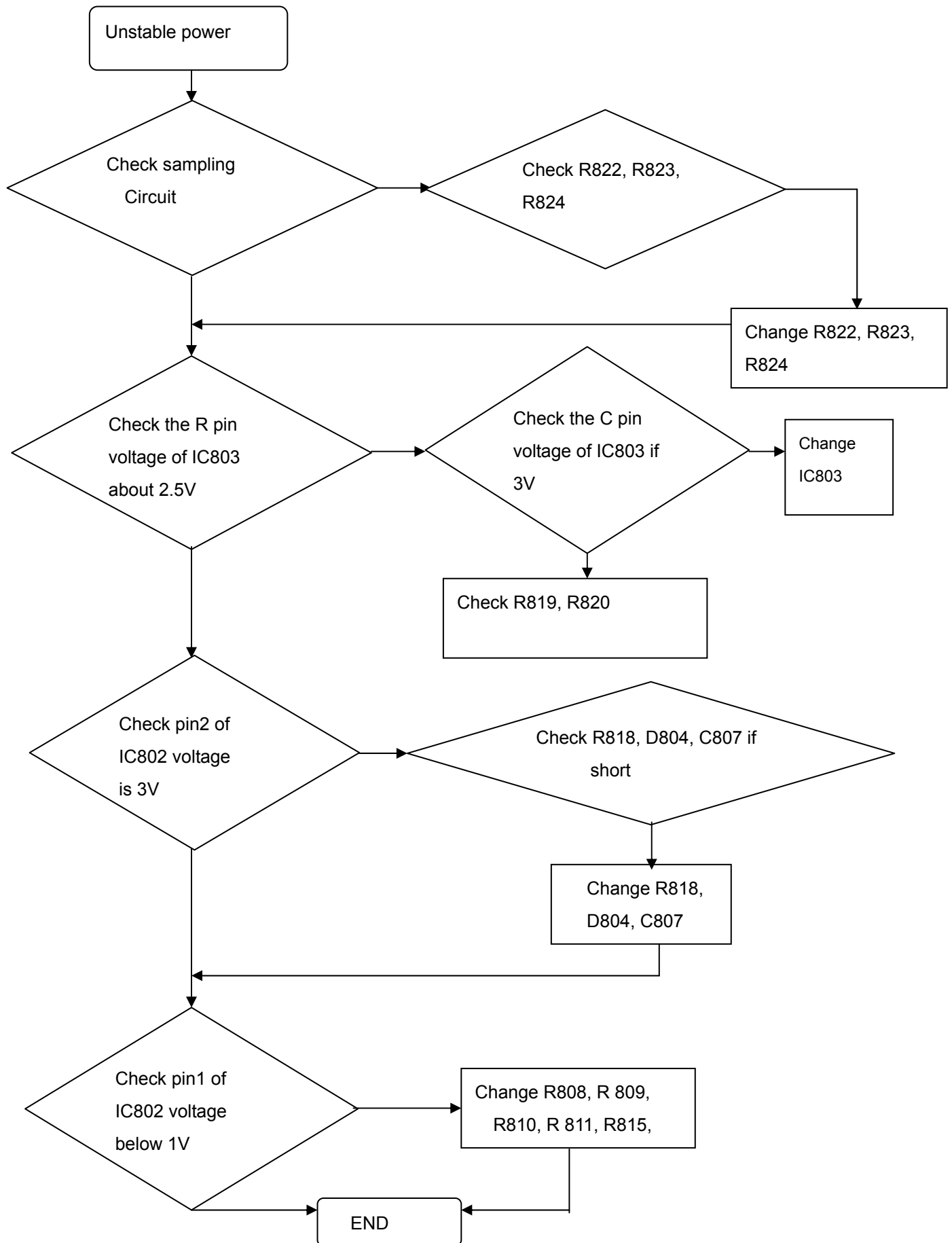

6.4. Output power is unstable

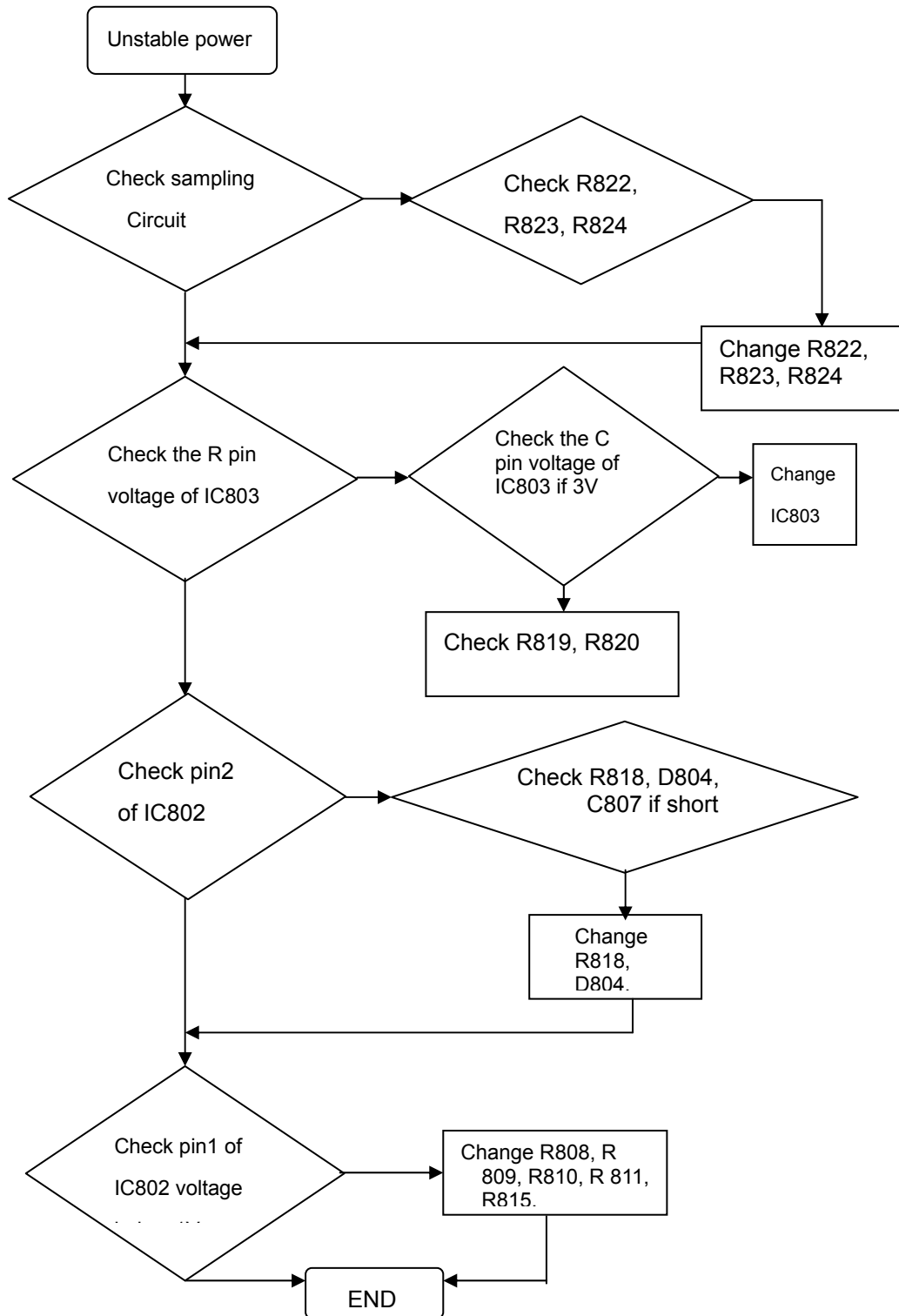

6.5. Backlight can't be turned on

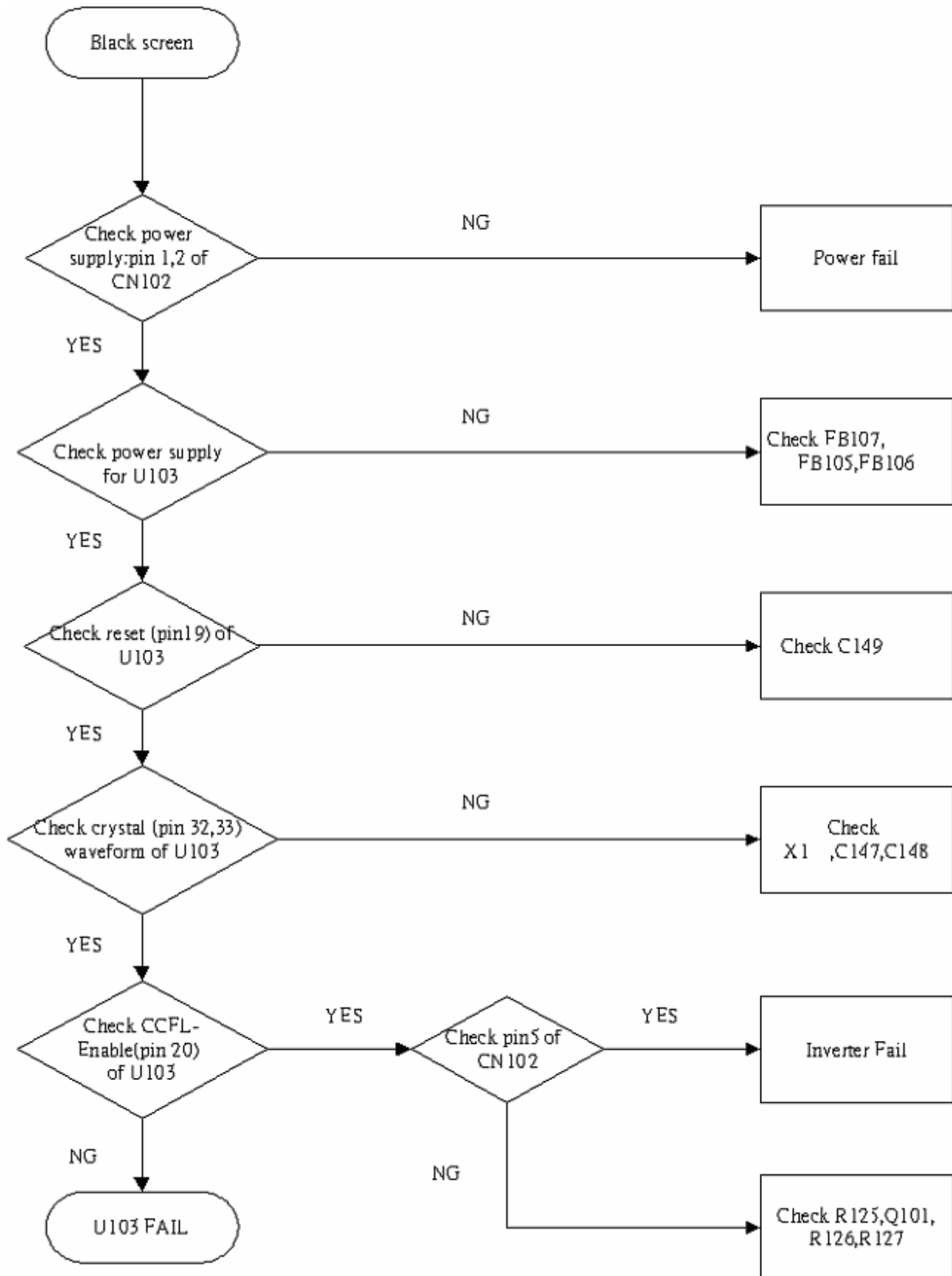

6.6 Black Screen and backlight turn on

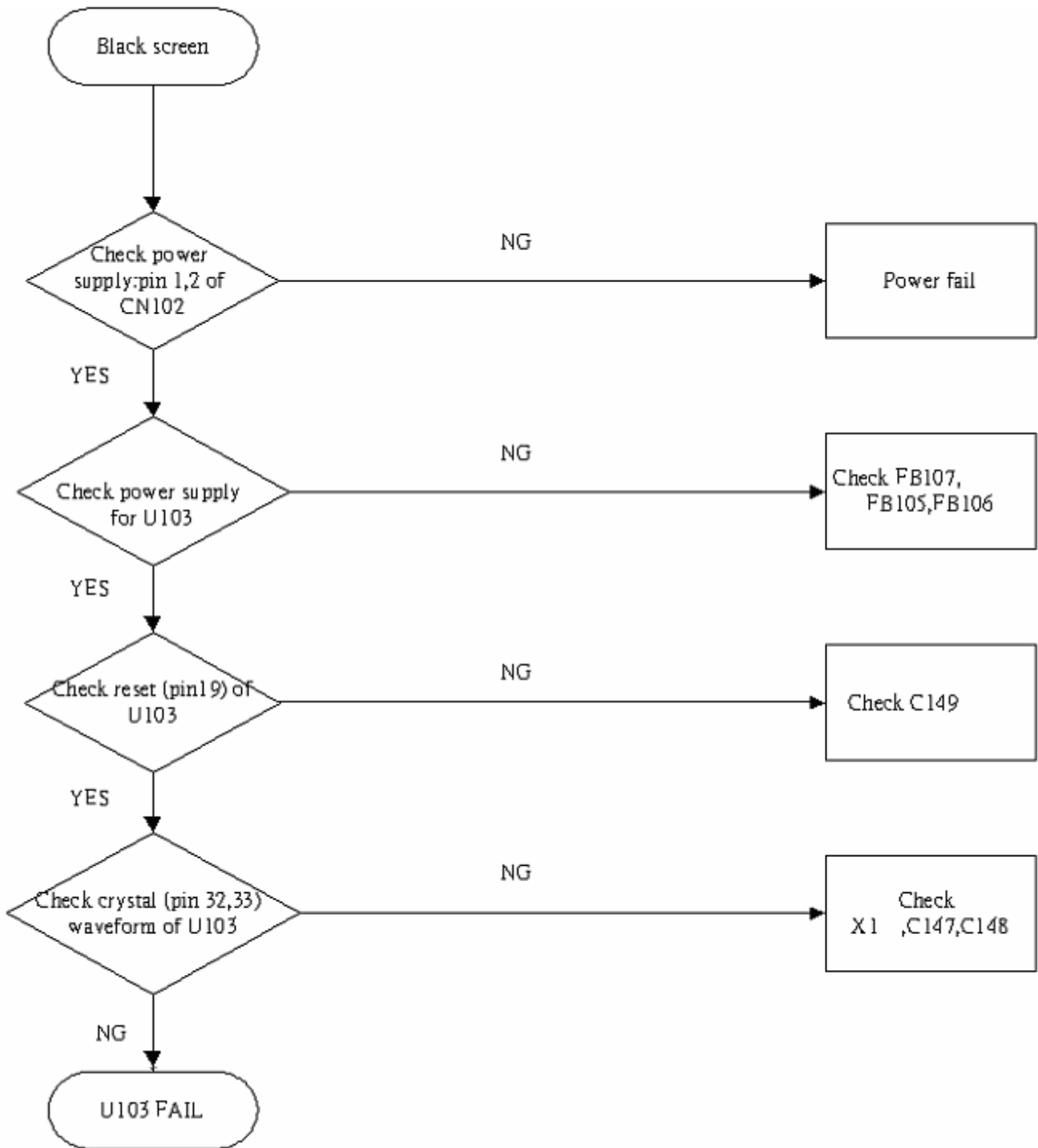

6.7 White Screen

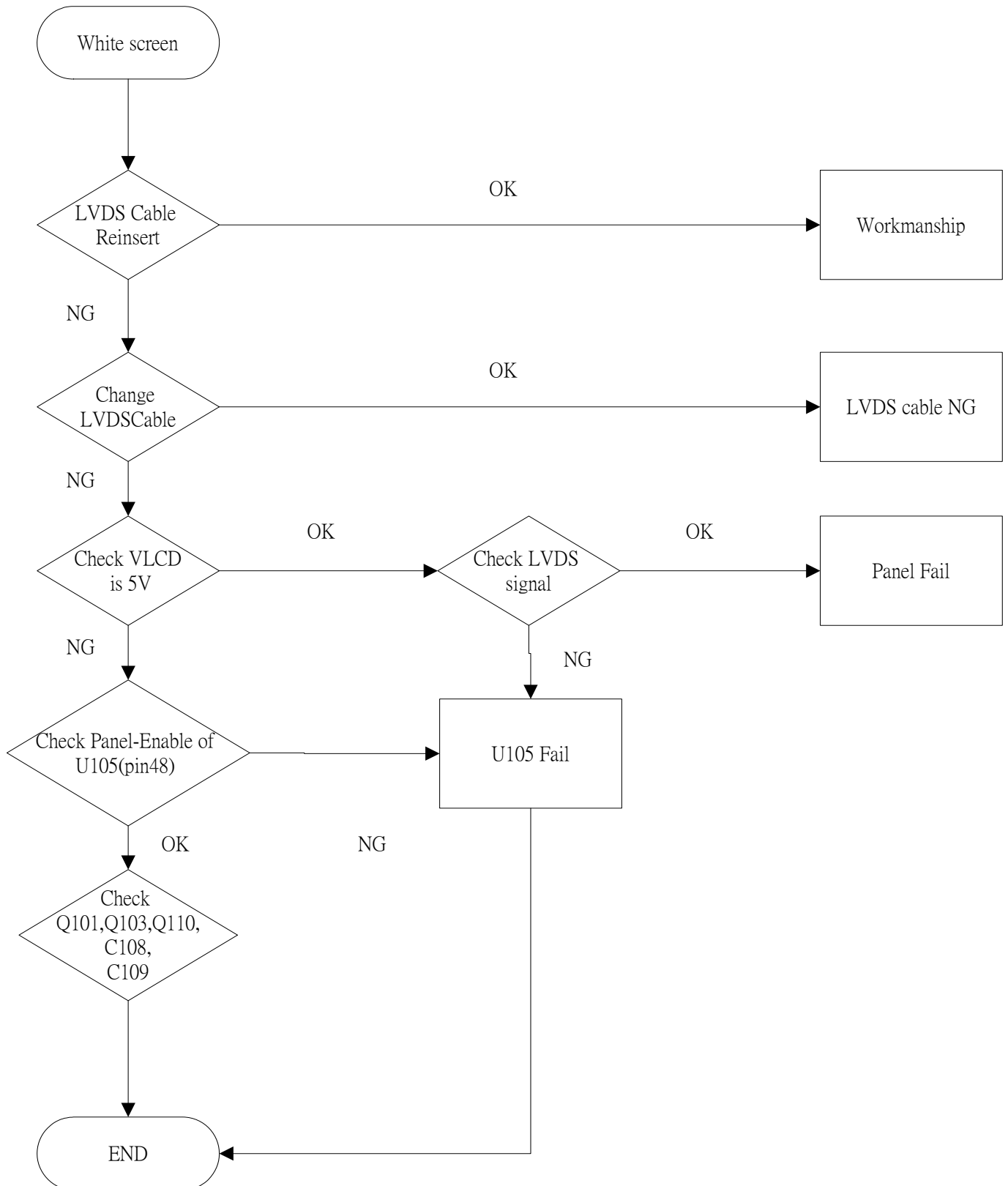

6.8 Bad Screen

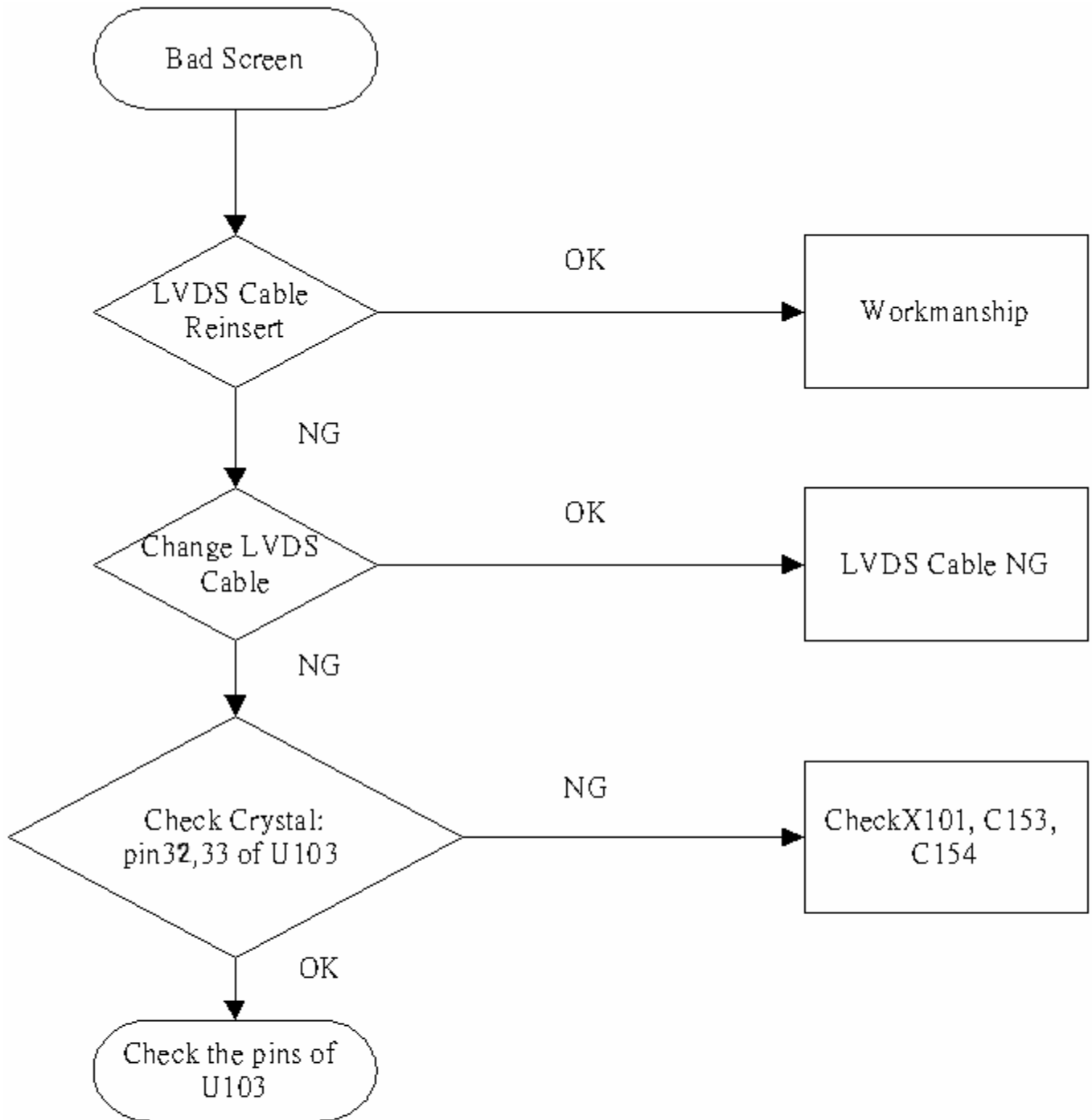

7. Block Diagram

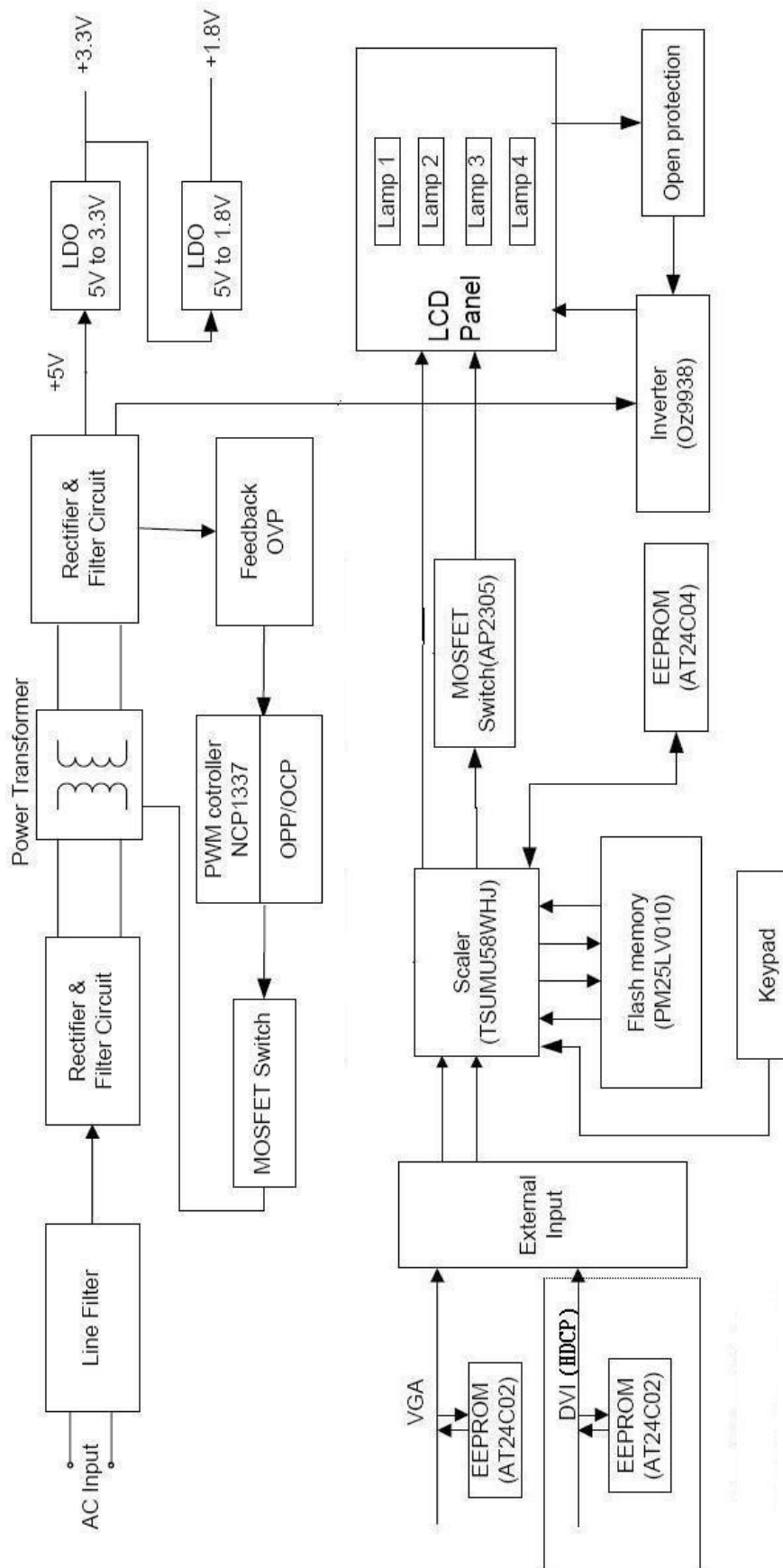

8. Schematic Diagrams

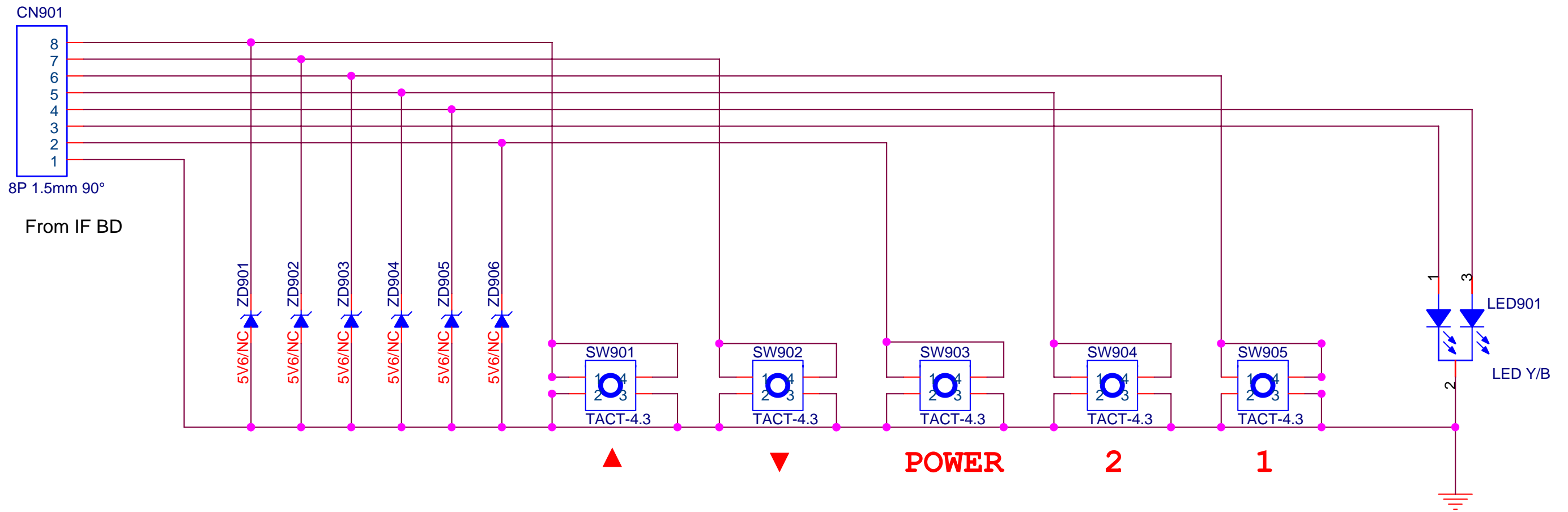

ViewSonic Corporation	
Model	
Title	Keypad & Power key
Date	Rev:

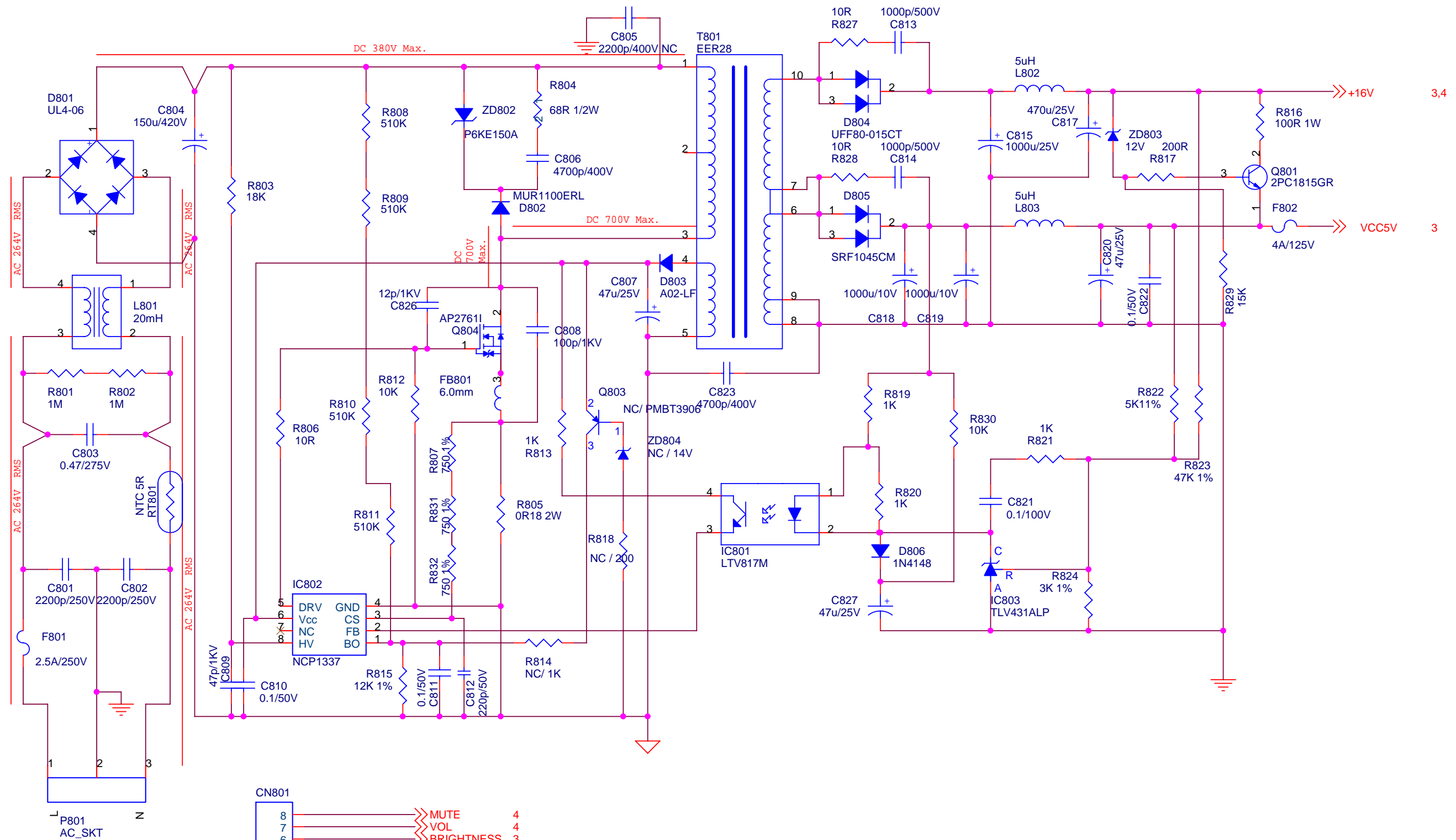

3,4
3

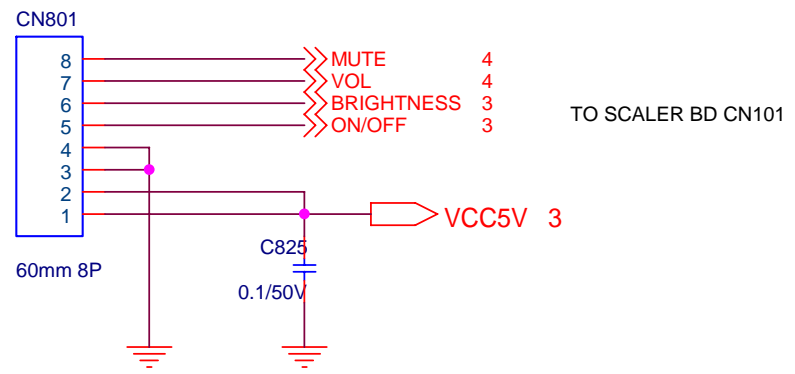

ViewSonic Corporation			
Model			
Title	Power Supply SCH		
Date			Rev:

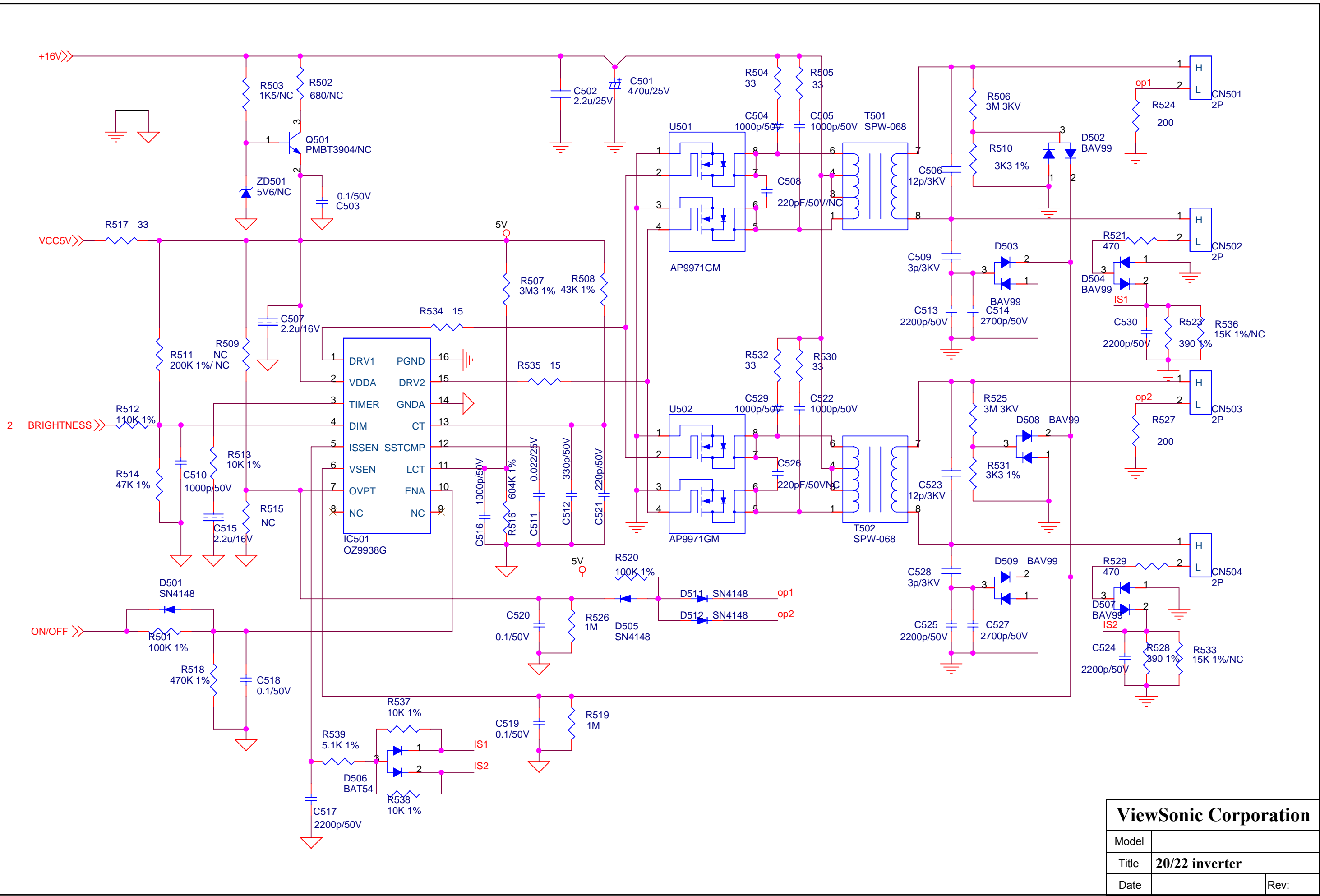

ViewSonic Corporation

Model	
Title	20/22 inverter
Date	
Rev:	

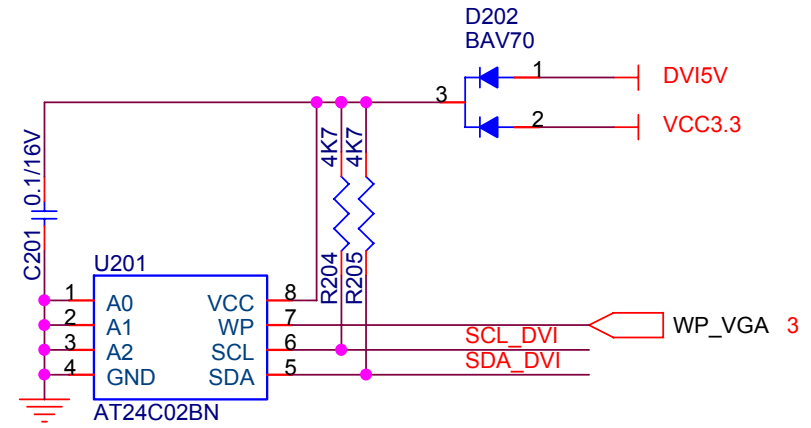
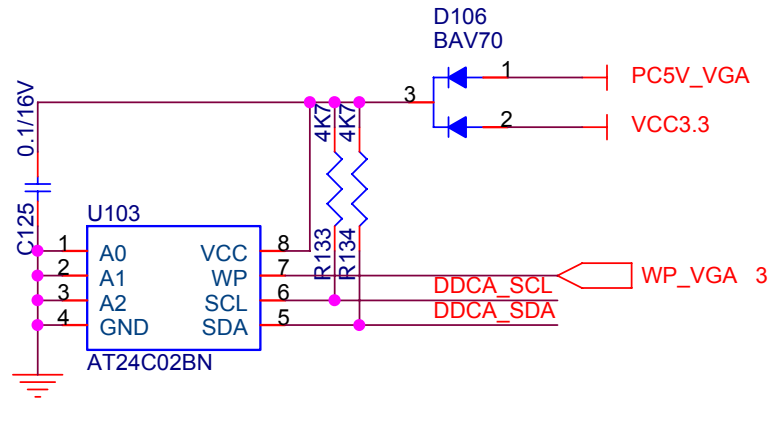
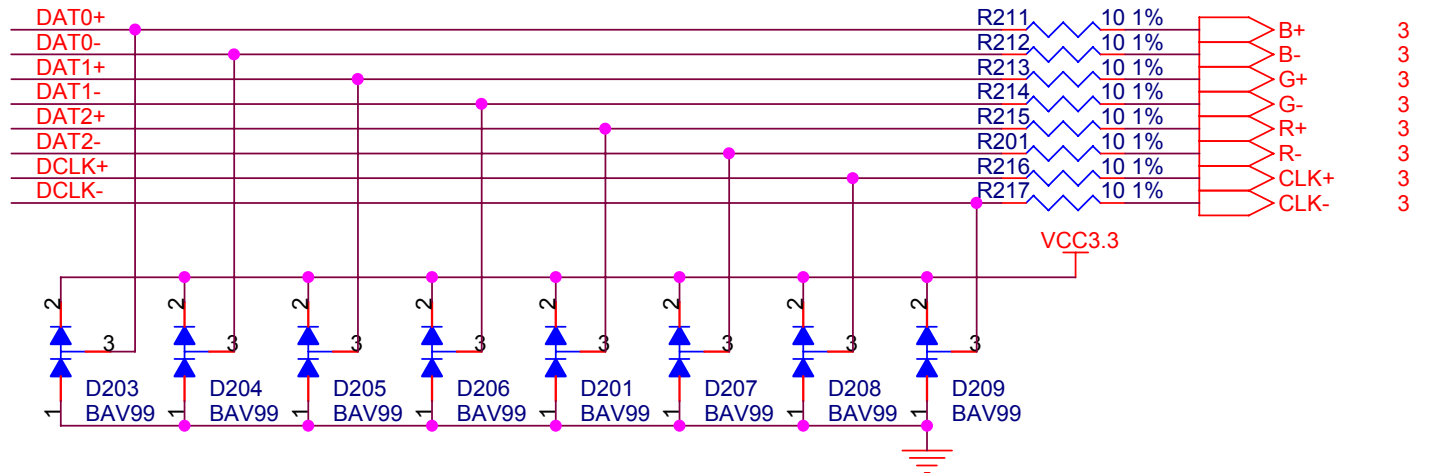
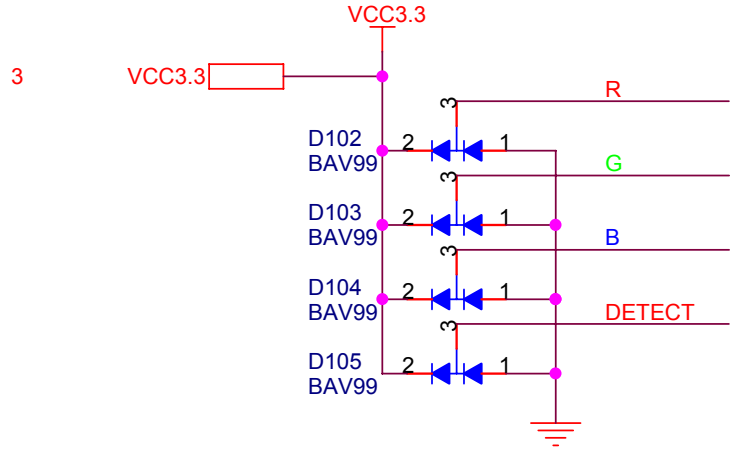
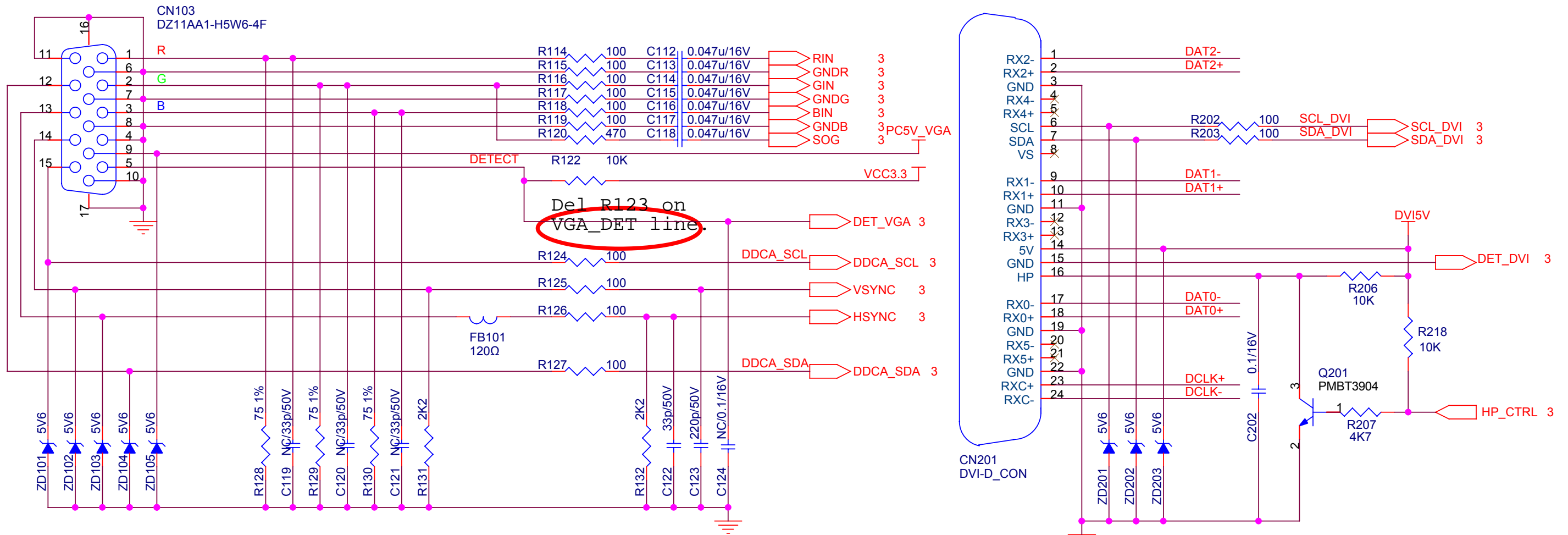

ViewSonic Corporation	
Model	
Title	Input
Date	Rev:

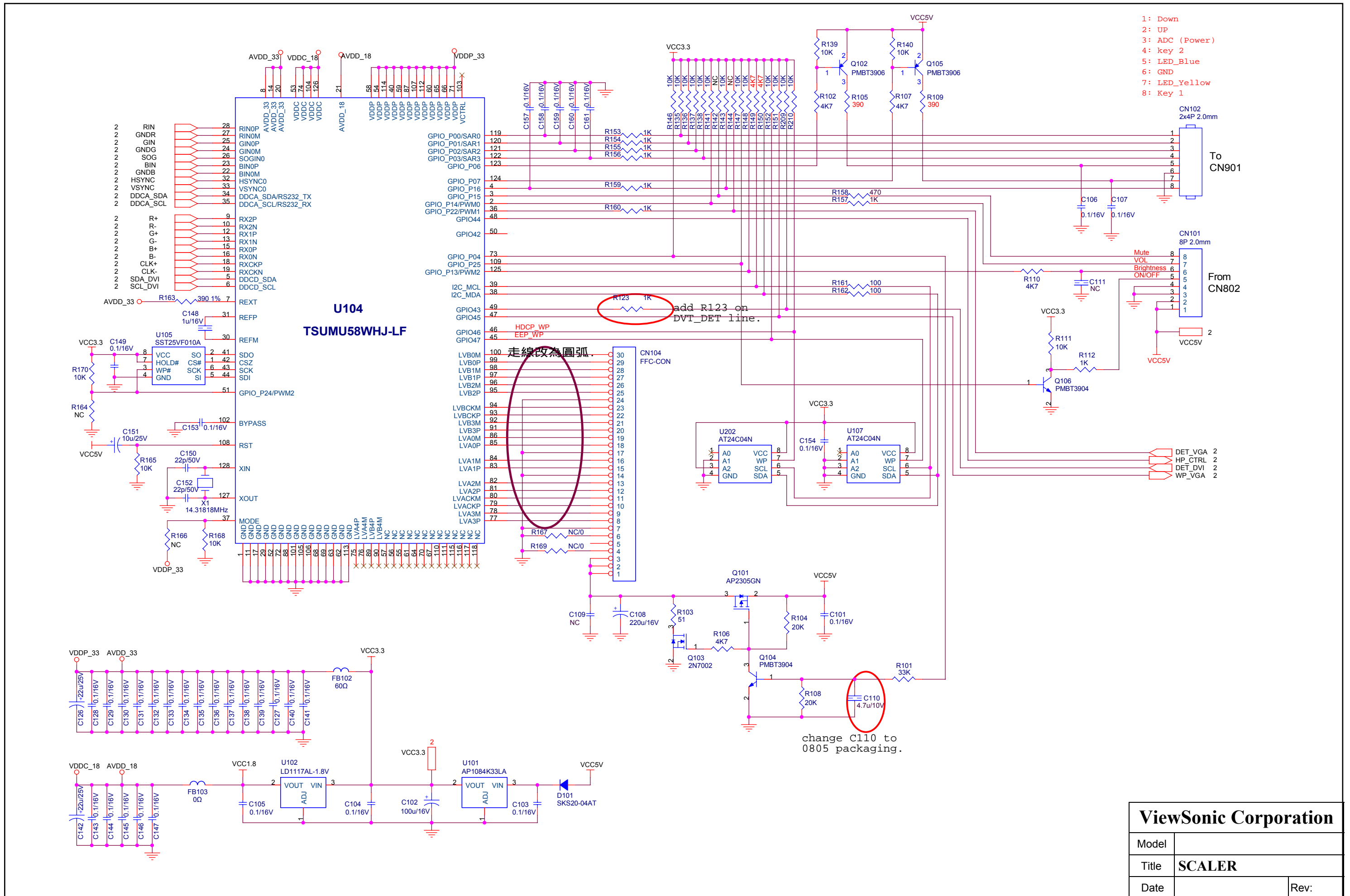

9. PCB Layout Diagrams

490741300200R

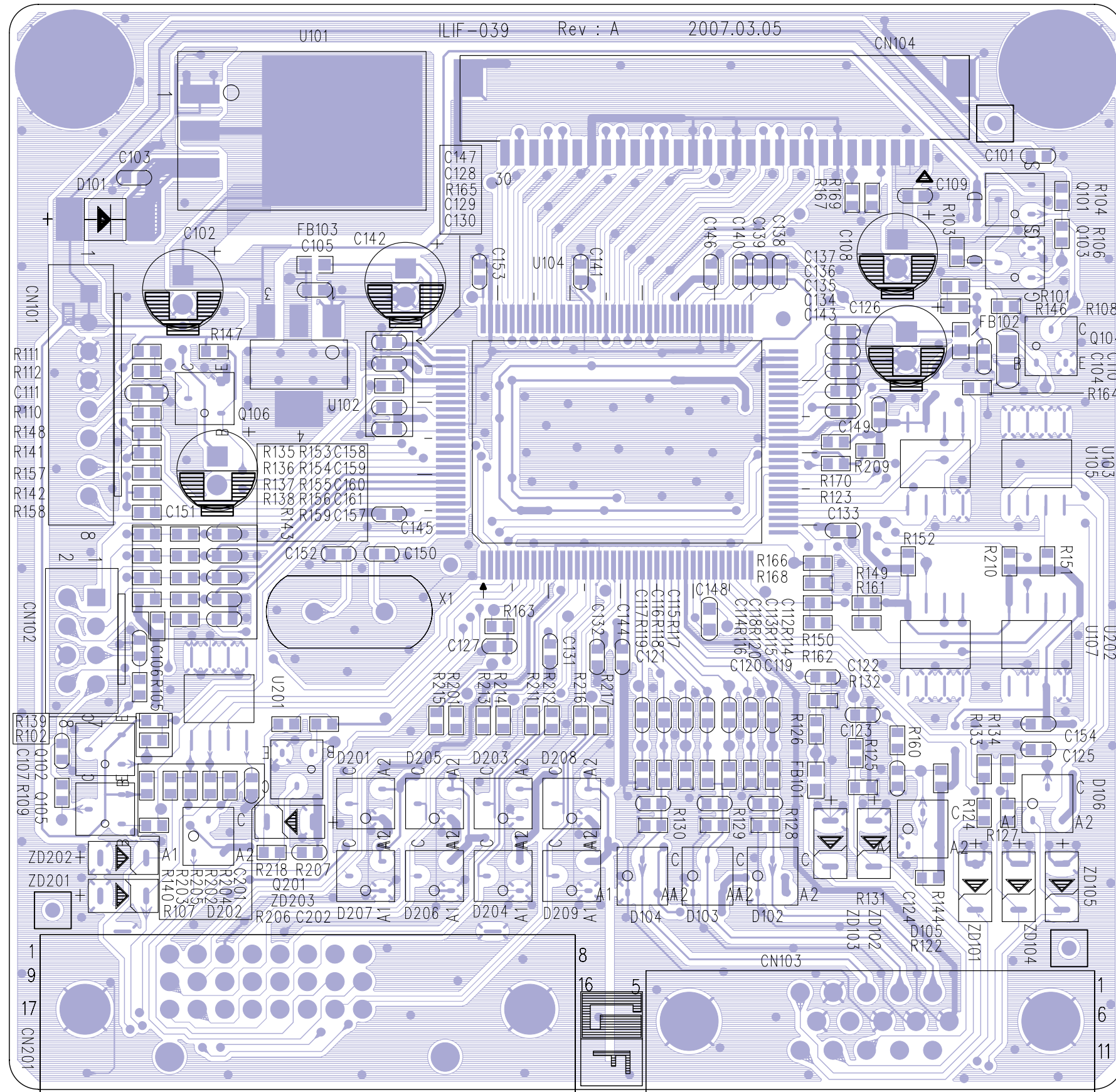

LAYER		SILKSCREEN TOP	
PCB NO :	ILIF-039	REV :	A
DESIGNER:	Eva	DATE :	2007.03.05
FILE NAME :	ILIF-039.PCB		

490741300200R

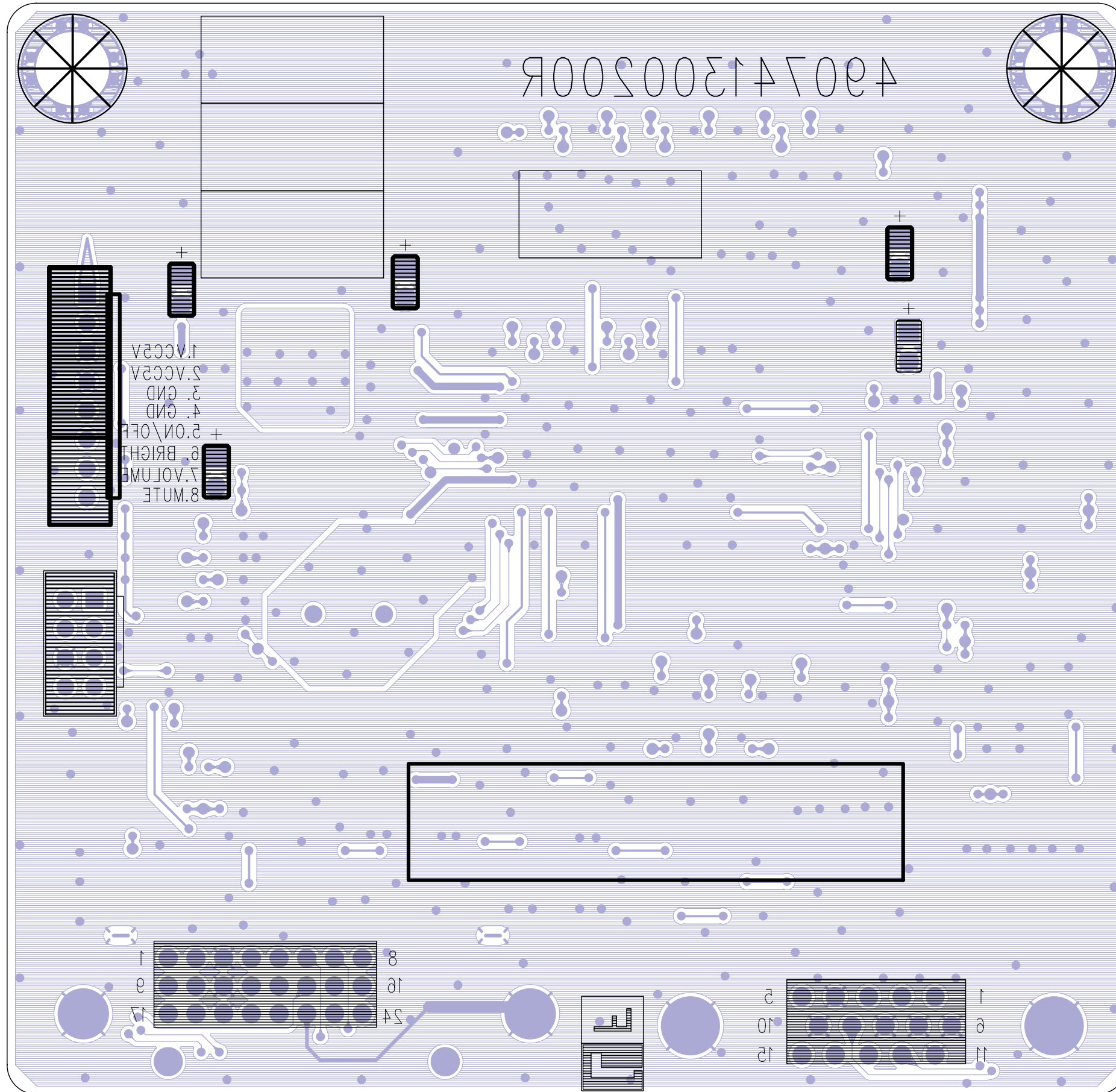

LAYER	SILKSCREEN BOTTOM		
PCB NO :	ILIF-039	REV :	A DESIGNER: Eva
FILE NAME :	ILIF-039.PCB	DATE :	2007.03.05

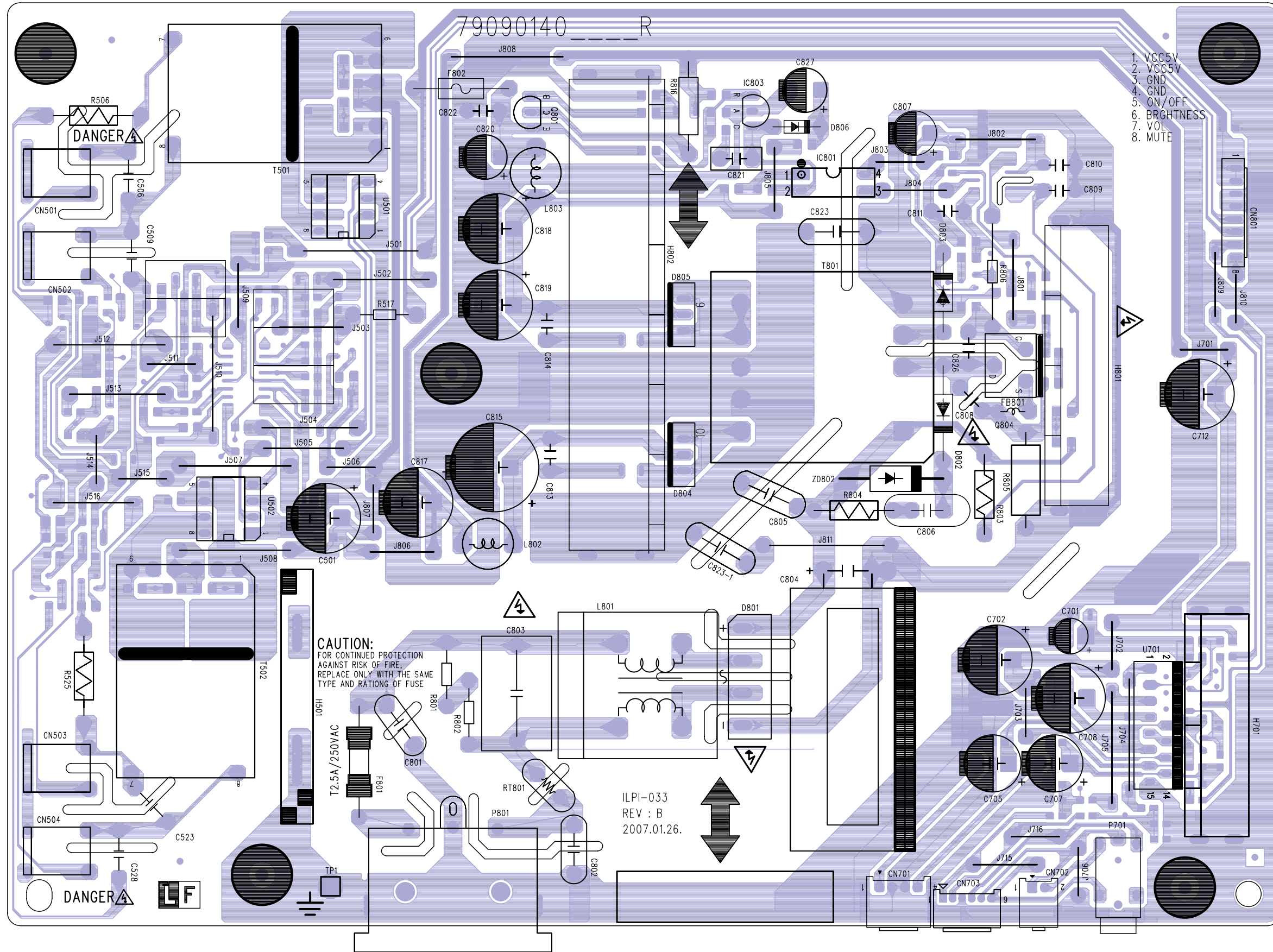

LAYER		SILKSCREEN TOP		
PCB NO :	ILPI-033	REV :	B	DESIGNER: LIU HUA
FILE NAME :	ILPI-033 .PCB	DATE :	2007.01.26.	

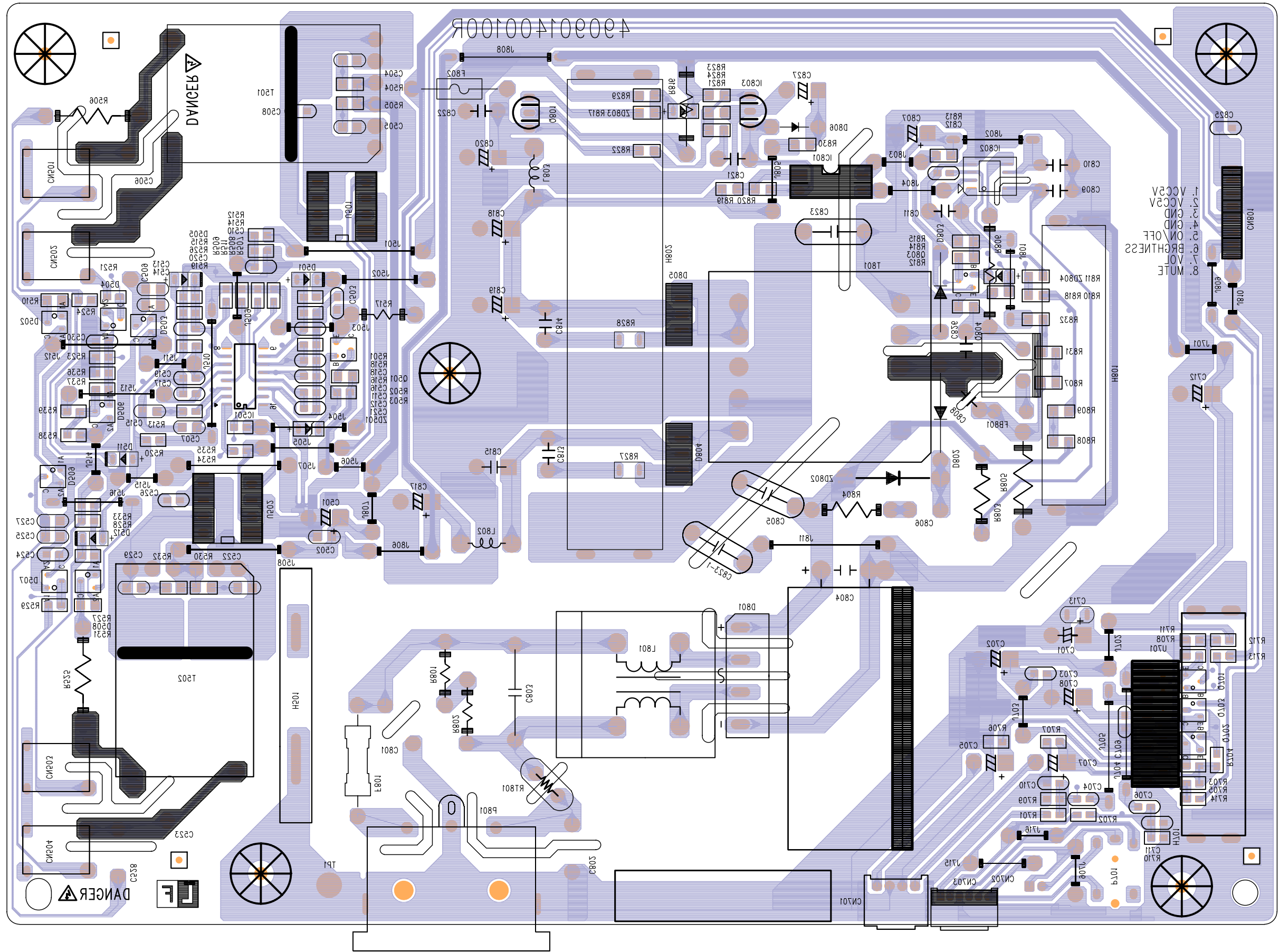

1. VCC3V
 2. VCC2V
 3. GND
 4. GND
 5. ON/OFF
 6. BRIGHTNESS
 7. VOL
 8. MUTE

LAYER				SILKSCREEN BOTTOM			
PCB NO :	ILPI-033	REV :	B	DESIGNER:	LIU HUA		
FILE NAME :	ILPI-033 .PCB	DATE :	2007.01.26.				

10. Exploded Diagram and Exploded Parts List

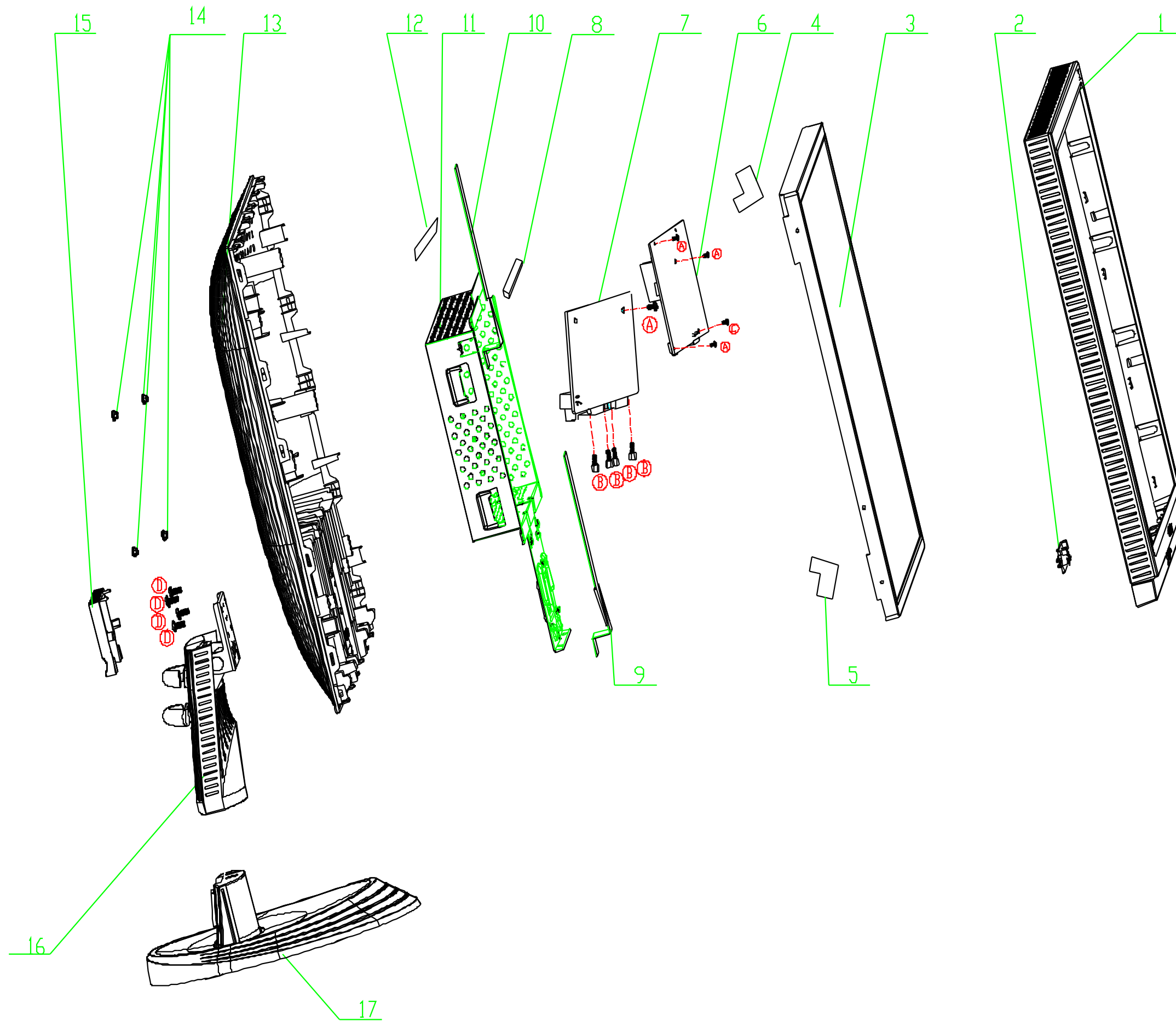

EXPLODED PARTS LIST (VA2226w-1)

ViewSonic Model Number: VS11803

Rev: 1a

Serial No. Prefix: QQK

Item	ViewSonic P/N	Ref. P/N	Description	Q'ty
1	C-00008577	714030011200R	ASSY,BEZEL,ASM,GENERAL,LE2275	1
2	B-00008567	791031500000R	KEYPAD	1
3	E-00008424	631102220091R	PANEL 22" W	1
4	N/A	511150102600R	FOIL,AL.,DOUBLE COND,LEFT,LE2239	1
5	N/A	511150102610R	FOIL,AL.,DOUBLE COND.,RIGHT,LE2239	1
6	B-00008566	791031400000R	POWER BOARD	1
7	B-00008574	791031300600R	IF BOARD	1
8	N/A	503060005800R	GASKET,EMI,180XW10XH6.5,LE2280	1
9	CB-00008353	430300801250R	KEYPAD CABEL	1
10	CB-00008192	430303000840R	LVDS CABLE	1
11	N/A	701000004800R	ASSY,CHASSIS,W/DVI, LE2275	1
12	N/A	511150101800R	FOIL,AL.,DOUBLE COND,60X35XT0.07mm,LE2016	1
13	N/A	714050010300R	ASSY,BACK,Asm,W/DVI,LE2275	1
14	N/A	503040000600R	RUBBER,COVER BLACK LE2082	4
15	C-00008570	501020216100R	HINGE,COVER,LE2082	1
16	PL-00008187	714010005100R	ASSY,STAND,LE2082 ROHS	1
17	C-00008567	714020002200R	ASSY,BASE, LE2082 ROHS	1
A	HW-00005269	509146305300R	SCREW,PW,CROSS,W/WAS,M3*5,NI	4
B	HW-00005270	509000000700R	BOLT,#4-40*11.8,NI	4
C	N/A	509146306102R	SCREW,P,CROSS W/W-SPR,M3*6,Zn,ROHS	1
D	N/A	509116608510R	SCREW,P,CROSS,M4*8,Black, NL(Nylok)	4

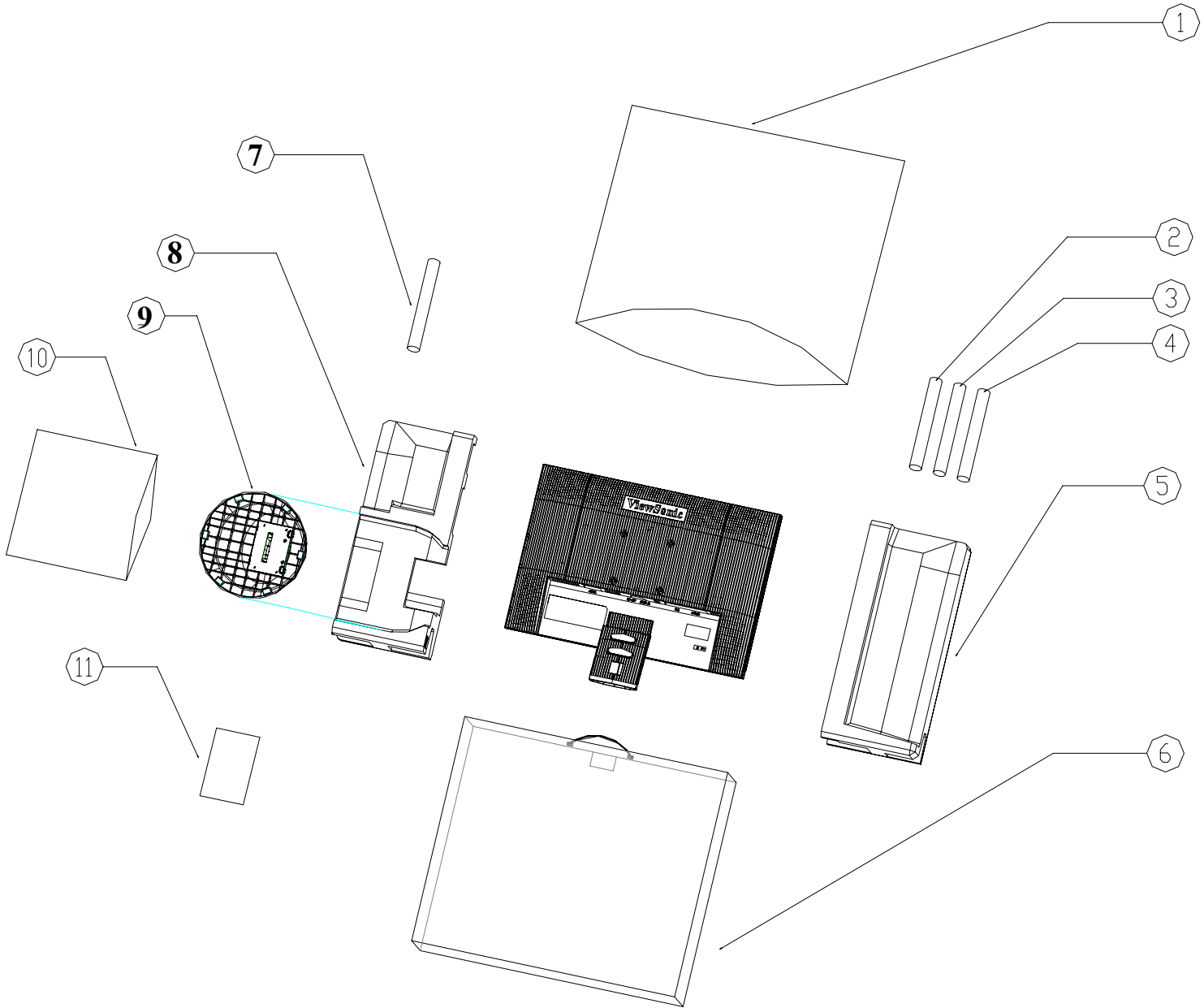

PACKING PART LIST (VA2226w-1)

ViewSonic Model Number: VS11803

Rev: 1a

Item	ViewSonic P/N	Ref. P/N	Location	Q'ty
1	P-00008419	506120300430R	BAG,PO+EPE,L590xW530xT0.6mm(PRINTED)LE2239	1
2	N/A	453010100380R	CABLE,D-SUB 15P MALE 6FT BLACK/BLUE, ROH	1
3	CB-00008190	453030300370R	CABLE,DVI-D 18+1P MALE 6FT BLACK , ROHS	1
4	A-00006733	453070800480R	PWRCORD 7A/125V BLK 6FT CNS VCTF 3Gx0.75	1
5	P-00008603	506040003500R	CUSHION,LEFT,LE2280	1
6	P-00008606	506020017700R	CARTON LE2275(VA2226w)	1
7	A-00005255	453070800170R	PWRCORD 10A/250V BLK 6FT	1
8	P-00008604	506040003510R	CUSHION,RIGHT,LE2280	1
9	C-00008567	714020002200R	ASSY,BASE, LE2082 ROHS	1
10	P-00008601	506120004010R	BAG,PLASTIC,W300xL250xT0.05mm	1
11	DC-00008552	703000008100R	KIT ACCESSORY LE2275(VA2226W)	1

11. Recommended Spare Parts List

RECOMMENDED SPARE PARTS LIST (VA2226w-1)

ViewSonic Model Number: VS11803

Serial No. Prefix: QQK

Rev: 1a

Item	Description	ECR/ECN	ViewSonic P/N	Ref. P/N	Location	Universal number#
1	Accessories:					
2	[Adapter, Remote Control;Power Cord]		A-00003671	453070800420R		
3			A-00003674	453070800210R		
4			A-00003675	453070800230R		
5			A-00005255	453070800170R		
6			A-00006733	453070800480R		
7			A-00006734	453070800500R		
8	PC Board					
9	Assembly: [All PCBA]					
10			B-00008382	790960500000R		
11			B-00008566	791031400000R		
12			B-00008567	791031500000R		
13			B-00008574	791031300600R		
14			B-00008575	791031300000R		
15			B-00008576	791031300700R		
16	Cabinets:					
17	[Front Panel, All Covers, Base Assembly]					
18			C-00008567	714020012200R		
19			C-00008570	501020216100R		
20			C-00008577	714030011200R		
21			C-00008578	714030011210R		
22			C-00008579	501020216000R		
23	Cables: [All Cables]					
24			CB-00008190	453030300370R		
25			CB-00008191	453010100310R		
26			CB-00008192	430303000840R		
27			CB-00008353	430300801250R		
28	Documentation:					
29			DC-00008552	703000008100R		
30	Electronic					
31			E-00006218	631102220040RV		
32	Components: [CRT-EEPROM, Fly Back]					
33			E-00008391	631102220151RV		
34			E-00008424	631102220091R		
35	Packing Material:					
36	[Box, Foam, Bags]					
37			P-00008419	506120300430R		
38			P-00008601	506120004010R		
39			P-00008603	506040003500R		
40			P-00008604	506040003510R		
41			P-00008606	506020017700R		
42	Plastics: [Pedestal,					
43			PL-00008187	714010005100R		

Remark 1: Above listed items are examples, supplier can expand the rows to add more necessary items.

Remark 2: All revised RSPLs with newly added items or any change made should be highlighted and correlated with the ECN/ECR approved by ViewSonic Corporation. This is to eliminate repeated cross checks of each item between this version and prior versions.

BOM LIST (VA2226w-1)

ViewSonic Model Number: VS11803

Rev: 1a

Serial No. Prefix: QQK

Item	ViewSonic P/N	Ref. P/N	Description	Location	Universal number#	Q'ty
1	N/A	506380002100R	TAPE WRAPPING TYPE(VIEWSONIC) 50mmx75M L			0.713
2	N/A	506431000300R	FILM,PE 500mmx900M ROHS			0.2
3	N/A	506039000101R	CORNER PAPER 1000x50x50xT3mmLE1711			2.778
4	N/A	506039002200R	CORNER PAPER 1850x50x50xT5mm LE1705			5.556
5	N/A	506039006200R	CORNER PAPER 1100x50x50xT3mm LE1513 ROH			2.778
6	N/A	506038004800R	CARDBOARD L1150xW1110xT4mm ROHS LP1909			2.778
7	N/A	506150009600R	PALLET,L1162xW1140xH120mm,LE2280			1.389
8	P-00008604	506040003510R	CUSHION,RIGHT, LE2280			100
9	P-00008603	506040003500R	CUSHION,LEFT, LE2280			100
10	P-00008601	506120004010R	BAG PLASTIC L300xW250xT0.05mm			100
11	P-00008419	506120300430R	BAG EPE+PO L590xW530xT0.6mm(PRINTED)LE22			100
12	P-00008606	506020017700R	CARTON LE2275(VA2226w)			100
13	CB-00008191	453010100310R	CABLE D-SUB 15P MALE 6FT BLACK/BLUE ROH			100
14	A-00008111	453070800150R	PWR CORD 10A/125V BLK 6FT UL/CSA SVT 3Cx			100
15	CB-00008190	453030300370R	CABLE,DVI-D 18+1P MALE 6FT BLACK , ROHS			100
16	N/A	505040207600R	INSULATOR,PET,490x313x0.1mm,LE2280#			100
17	N/A	506250016600R	LABEL AGENCY LE2275(VA2226w)			100
18	DC-00008552	703000008100R	KIT ACCESSORY LE2275(VA2226W)			100
19	N/A	714070E01000R	ASSY_FINAL(B+S)W/O SPK,LE2275-012(VA2216			100
20	N/A	506440002300R	LABEL,BLANK,76.2x76.2mm,LE1709(UPC)			100
21	N/A	506440002400R	LABEL,BLANK,50x25mm,LE1709(S/N)			100
22	N/A	506390500100R	LABEL,ENERGY STAR, LE1709			100
23	N/A	506390000600R	LABEL,HI-POT PASS, LE1709			100
24	N/A	506440002600R	LABEL,BLANK,210x65mm,LE1709(PALLET)			2.78
25	DC-00008552	703000008100R	KIT ACCESSORY LE2275(VA2226W)			
26	N/A	506070110600R	MNL USER'S(CD),LE2275(VA2226W)			100
27	N/A	506280105400R	QUICK SETUP GUIDE CASA(DUAL)LE2081			100
28	N/A	506420404100R	INSERT SHEET CASA 1680*1050			100
29	N/A	506420404200R	BASE ATTCHMENT CASA			100
30	N/A	714070E01000R	ASSY_FINAL(B+S)W/O SPK,LE2275-012(VA2216			
31	N/A	503040000600R	RUBBER_COVER BLACK LE2082			400
32	N/A	509116608510R	SCREW,P,CROSS,M4*8,BLACK,NL(NYLOK)			400
33	C-00008570	501020216100R	HINGE_COVER,LE2082			100
34	PL-00008187	714010005100R	ASSY_STAND,LE2082 ROHS			100
35	C-00008567	714020002200R	ASSY_BASE, LE2082 ROHS			100
36	N/A	714050010300R	ASSY_BACK_Asm,W/DVI,LE2275			100
37	C-00008578	714030011210R	ASSY_BEZEL,ASM,CPT,,LE2275			100
38	N/A	714080E01000R	ASSY_PANEL,W/O SPK,LE2275-012(VA2216W)			100
39	PL-00008187	714010005100R	ASSY_STAND,LE2082 ROHS			
40	N/A	501260206000R	STAND,LE2082			100
41	N/A	501040200600R	CLIP,CABLE,LE2082			200
42	N/A	502060300800R	HINGE,LE2082			100
43	N/A	509412608500R	SCREW,B,CROSS,T.T-4*8,BLK ROHS			300
44	C-00008567	714020002200R	ASSY_BASE, LE2082 ROHS			
45	N/A	501020215600R	COVER,BASE, LE2082			100
46	N/A	503020002710R	RUBBER FOOT L14.8*W9.6*T3.5mm (PATTERN)R			600
47	N/A	714050010300R	ASSY_BACK_Asm,W/DVI,LE2275			
48	C-00008579	501020216000R	COVER_BACK,W/DVI,LE2275			100
49	N/A	506431000400R	FILM,PET,L135xW30xT0.05mm,ROHS			100
50	C-00008578	714030011210R	ASSY_BEZEL,ASM,CPT,,LE2275			
51	N/A	501010200710R	BEZEL,CPT,LE2275			100
52	N/A	501010211400R	BEZEL_COVER,Down,LE2280			100
53	N/A	501030207300R	BUTTON,KEY,LE2280 ROHS			100
54	N/A	501120106400R	LENS,LE2280			100
55	N/A	506102000300R	LOGO PLATE VIEWSONIC LE1709			100
56	N/A	501110601000R	LOGO THREE BRIDS 7.9MM LE2082			100
57	N/A	714080E01000R	ASSY_PANEL,W/O SPK,LE2275-012(VA2216W)			
58	HW-00005269	509146305300R	SCREW,PW,CROSS,W/WAS,M3*5,NI			400
59	N/A	509146306102R	SCREW,P,CROSS W/W-SPR,M3*6,Zn,ROHS			100
60	N/A	701000004800R	ASSY_CHASSIS,W/DVI, LE2275			100
61	N/A	511150102610R	FOIL,AL.,DOUBLE COND.,RIGHT,LE2239			100
62	N/A	511150102600R	FOIL,AL.,DOUBLE COND.LEFT,LE2239			100
63	HW-00005270	509000000700R	BOLT,#4-40x11.8,Ni FOR D-SUB/DVI CONN.RO			400
64	B-00008575	791031300000R	PCBA,I/F BOARD(A01,W/O SPK),LE2275-012 R			100
65	B-00008566	791031400000R	PCBA,P/I BOARD,W/O SPK,LE2275-012 ROHS			100
66	B-00008567	791031500000R	PCBA,KEYPAD BOARD,LE2275-012 ROHS			100
67	E-00008391	631102220151RV	LCP 22" CLAA220WA01(A)-000(CPT)			100

Item	ViewSonic P/N	Ref. P/N	Description	Location	Universal number#	Q'ty
68	N/A	631102220152RV	LCP 22" CLAA220WA01(A)-011(CPT)			
69	CB-00008192	430303000840R	HRN LVDS FFC 30P 187mm ROHS			100
70	CB-00008353	430300801250R	HRN ASS'Y 8P 185mm UL1571#28,RoHS			100
71	N/A	503060005800R	GASKET,EMI,L80xW10xH6.5mm,LE2280			100
72	N/A	511150101800R	FOIL,AL.,DOUBLE COND.,60x35xT0.07mm, LE2			100
73	N/A	503080001100R	RUBBER, SILICON, THERMAL CONDUCT 45x10xt			100
74	N/A	701000004800R	ASSY,CHASSIS,W/DVI, LE2275			
75	N/A	502090307300R	CHASSIS,W/DVI,LE2275,ROHS			100
76	N/A	502080000200R	SUPPORT,HINGE,LE2280			100

* *Reader's Response* *

Dear Readers:

Thank you in advance for your feedback on our Service Manual, which allows continuous improvement of our products. We would appreciate your completion of the Assessment Matrix below, for return to ViewSonic Corporation.

Assessment

A. What do you think about the content of this Service Manual?

<i>Unit</i>	<i>Excellent</i>	<i>Good</i>	<i>Fair</i>	<i>Bad</i>
1. Precautions and Safety Notices				
2. Specification				
3. Front Panel Function Control Description				
4. Circuit Description				
5. Adjustment Procedure				
6. Troubleshooting Flow Chart				
7. Block Diagrams				
8. Schematic Diagrams				
9. PCB Layout Diagrams				
10. Exploded Diagram and Exploded Parts List				
11. Recommended Spare Parts List				

B. Are you satisfied with this Service Manual?

<i>Item</i>	<i>Excellent</i>	<i>Good</i>	<i>Fair</i>	<i>Bad</i>
1. Service Manual Content				
2. Service Manual Layout				
3. The form and listing				

C. Do you have any other opinions or suggestions regarding this service manual?

Reader's basic data:

Name:		Title:	
Company:			
Add:			
Tel:		Fax:	
E-mail:			

After completing this form, please return it to ViewSonic Quality Assurance in the USA at facsimile 1-909-839-7943. You may also e-mail any suggestions to the Director, Quality Systems & Processes (marc.maupin@viewsonic.com)